

Booklet available in English on
Heft in deutscher Sprache erhältlich auf
Livret disponible en français sur
Libretto disponibile in Italiano su
Folleto disponible en español en
如需中文版手册, 请访问

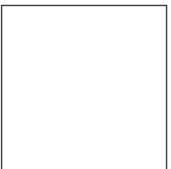

INDIANA JONES™



RAIDERS
100%™

"Let us help,
there is nothing
to fear here"

"That's what
scared me"

© 2008 LEGO

LEGO

LEGO



"It's not the years, honey. It's the mileage."

In 1981, a rugged-looking college professor ascended to the big screen and invited the world on a thrilling journey from jungle temples in Peru to the Egyptian desert in search of the mythical Ark of the Covenant.

From the first frame in *Indiana Jones and the Raiders of the Lost Ark*, Dr. Henry 'Indiana' Jones, Jr.TM, passionate archaeologist-slash-adventurer, captured the imaginations and hearts of would-be treasure hunters of all ages. Ever since, he has kept us on the edge of our seats with incredible whip-cracking action, witty dialogue, intricate plots and hard-hitting sidekicks. In a spectacular mix of mystery, myth and real-life historic events spanning from the mid-1930s to the 1950s, the unlikely protagonist finds creative ways to outmanoeuvre dastardly villains and dodge deadly booby traps. At every twist and turn, the centre of the stories are the passionate characters and relationships.

Over the years (and the mileage), Indiana Jones has excited generations of fans. With a thrilling series of feature films, a TV series, video games, theme park rides, novels and comics, no dust is likely to settle on this history professor's books anytime soon. And we keep coming back to revel in every detail.

Welcome to the jungle - enjoy building!



The Temple of the Golden Idol

More than 2,000 years old, the Temple of the Golden Idol is believed to guard the ancient Hovitos Warrior tribe's sacred relics, including a legendary gold idol of their most revered deity. Undeterred by the failures of previous expeditions and the betrayal of his sketchy hired helpers, Indiana Jones™ pursues the precious archaeological treasure at the behest of the National Museum.

Designed for warrior rite-of-passage rituals, and to protect it against intruders, the temple is riddled with treacherous booby traps, pitfalls, poisonous darts and, not least, a giant boulder. Armed with a ragged map and a talent for thinking on his feet, Jones eludes every obstacle until the final trap causes the temple to collapse. His arch-nemesis, fellow archaeologist René Belloq, snags the idol and Jones is forced to flee from the enraged Hovitos Warriors.

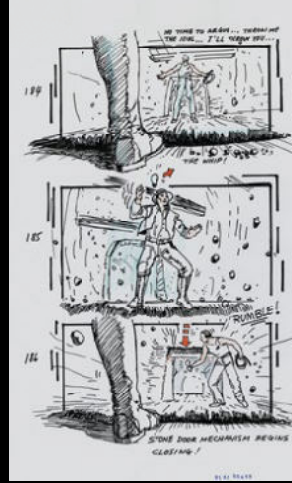

Original story boards and images © Lucasfilm Ltd.



The Return of the Great Adventure.

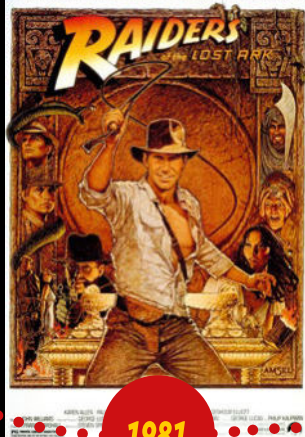

1981



Indiana Jones™ and his feisty ex-flame Marion Ravenwood™ dodge booby traps, fight Nazis and stare down snakes in their incredible worldwide quest for the mystical Ark of the Covenant.



1984



A mission to recover a sacred Indian Sankara Stone leads Jones and sidekicks Short Round™ and Willie Scott™ to the ancient Pankot Palace and the terrifying Thuggee cult.



1989



In search of his missing father (Professor Henry Jones, Sr.™), Indiana Jones teams up with the beautiful Dr. Elsa Schneider™ to rescue his father and locate the sacred Holy Grail before the Nazis do.



2008



Indiana Jones grudgingly reunites with Marion Ravenwood and son, Mutt Williams™, as they cross paths with a cunning Soviet military scientist obsessed with finding the Crystal Skull of Akator.

2023

To be continued...



Casper Glahder, Andrew Seenan, Harald Pofjahi.



LIGHTS, LEGO® BRICKS, ACTION

"This is one of the most iconic movie scenes of all time. It really encapsulates everything great about Indiana Jones™. Treasure-hunting adventures, booby-trapped temples and daring escapes! I grew up watching the original trilogy and was so proud to be part of bringing this LEGO® version to life. The LEGO Group has worked with Disney/Lucasfilm Ltd. on other franchises before and our team had a great experience collaborating with their passionate Indiana Jones expert. I hope fans will love the result."

- Andrew Seenan, LEGO® Creative Lead, Senior Design Manager

"I'm sure I wasn't the only Indiana Jones fan who used to build my own LEGO temples as a kid and challenge my friends to steal treasures! Designing this model felt like a continuation of that. We wanted to create a super detailed, playful display model full of functions, 'dangers' and surprises. All triggers are hidden in the decorative ornaments in the base to mimic the movie model and let you retrace Indy's treacherous path. I especially enjoy that last function with the spotlight, lowering the idol and collapsing the temple."

- Harald Pofahl, LEGO® Design Master

"I really looked forward to creating the graphics for the set. I looked at previous LEGO Indiana Jones minifigures for comparison, researched assets online and re-watched the movies to find inspiration for where we could add even more new details. We got great feedback and suggestions from Disney/Lucasfilm Ltd. as well, and I think we ended up with some really funny details, like the weird and goofy-looking faces in the wall decors, the spiders on Satipo's back and his terrified facial expression as a result!"

- Casper Glahder, LEGO® Graphic Designer

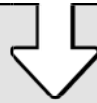



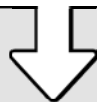



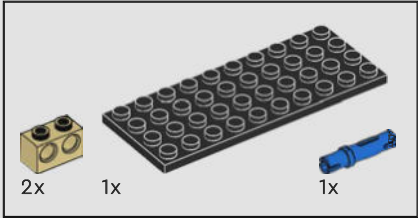

1

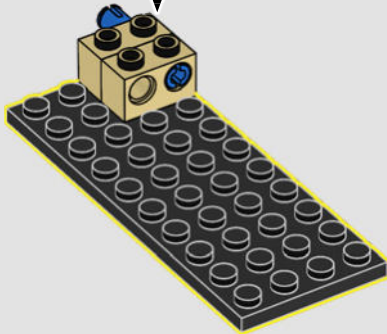
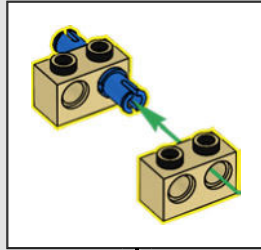

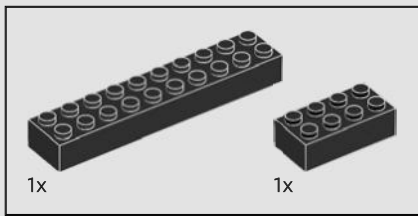

2

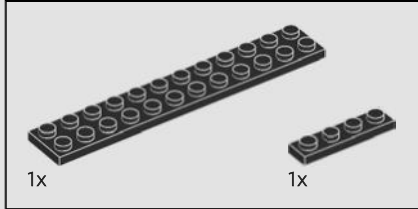
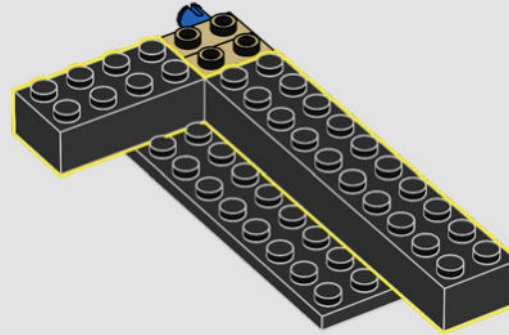

3

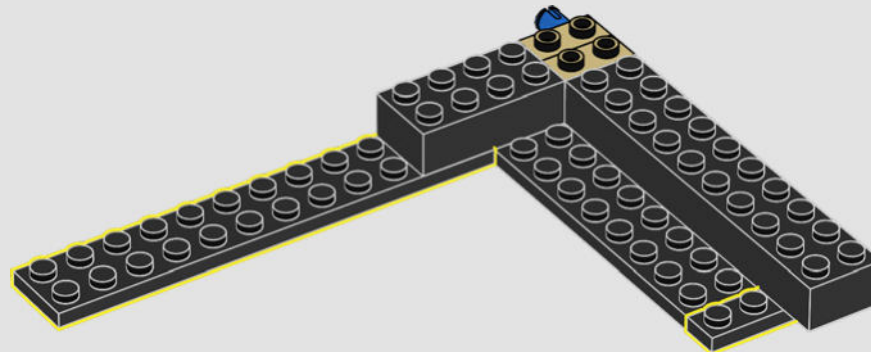

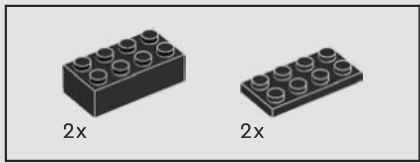

4

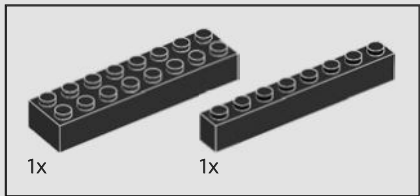
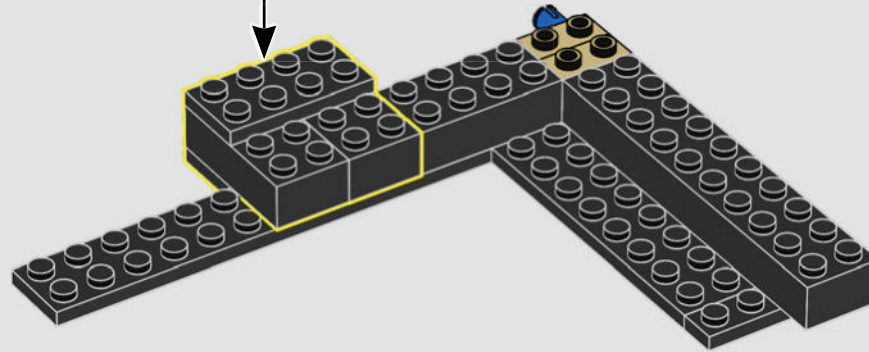
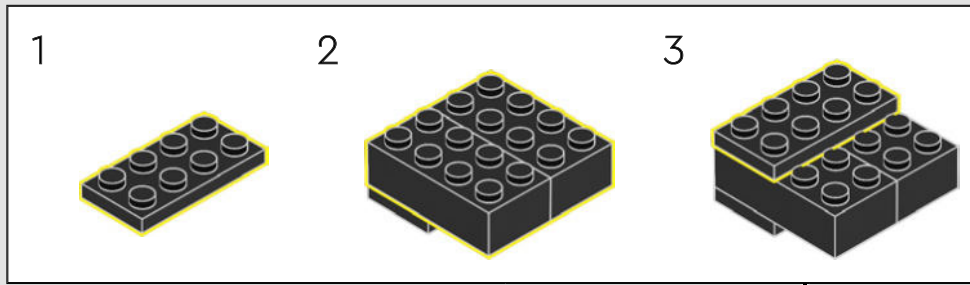

5

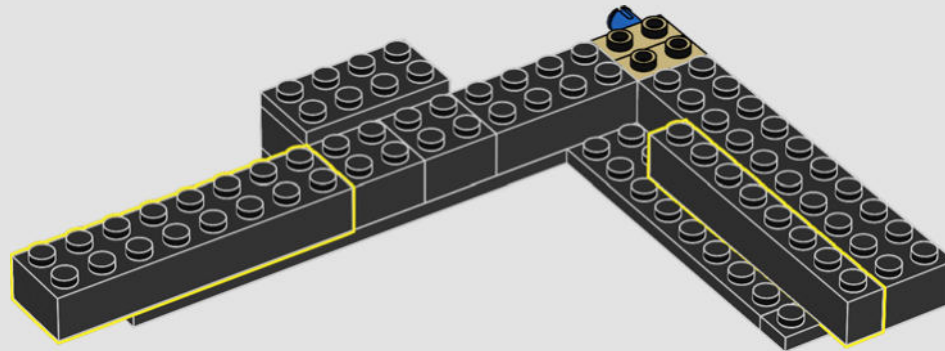

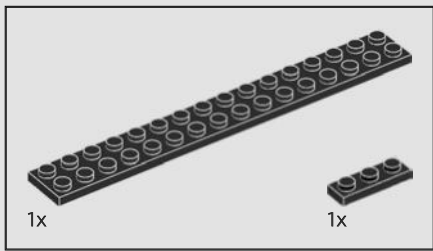

6

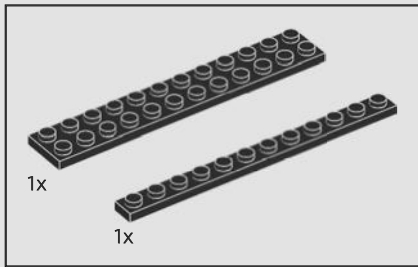
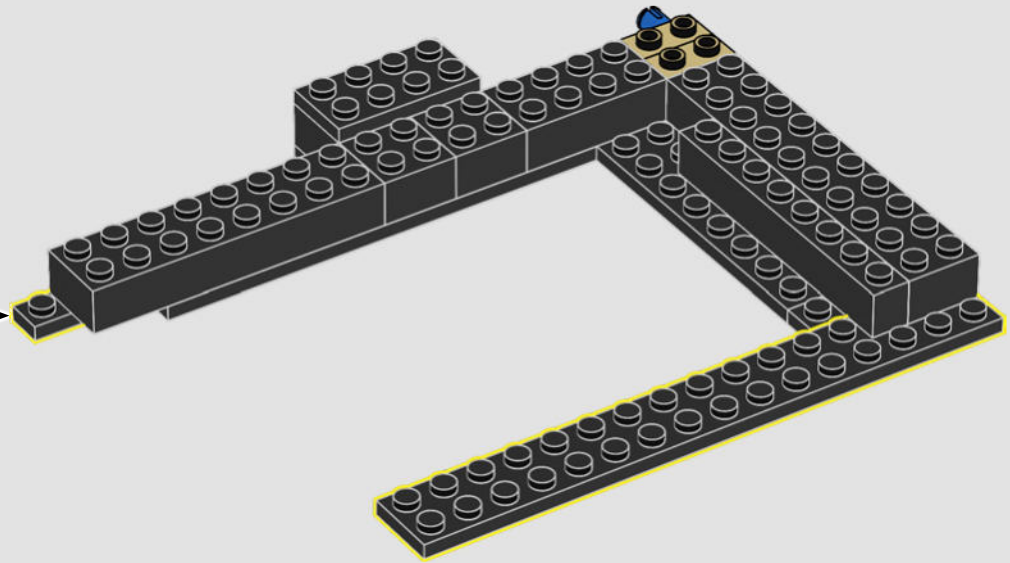
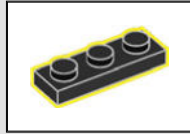

7

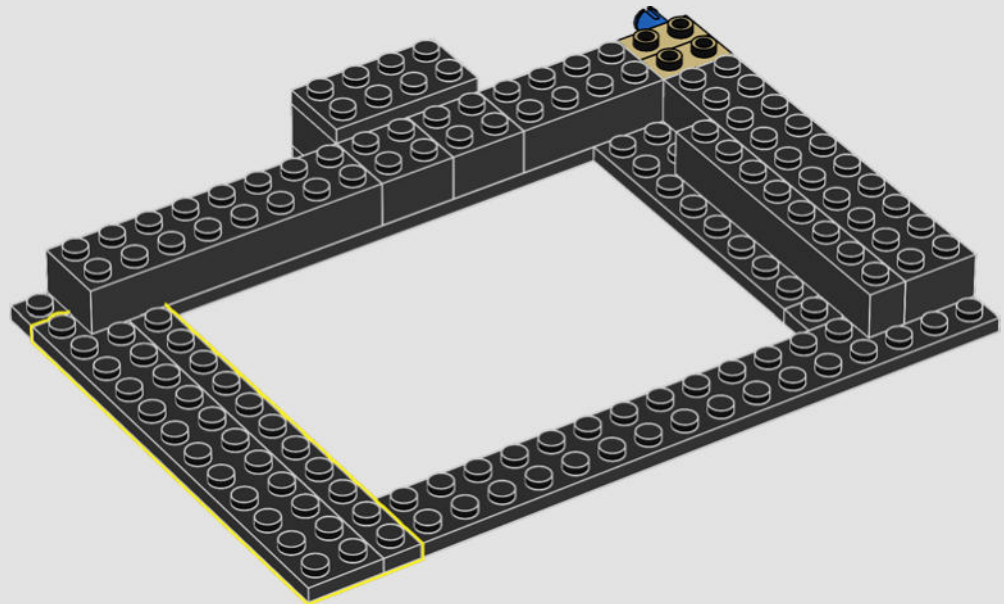

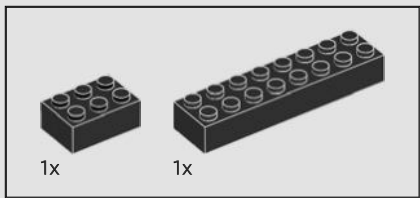

8

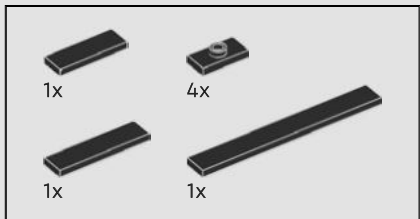
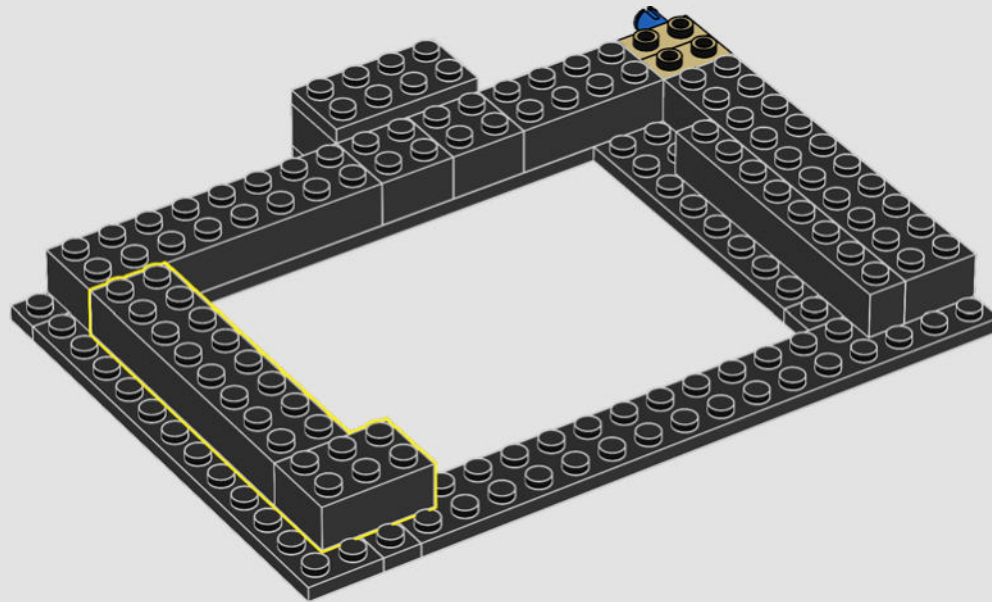

9

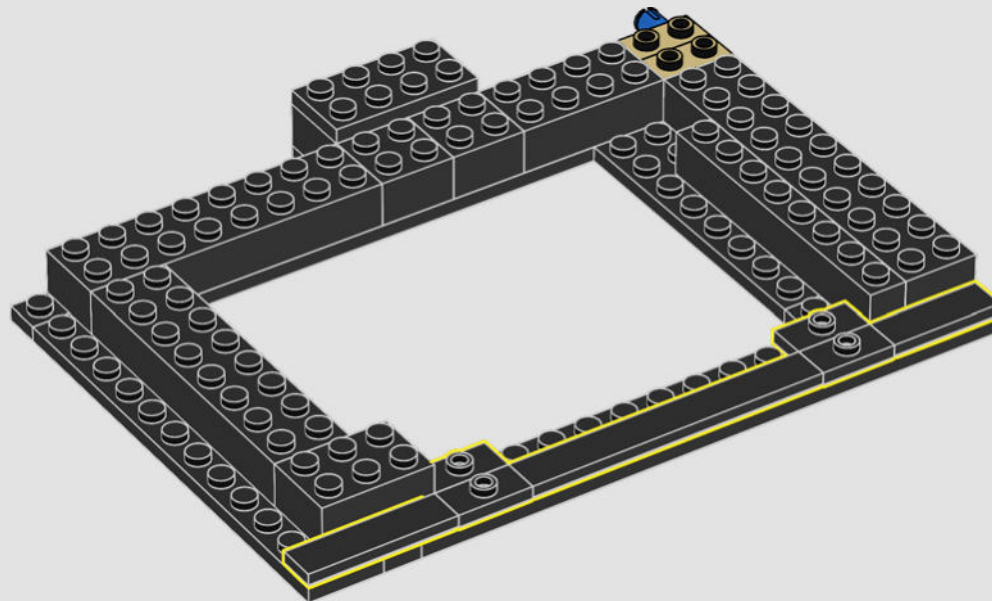

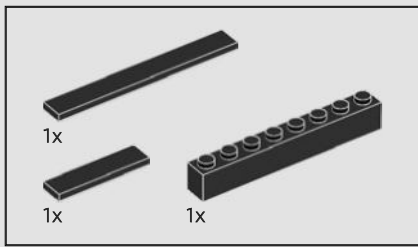

10

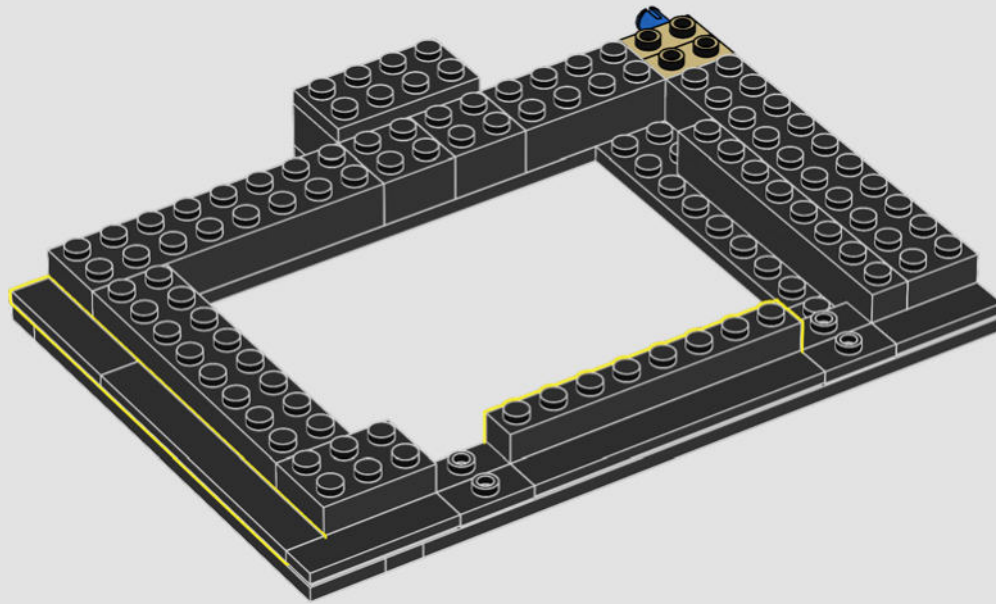

11

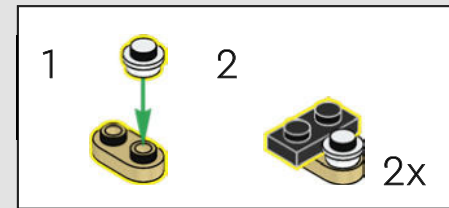
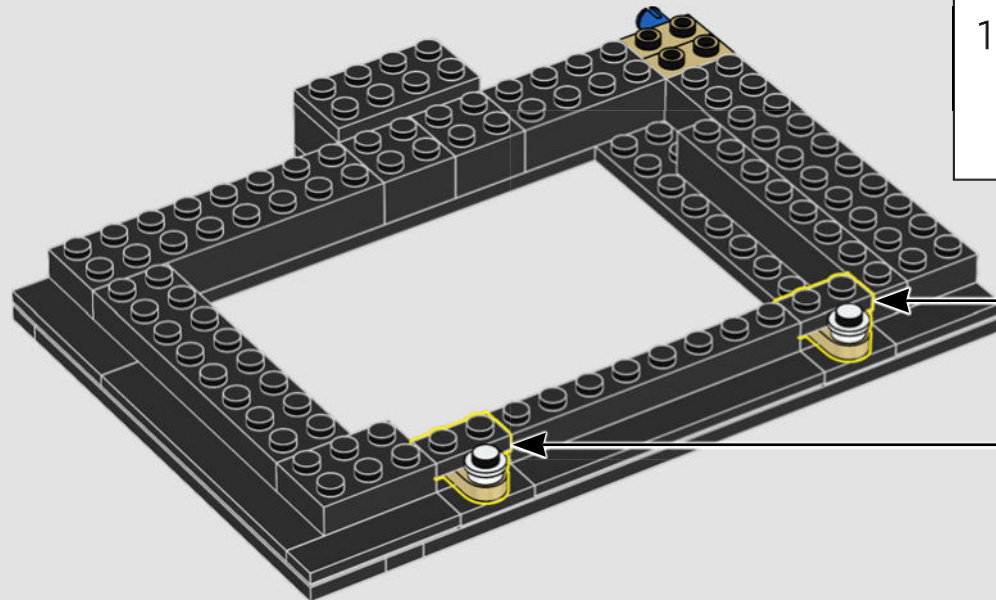

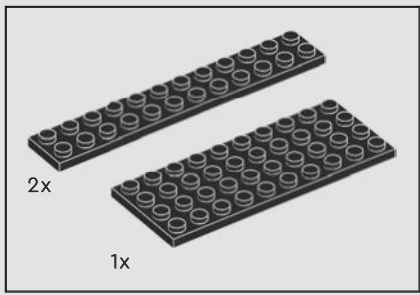

12

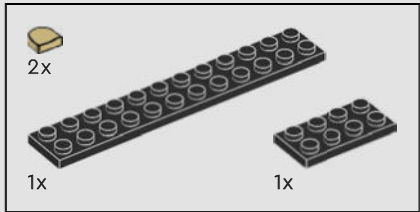
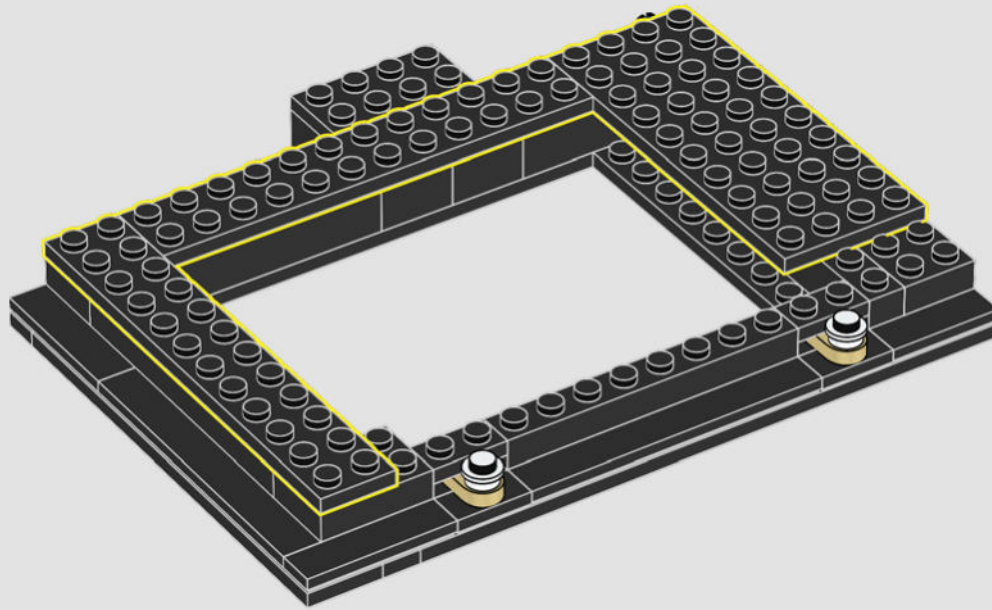

13

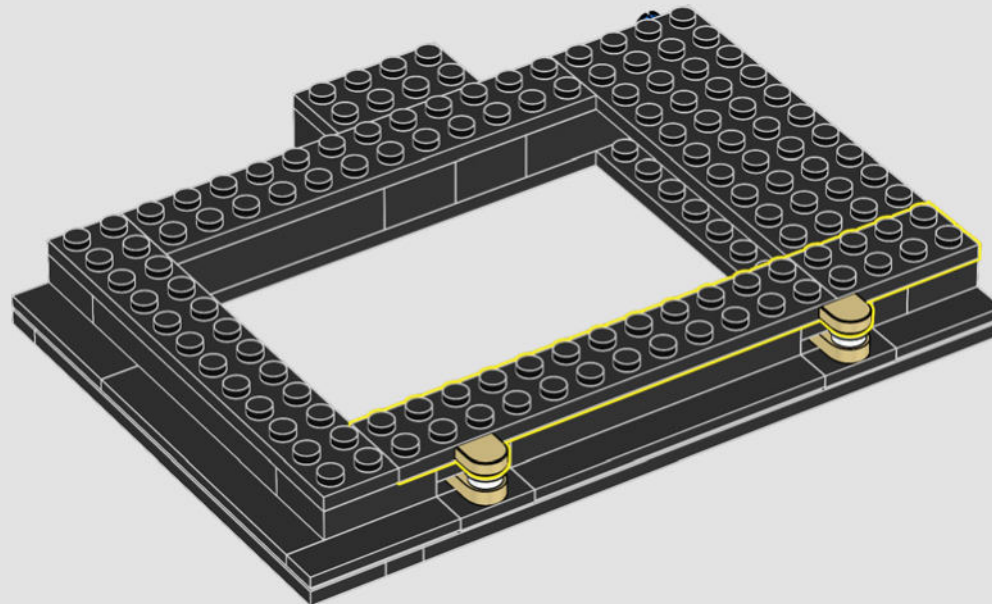

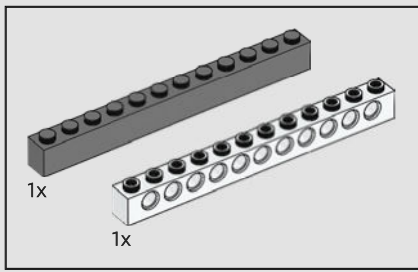

14

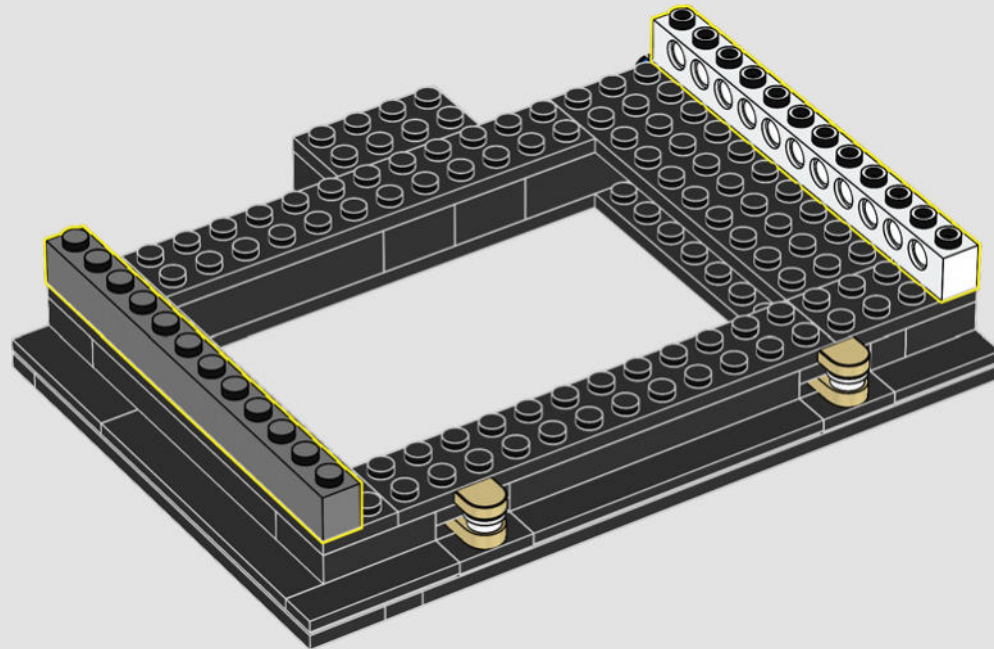

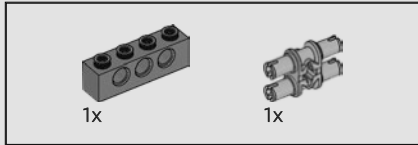
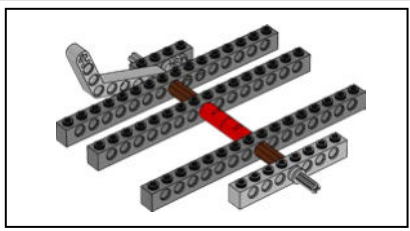

15

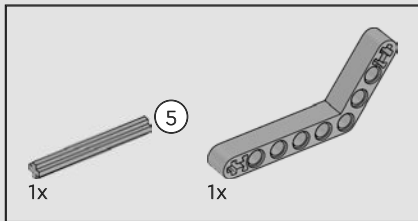
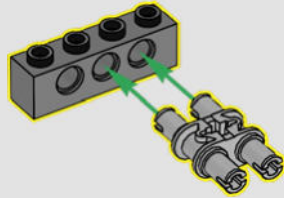

16

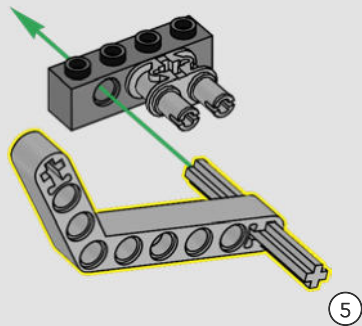

20

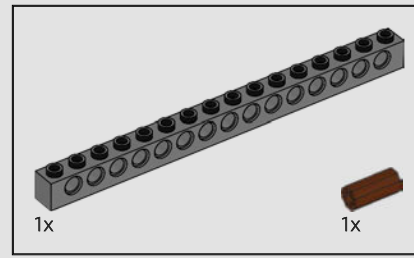
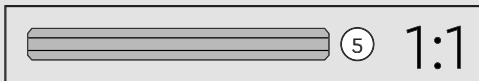

17

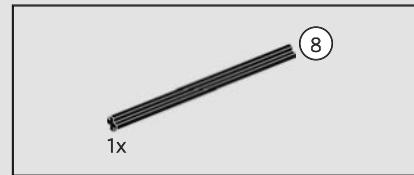
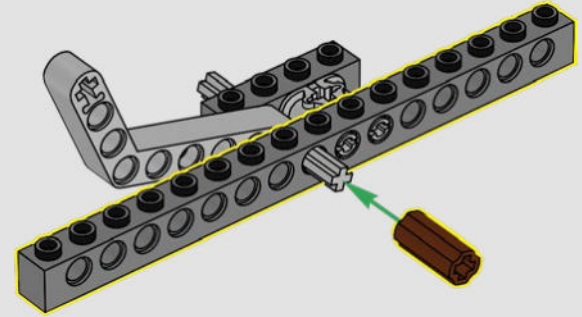

18

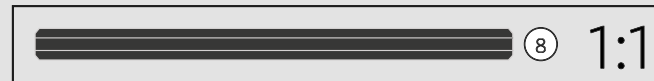
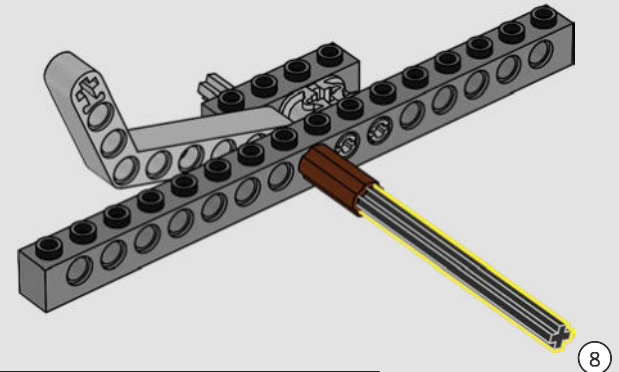

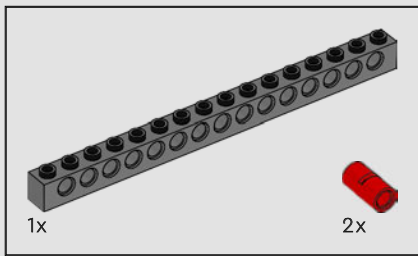

19

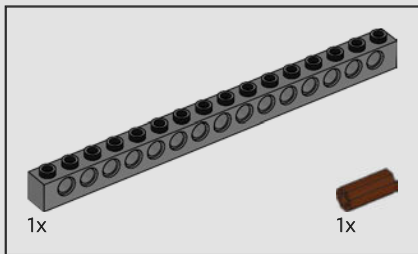
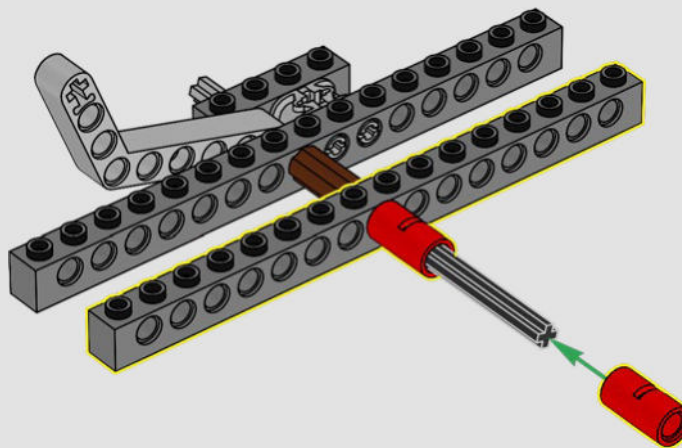

20

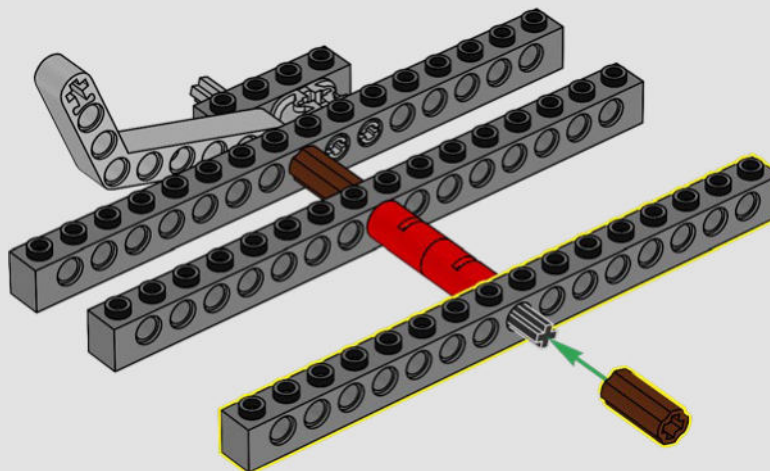

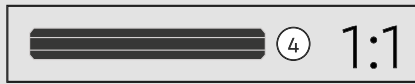
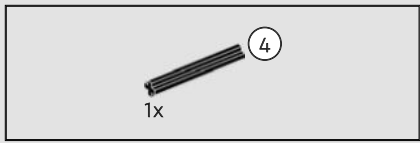

21

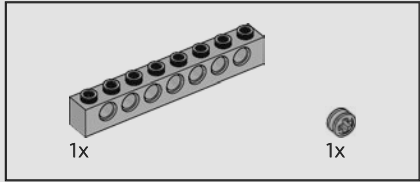
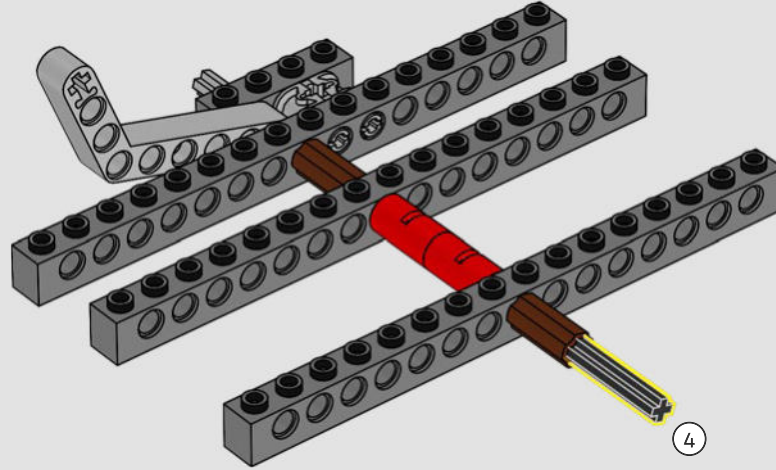

22

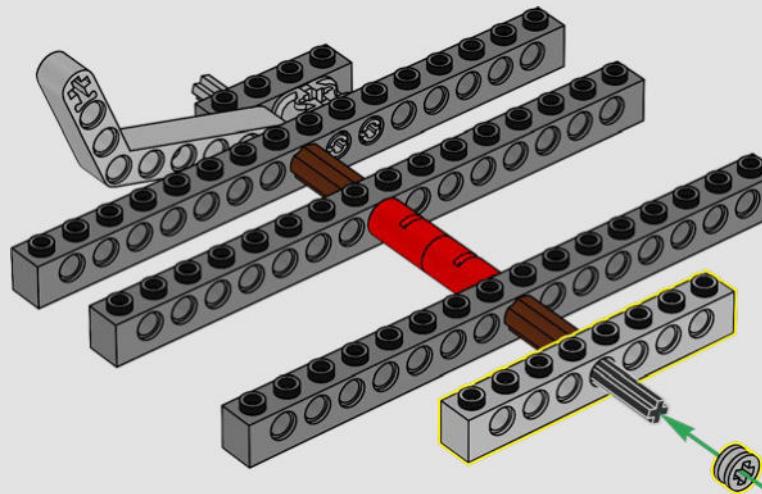

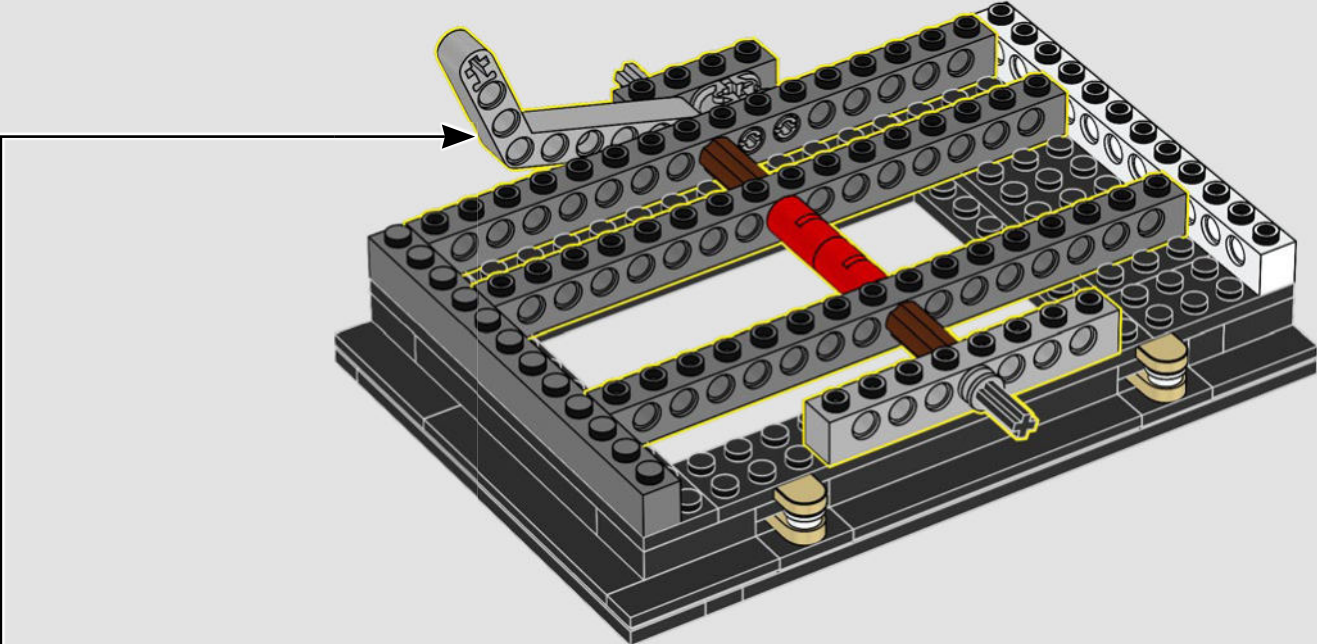

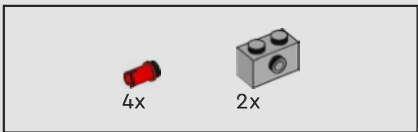

24

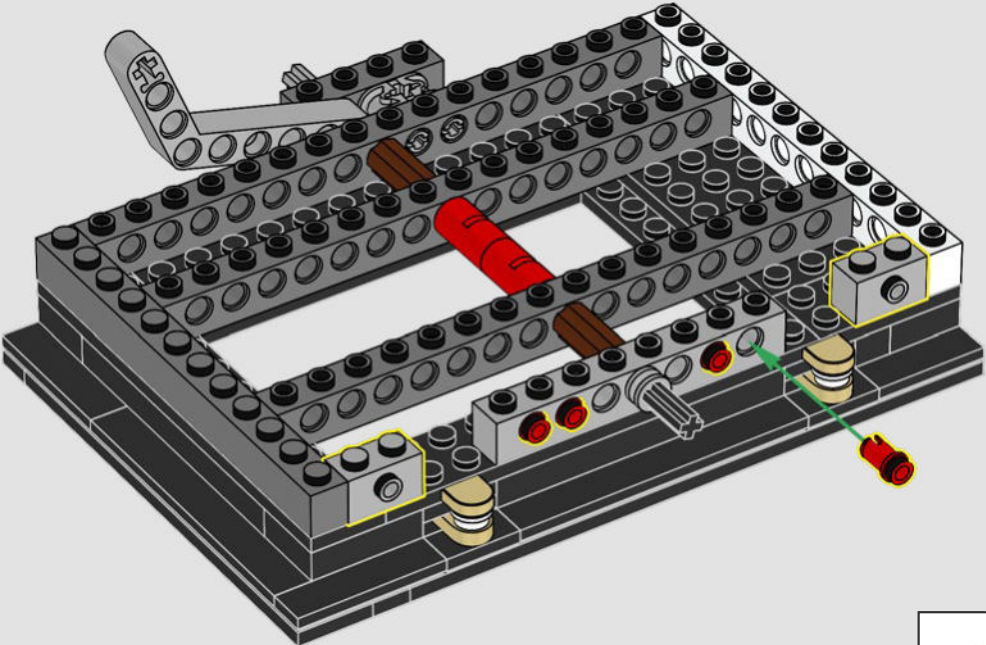

25

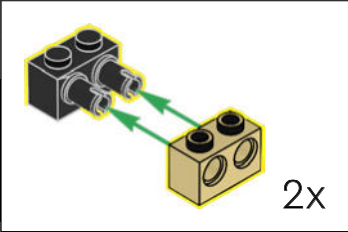
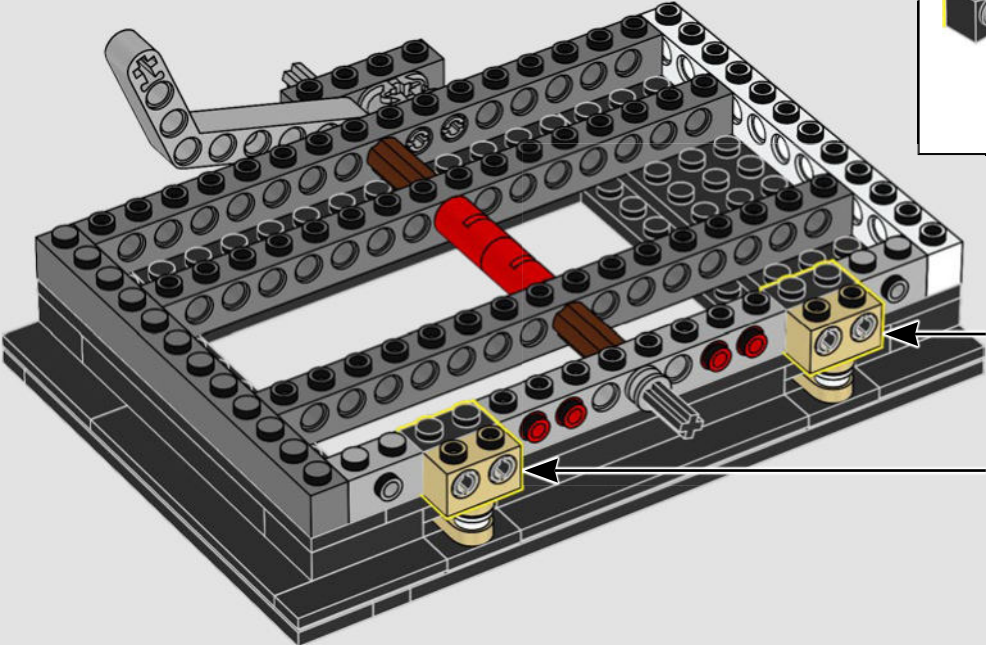

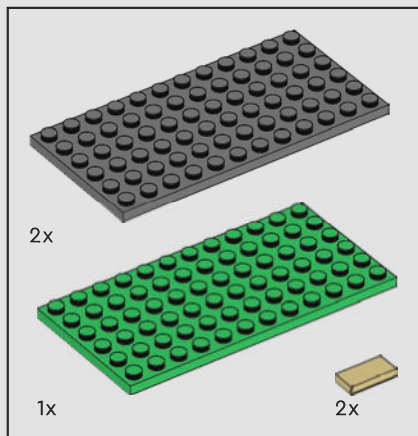

26

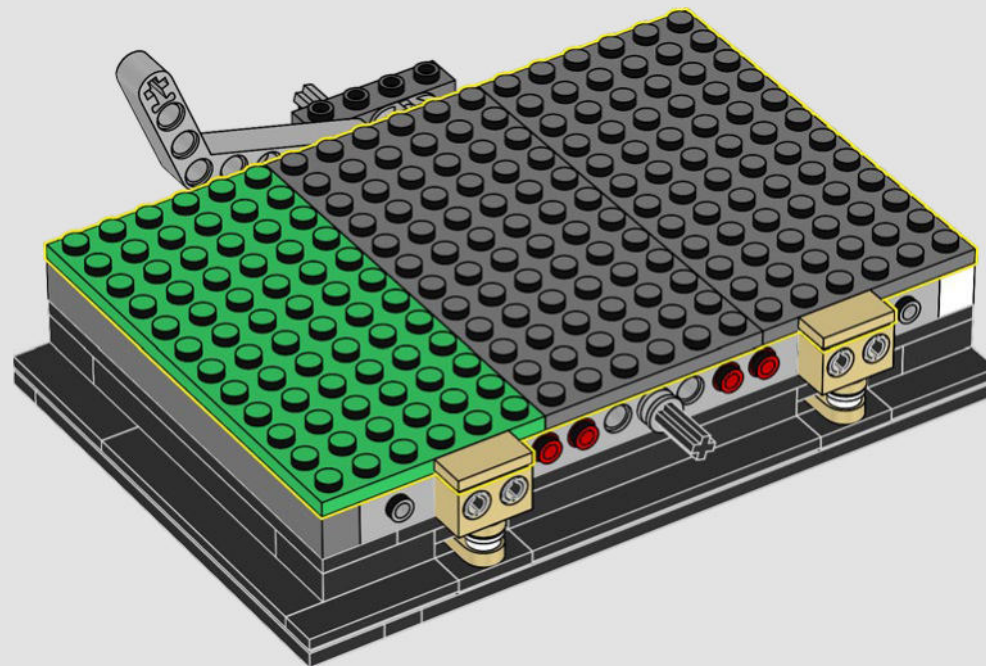

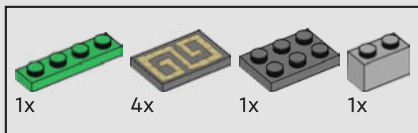

27

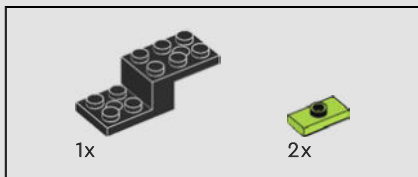
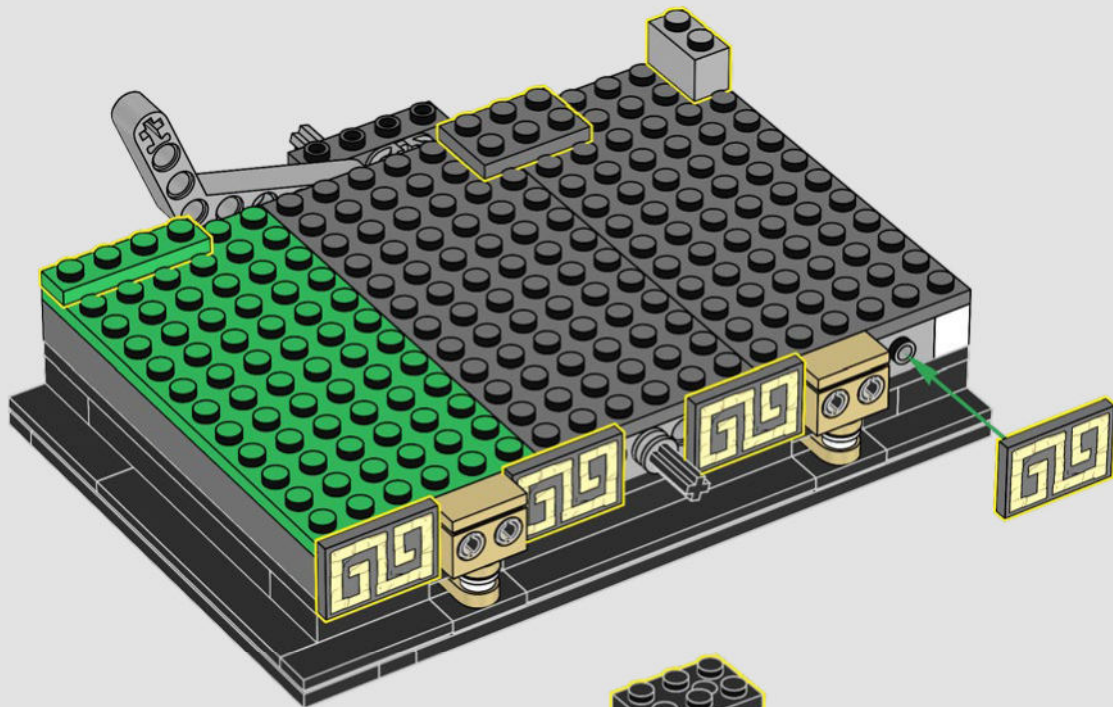

28

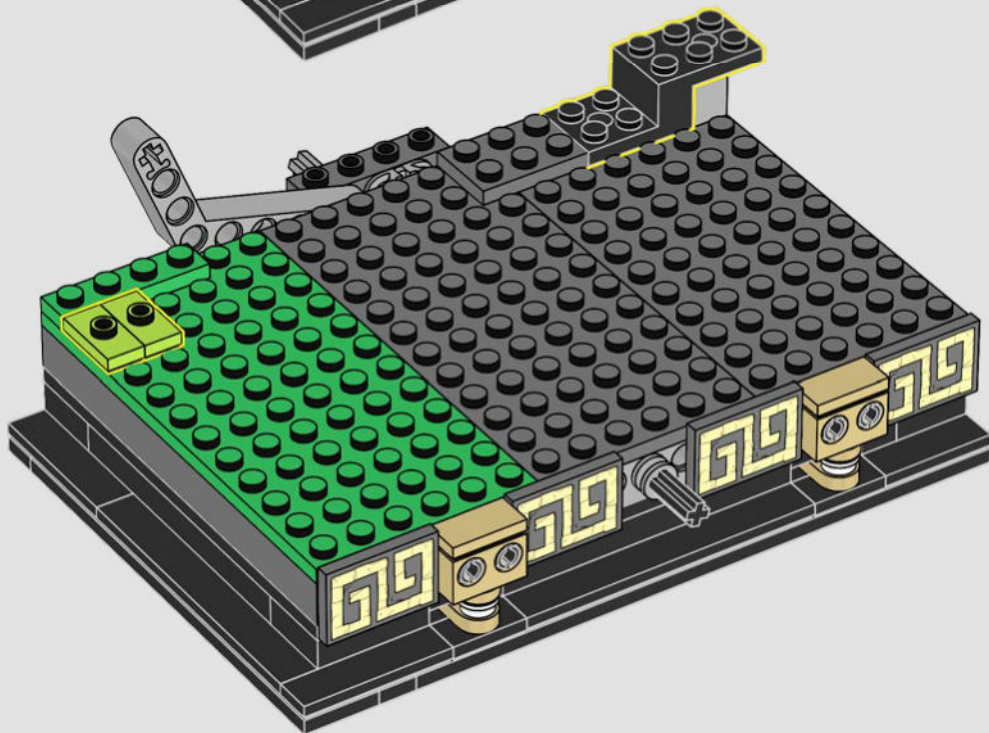

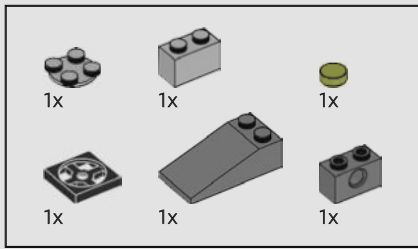

29

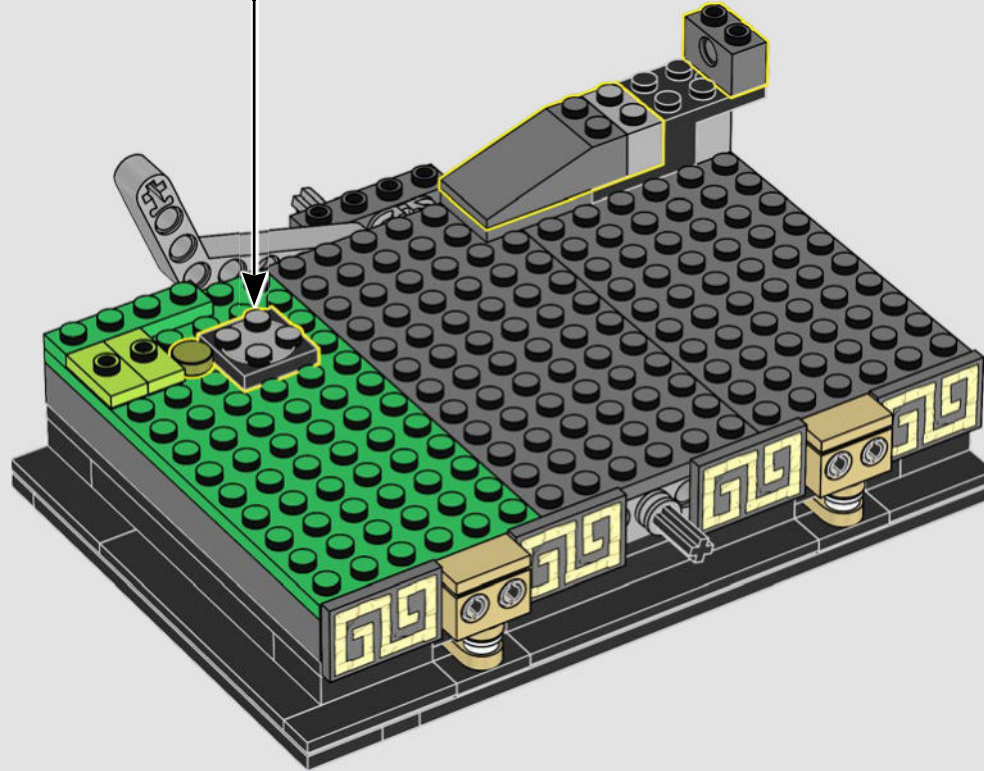
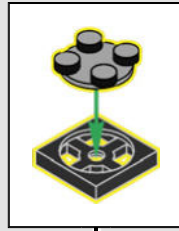

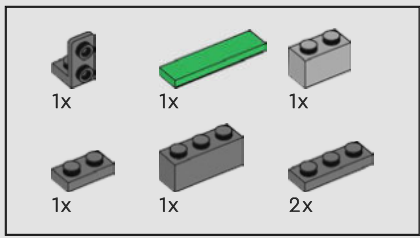

30

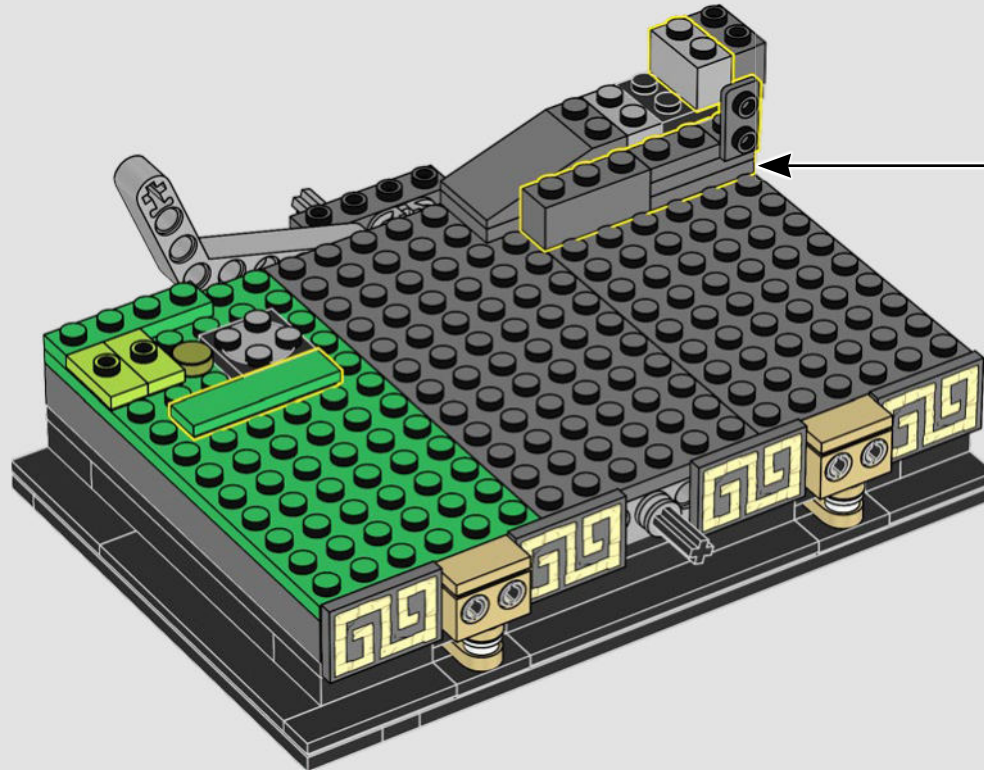
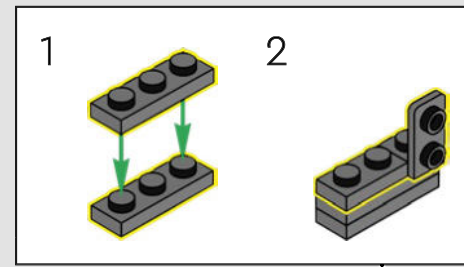

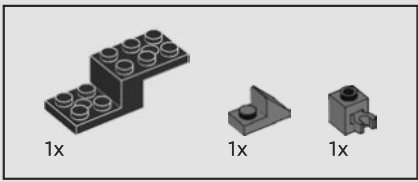

31

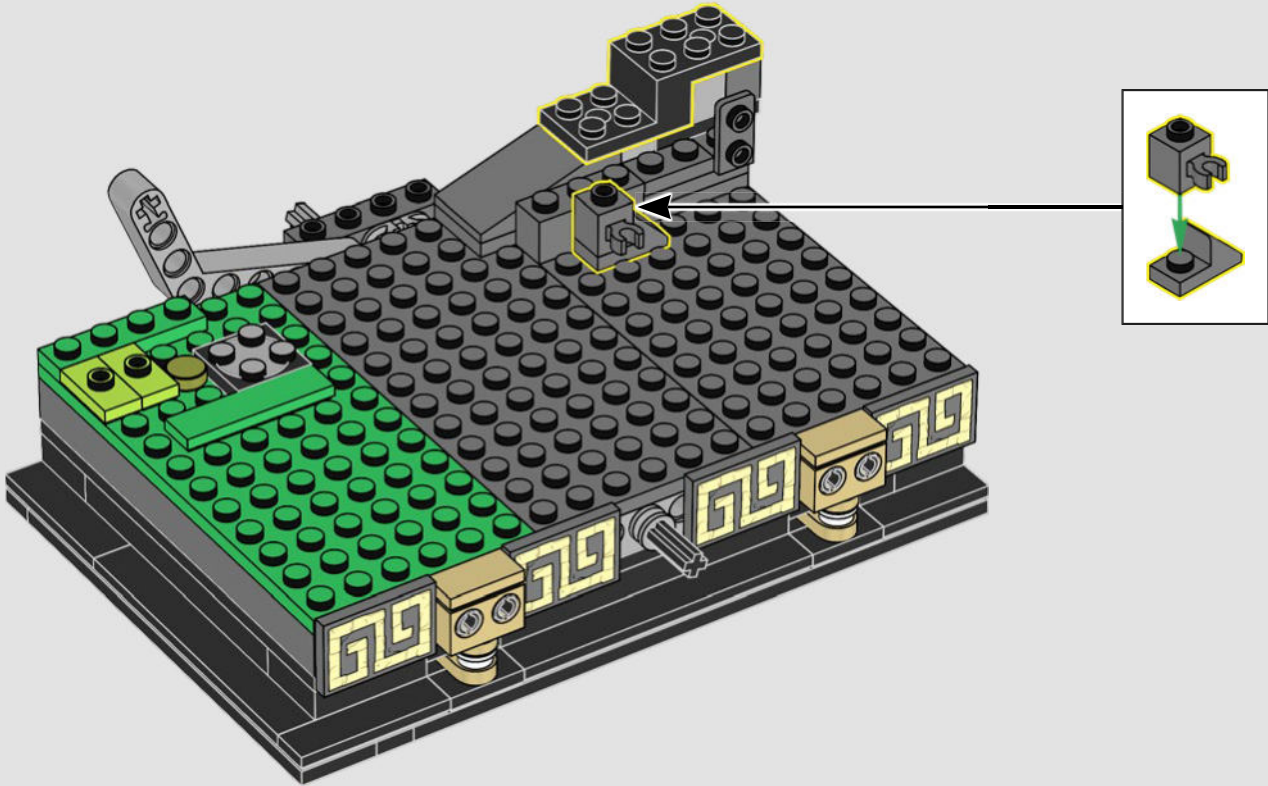

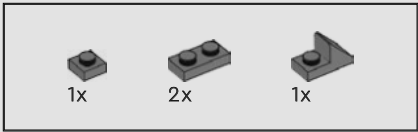

32

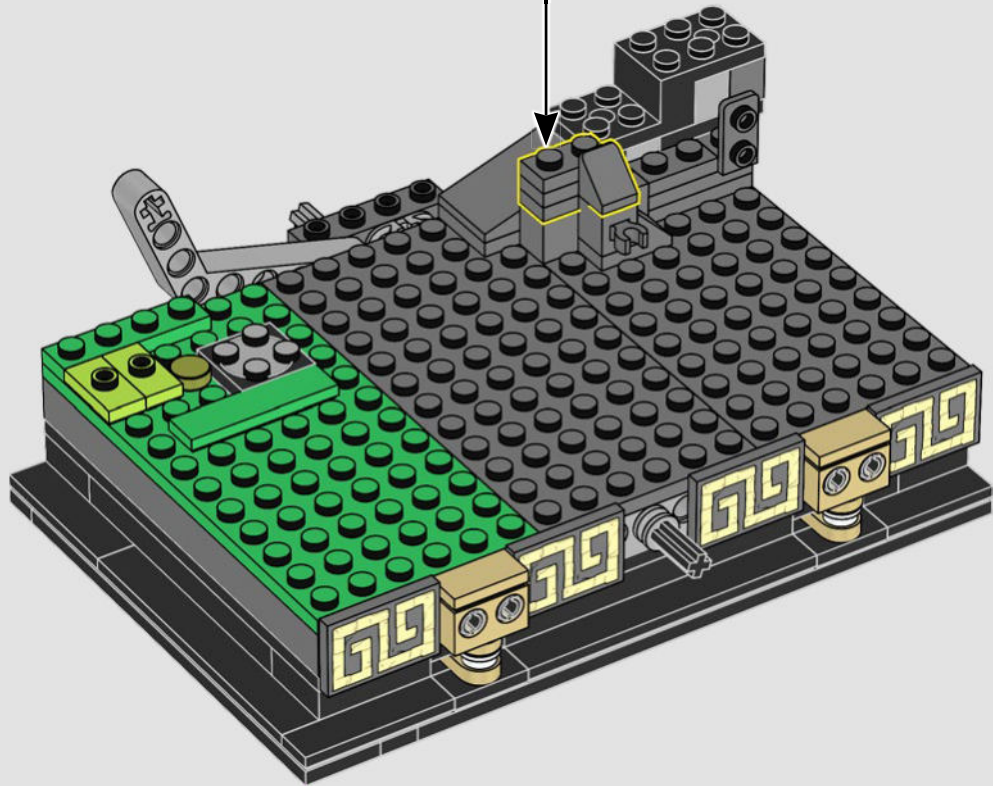
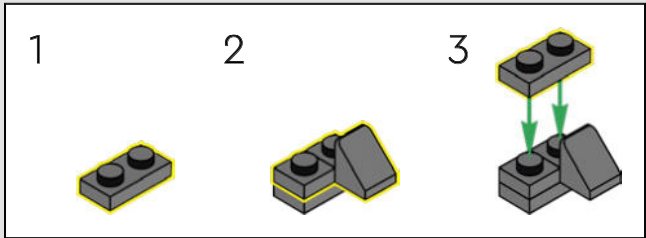

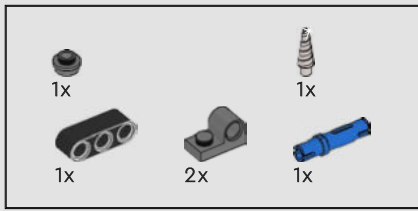

33

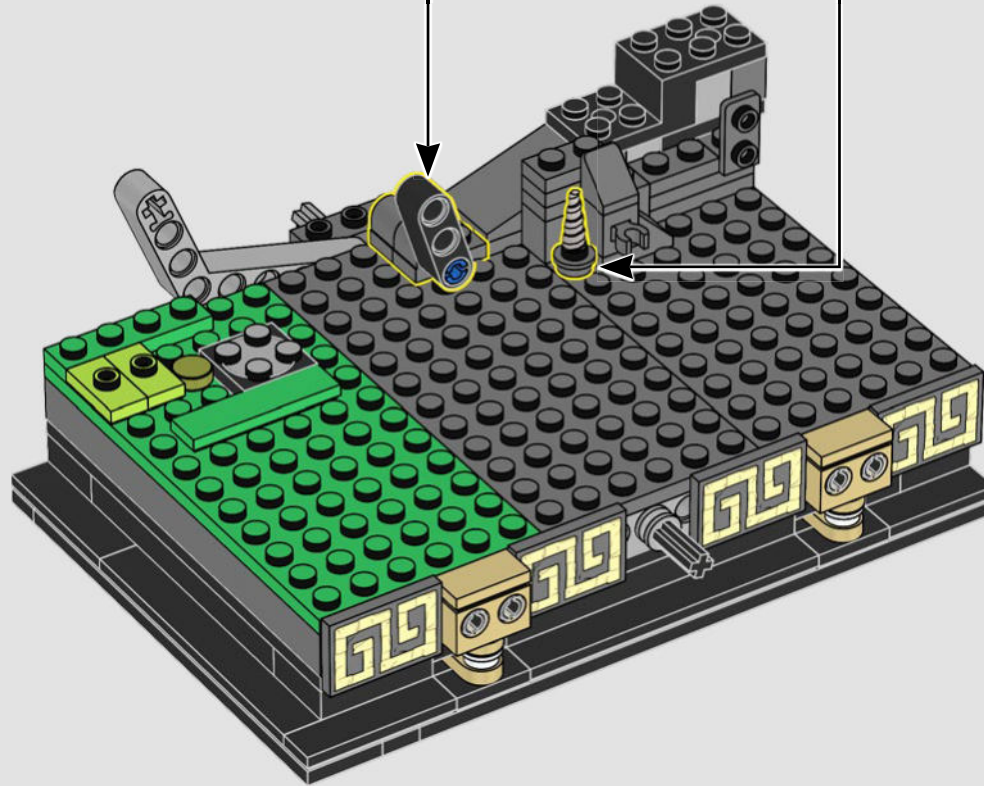
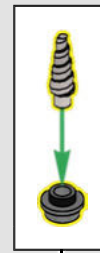
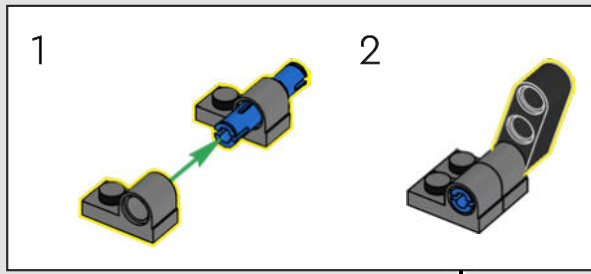

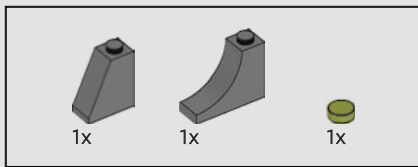

34

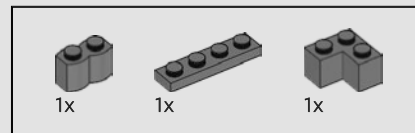
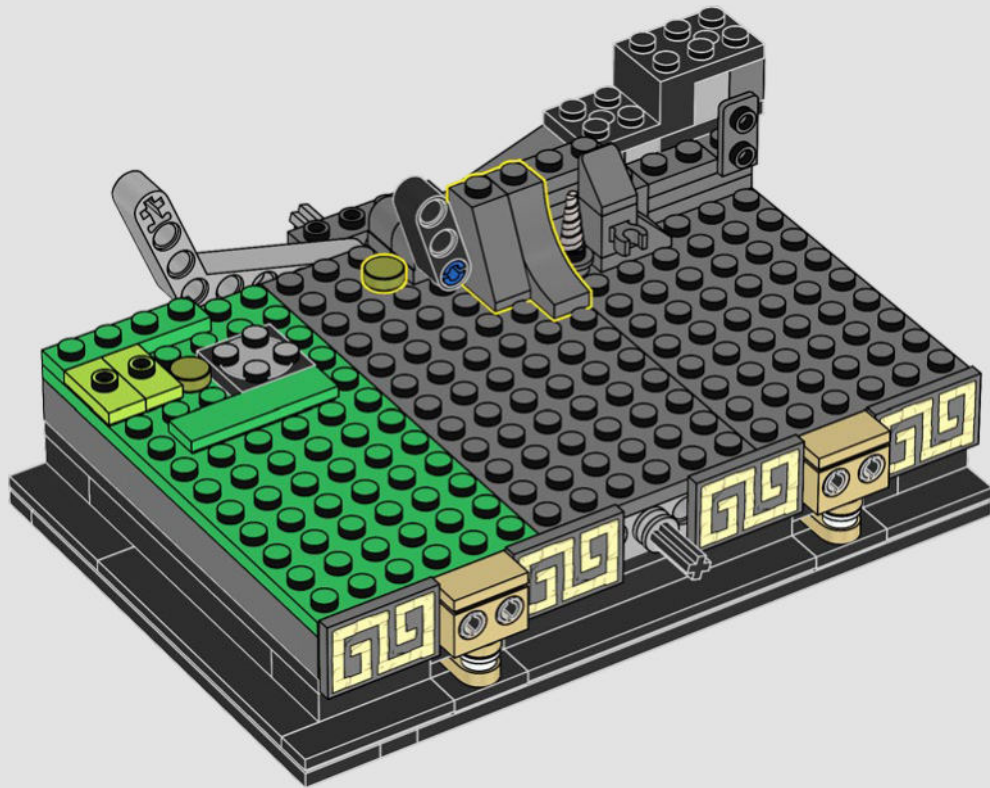

35

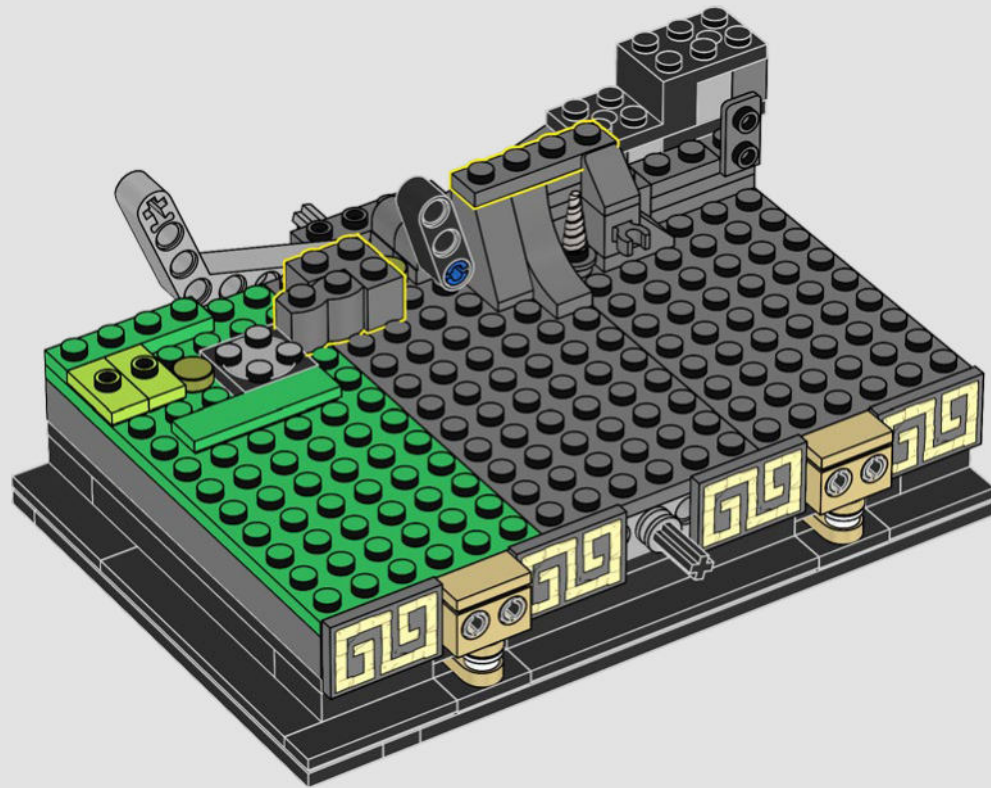

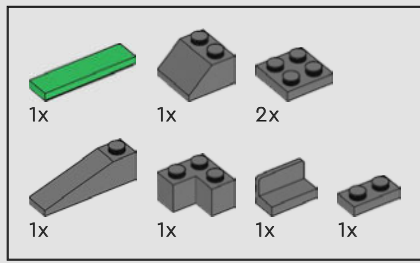

36

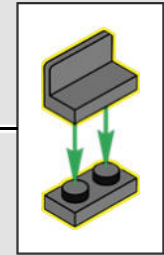
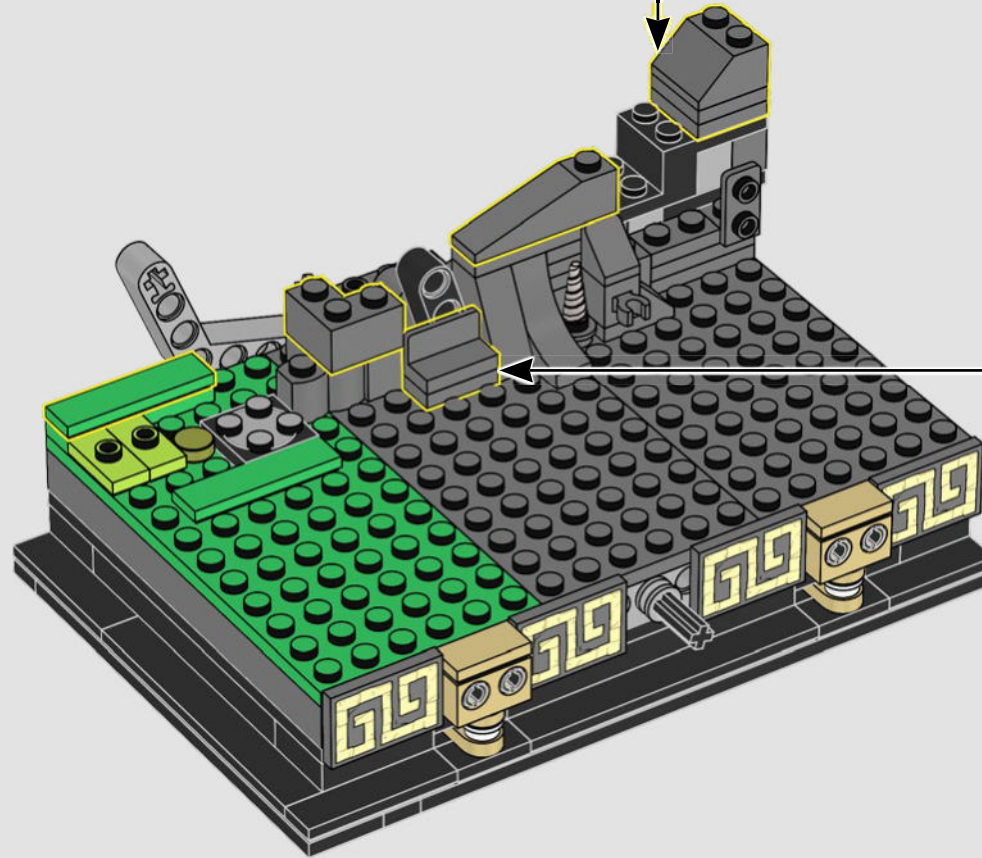
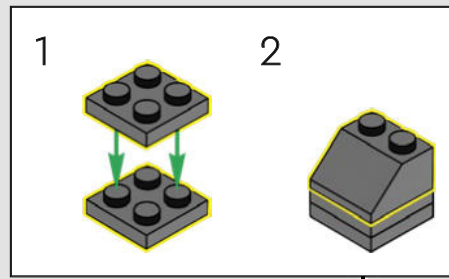

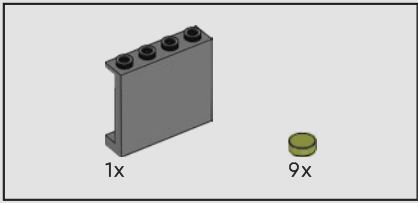

37

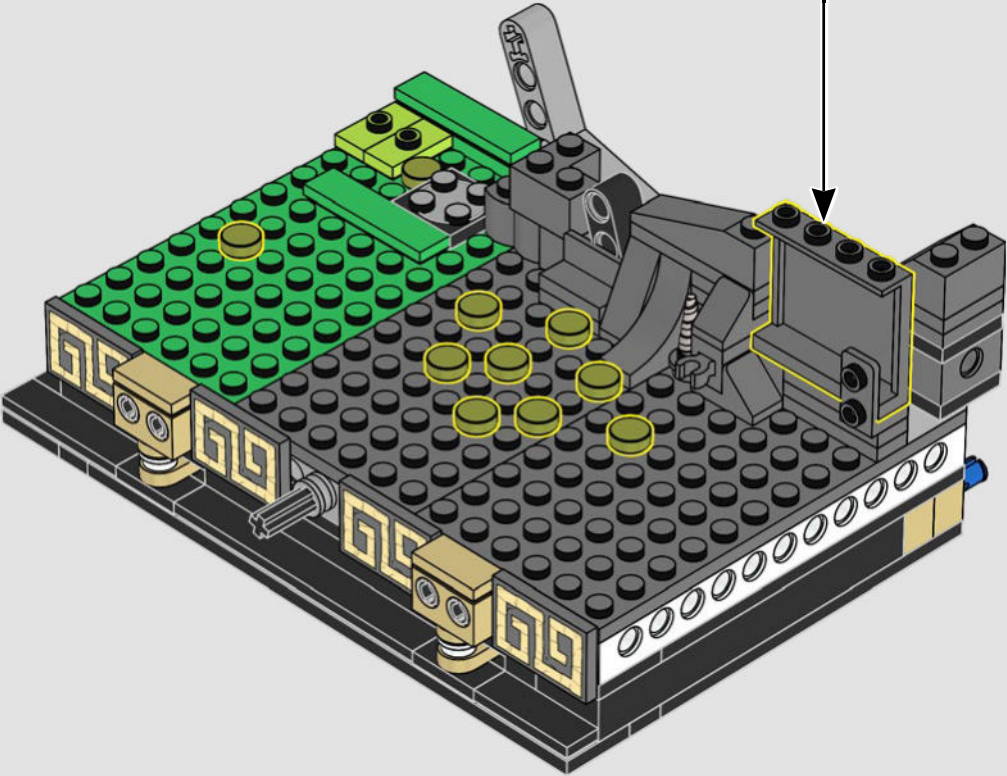
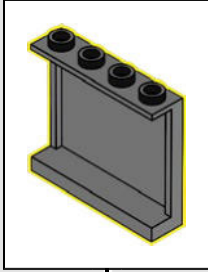

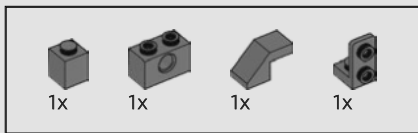

38

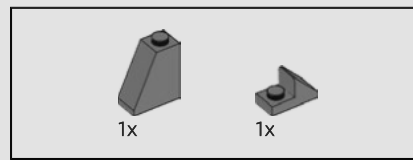
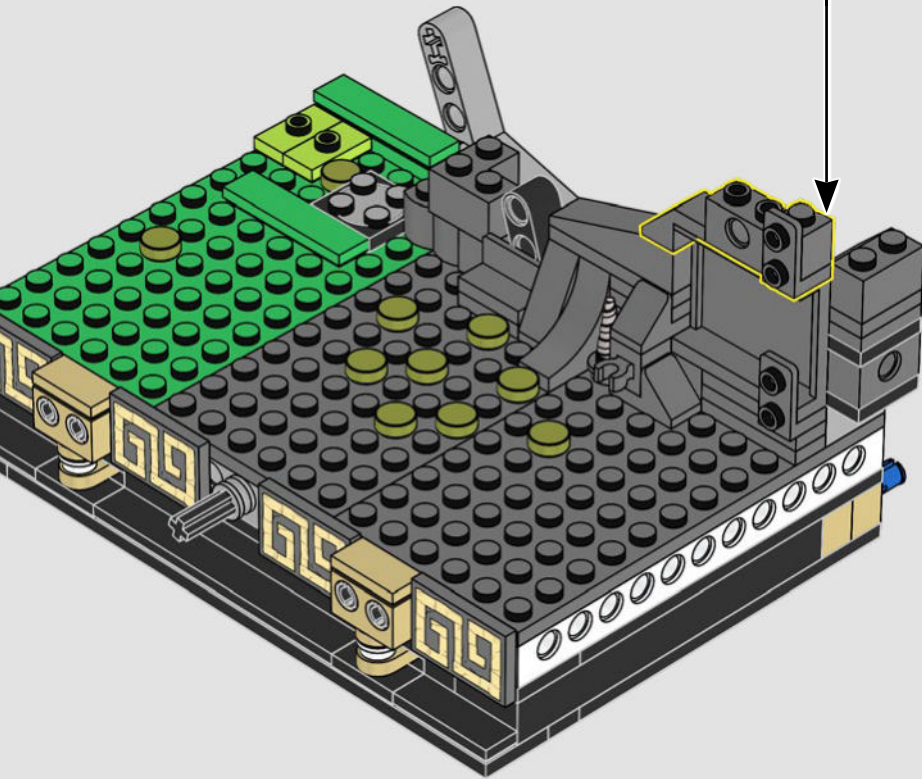
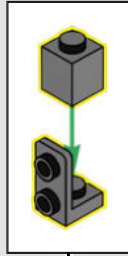

39

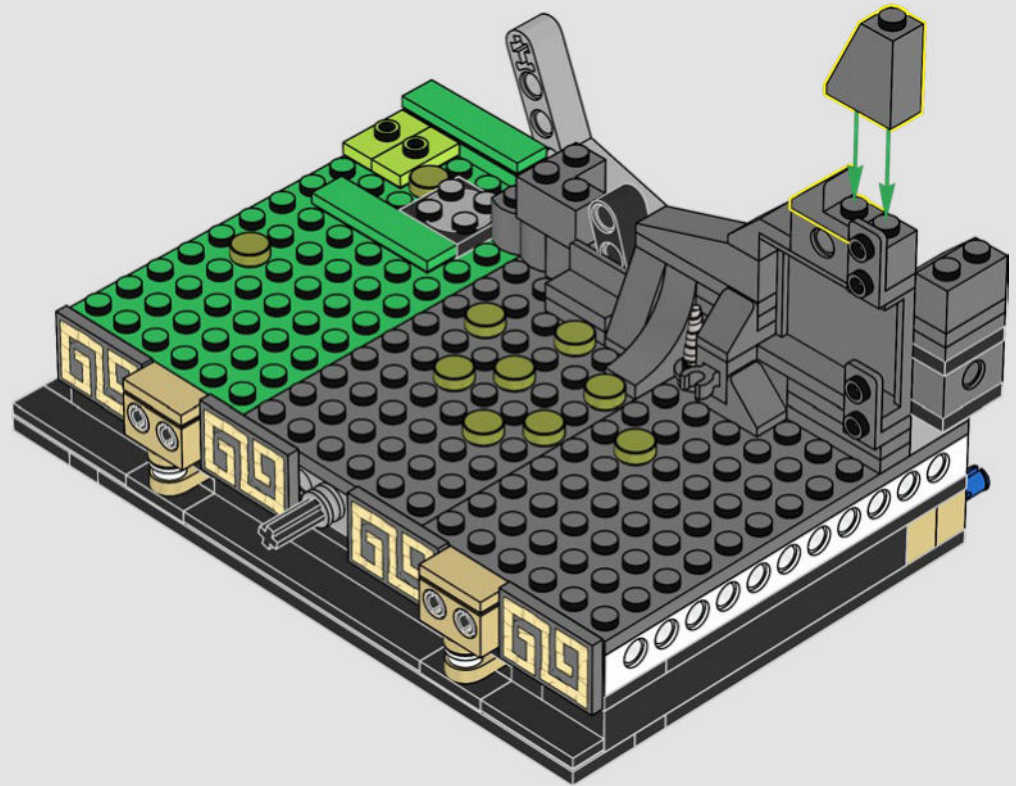

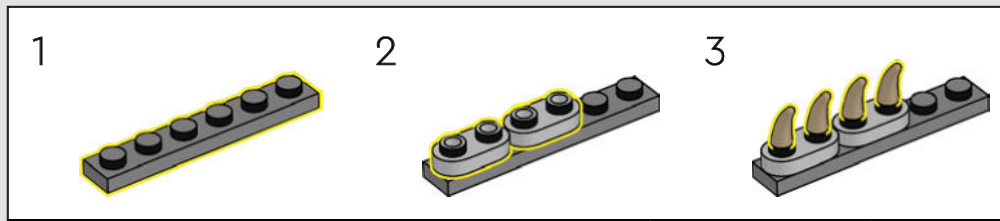
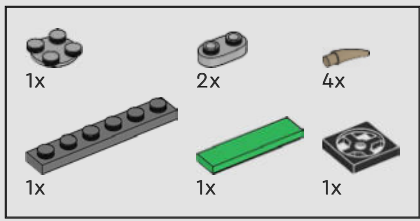

40

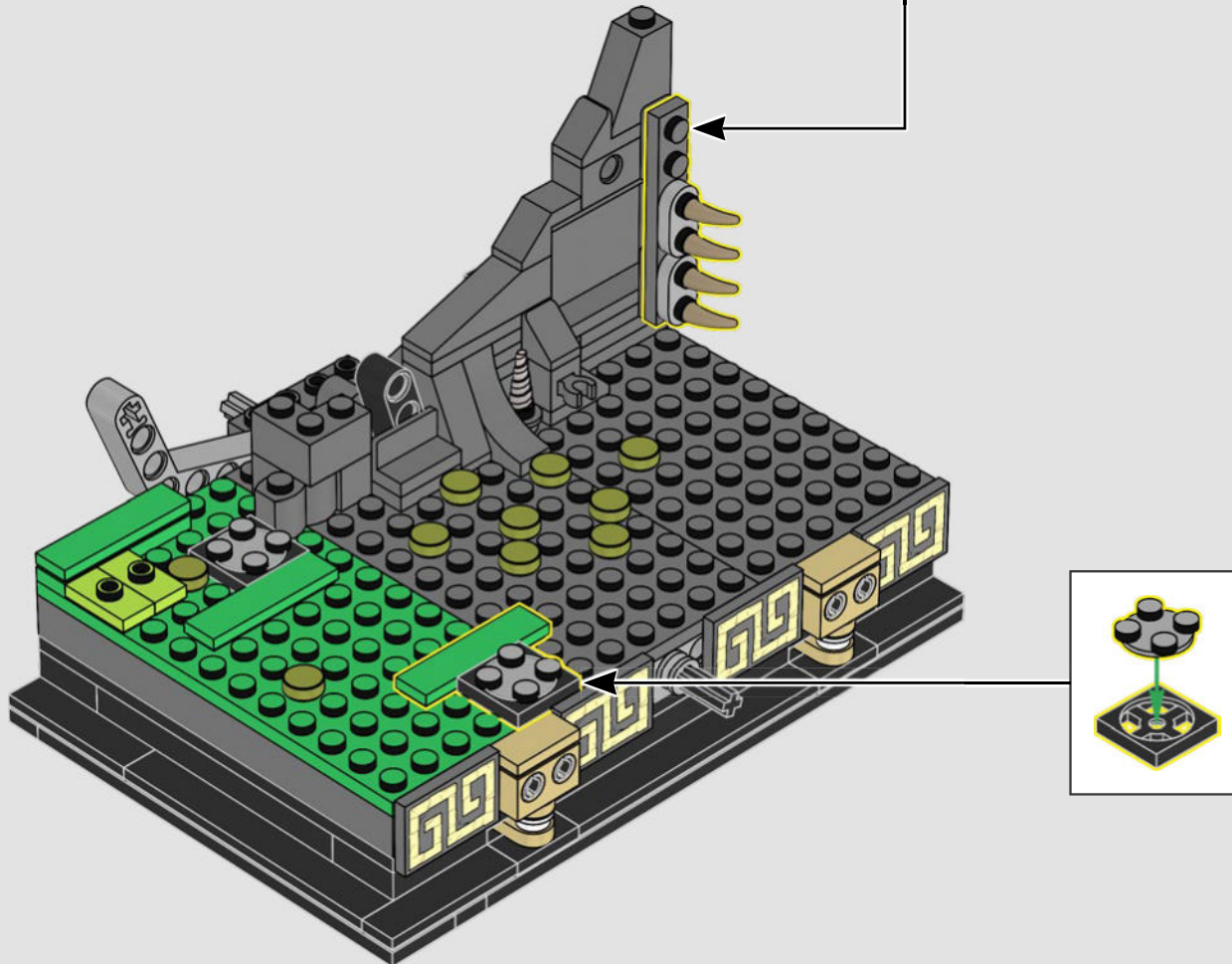

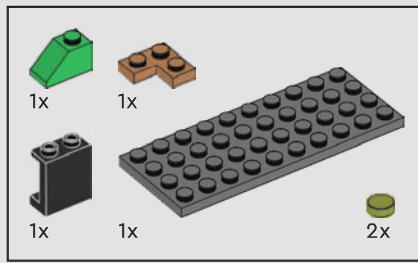

41

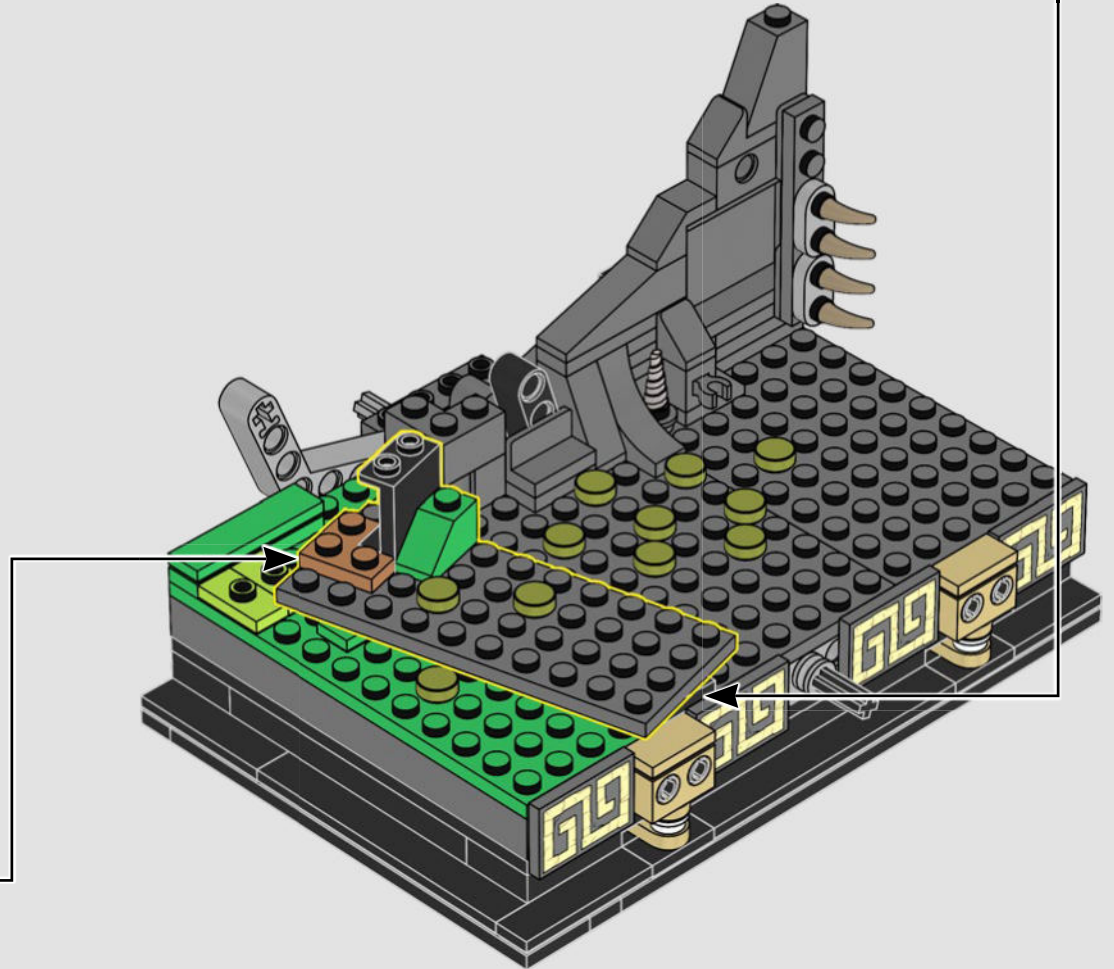
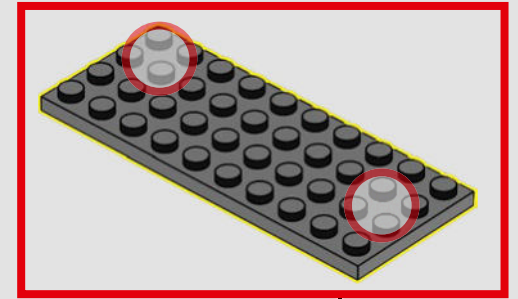
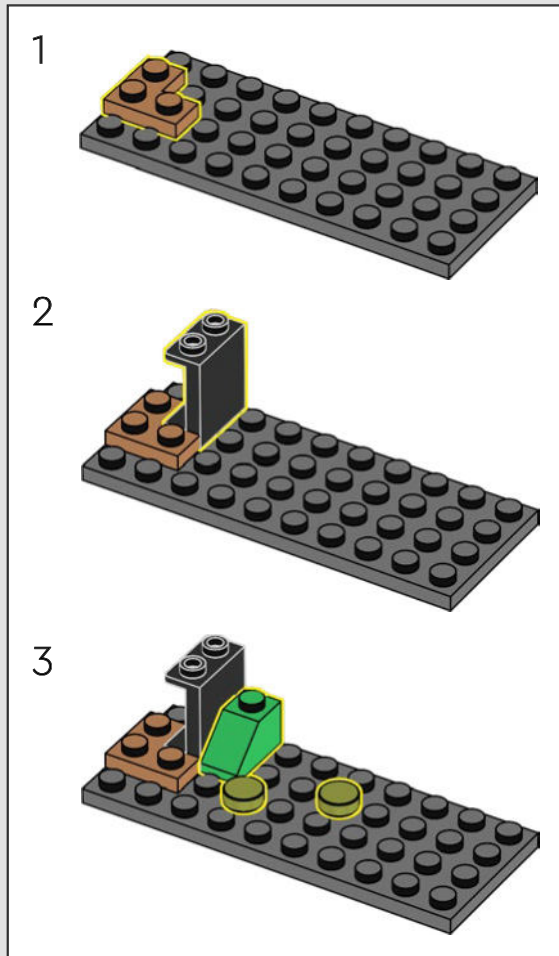

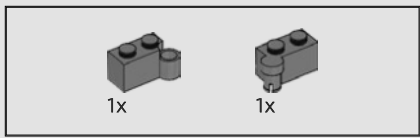

42

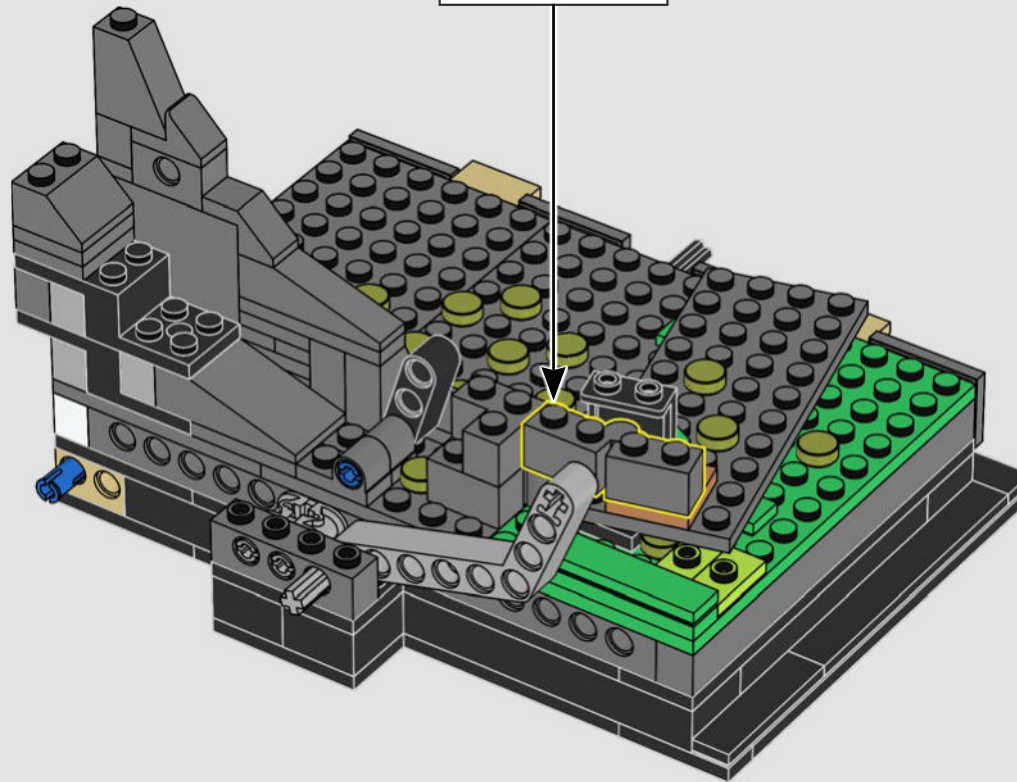
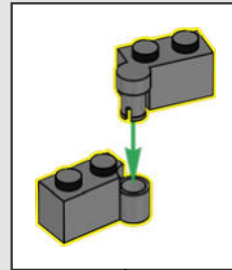

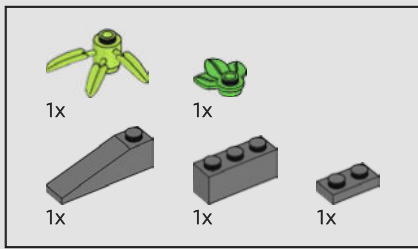

43

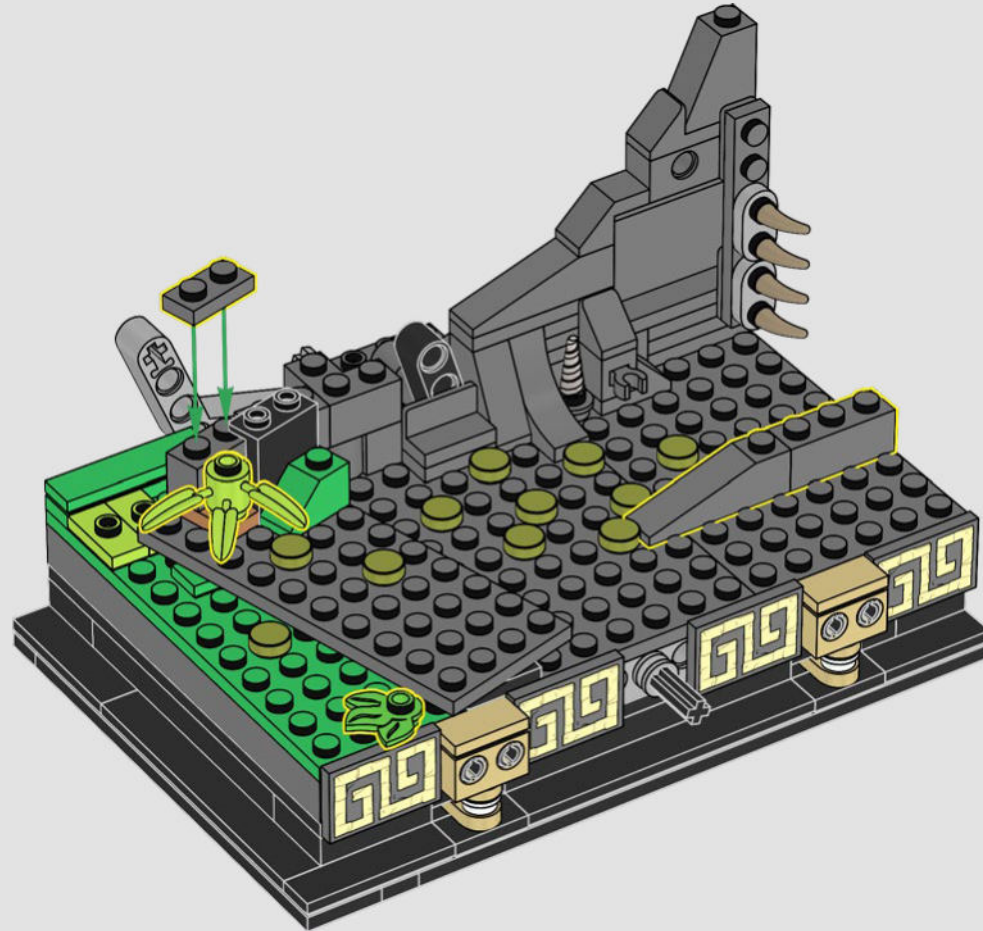

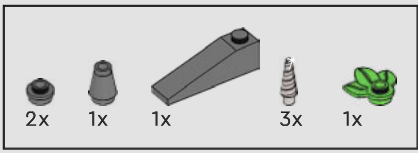

44

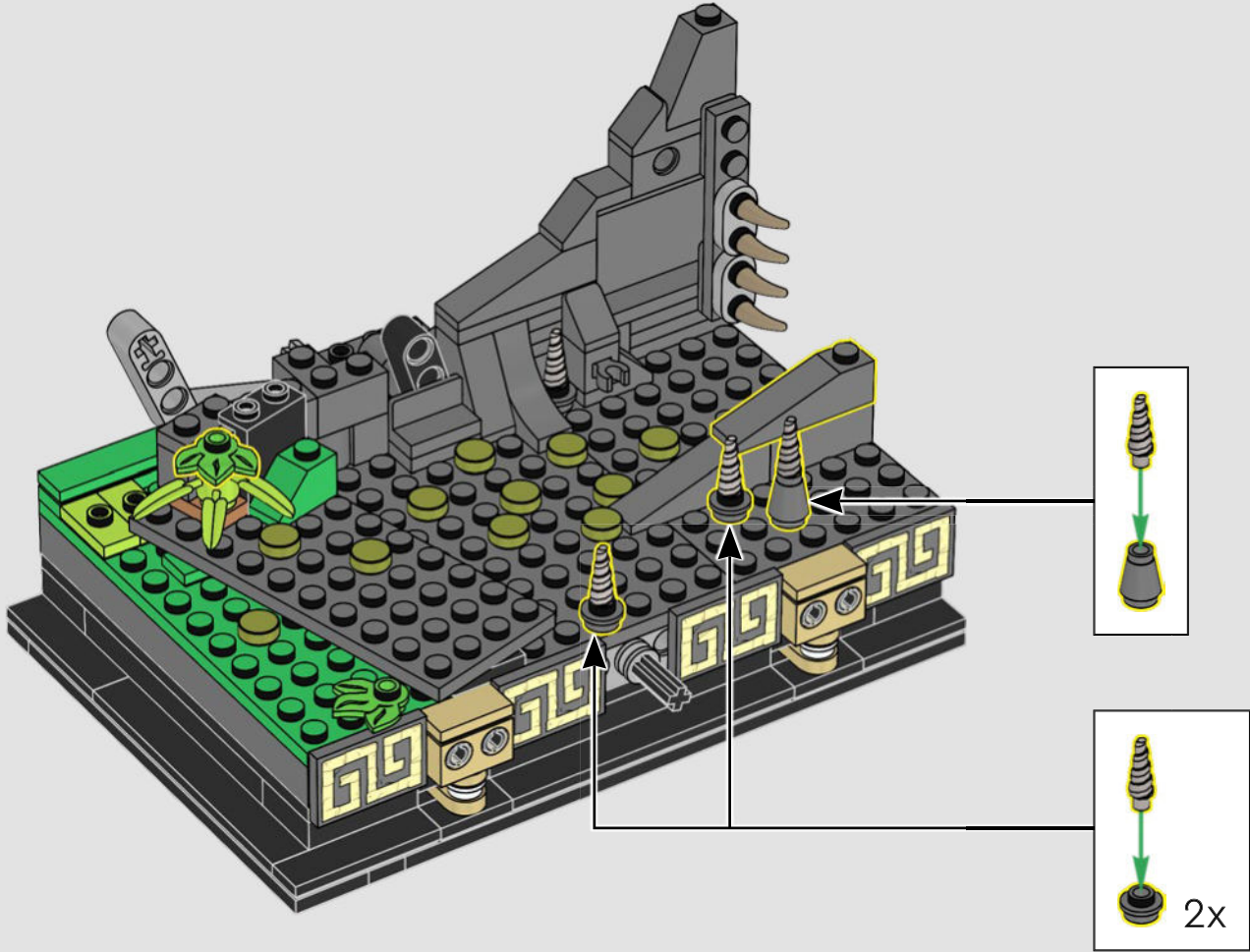



45

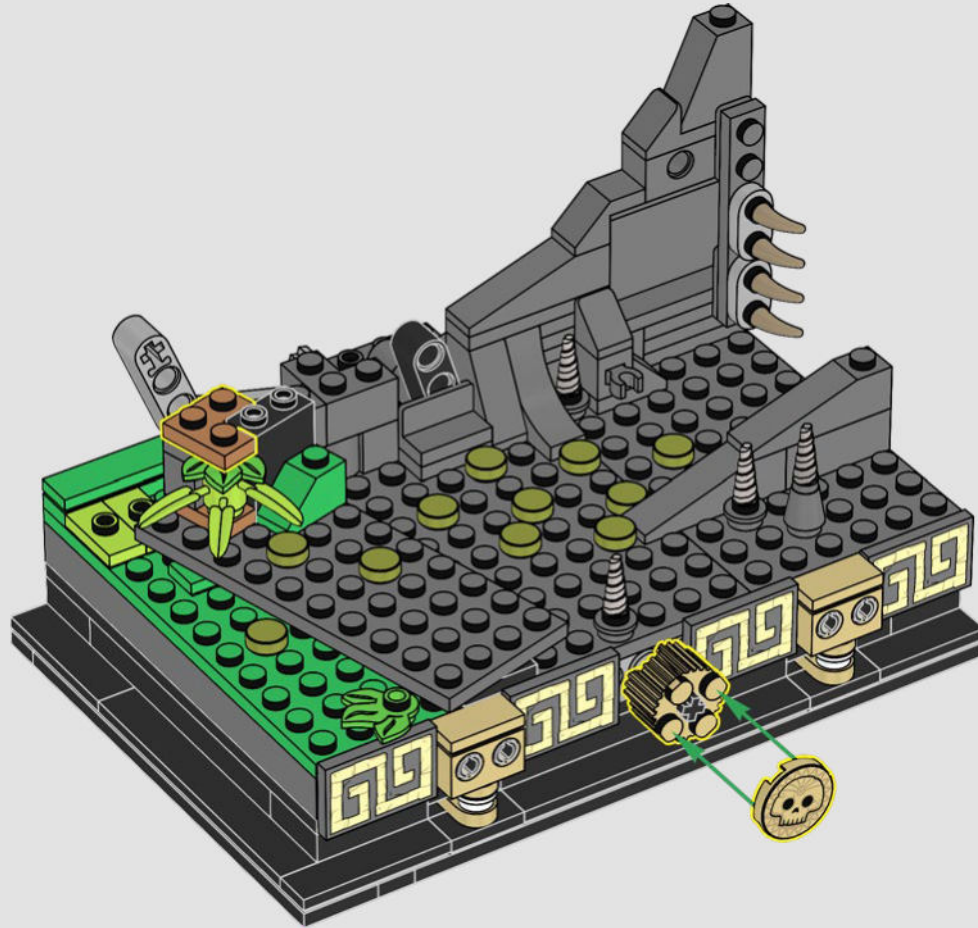

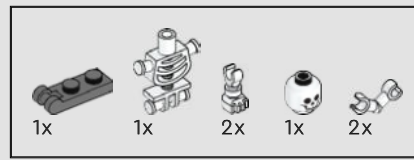

46

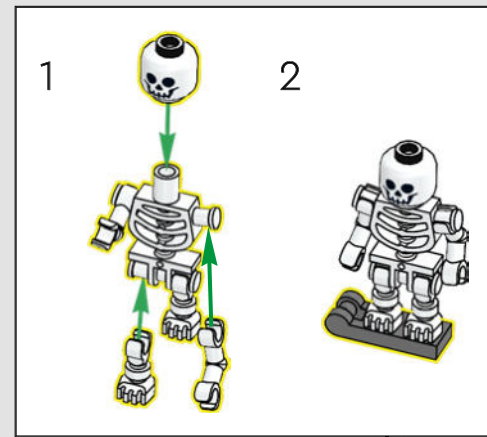

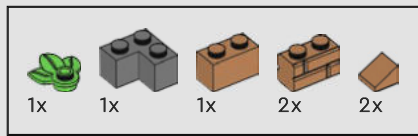

47

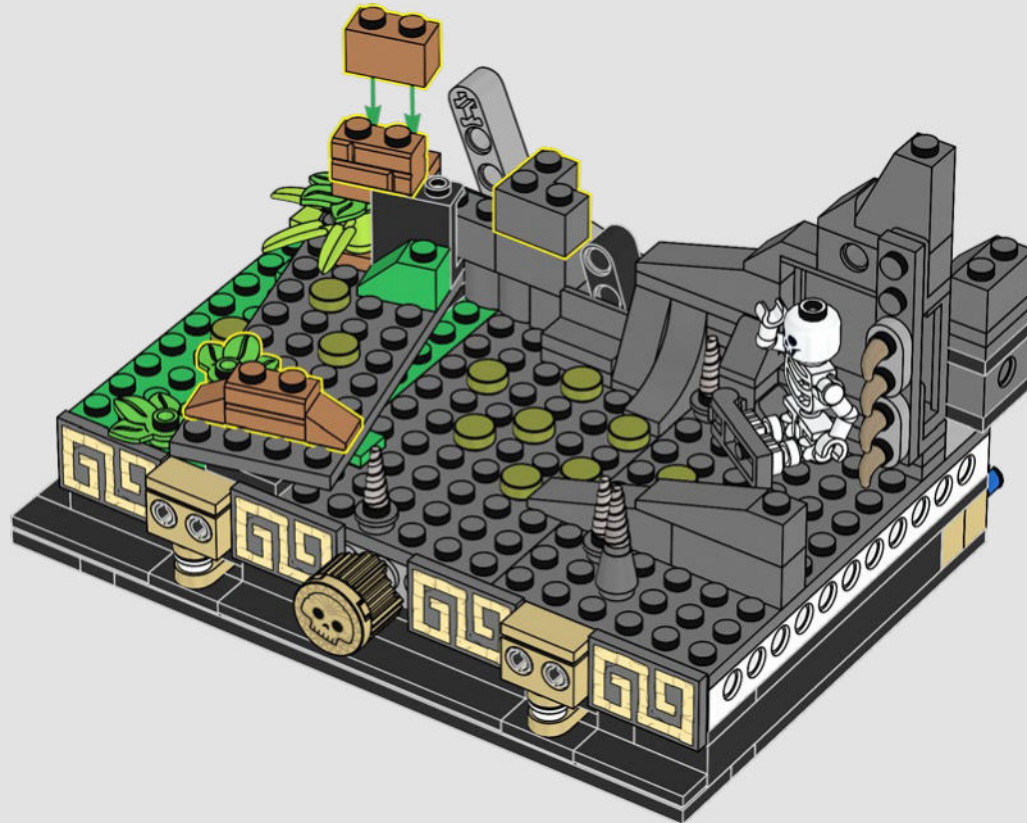

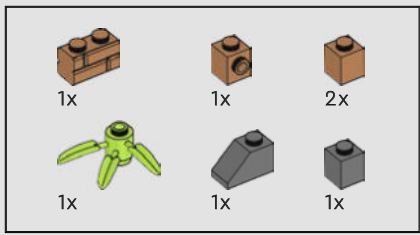

48

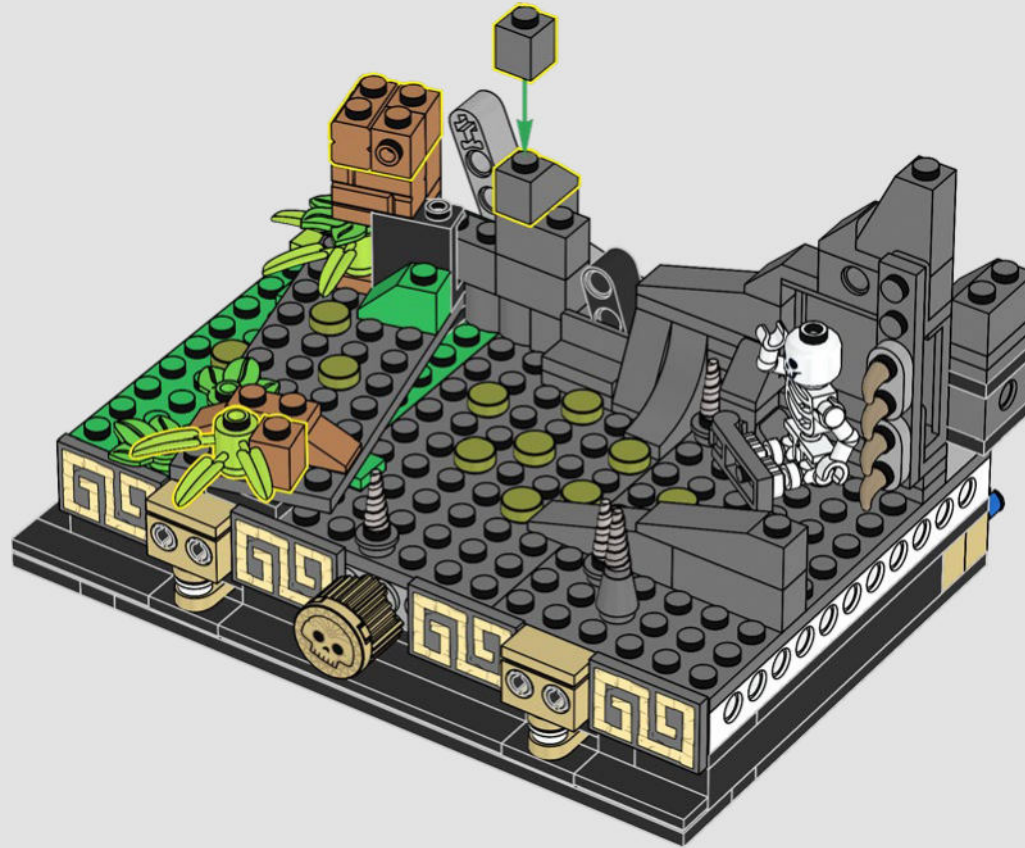

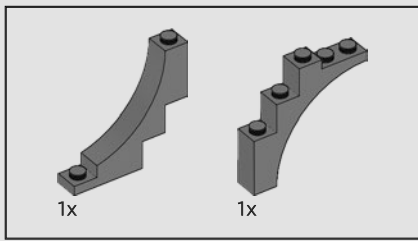

49

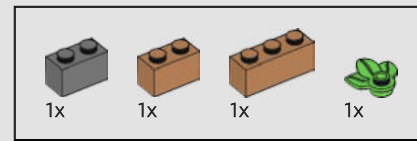
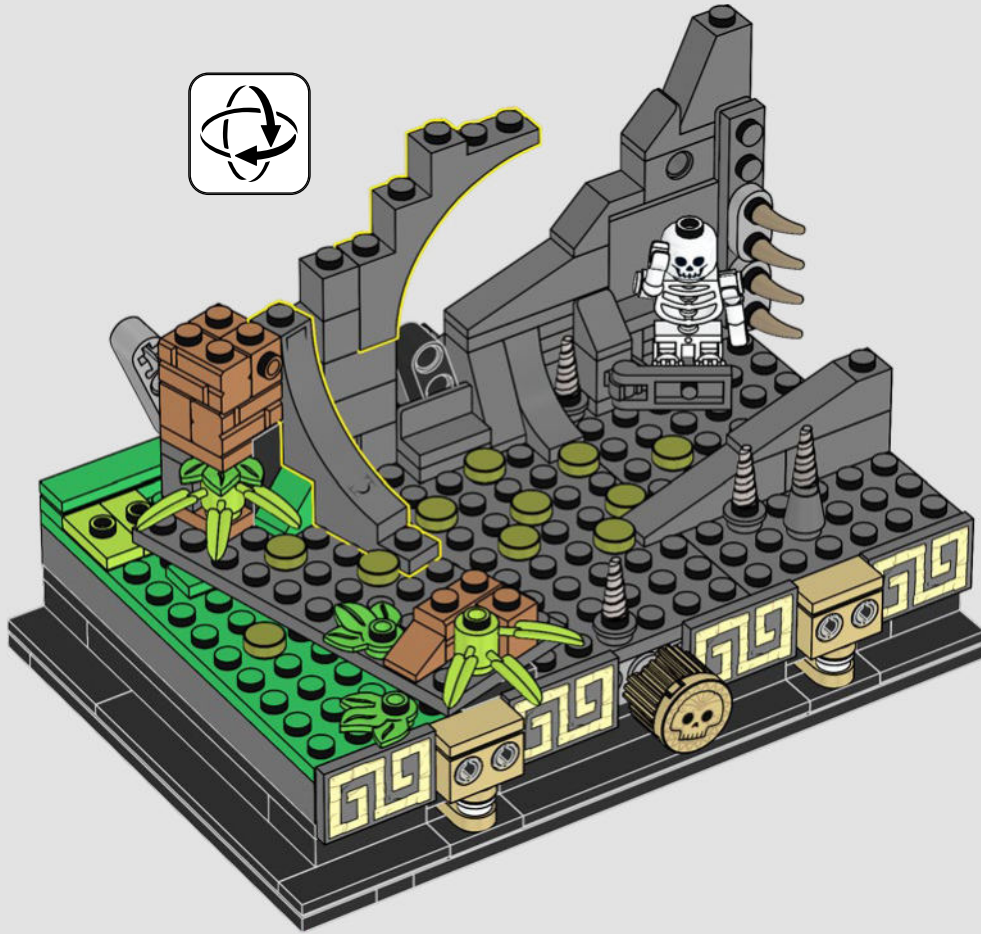

50

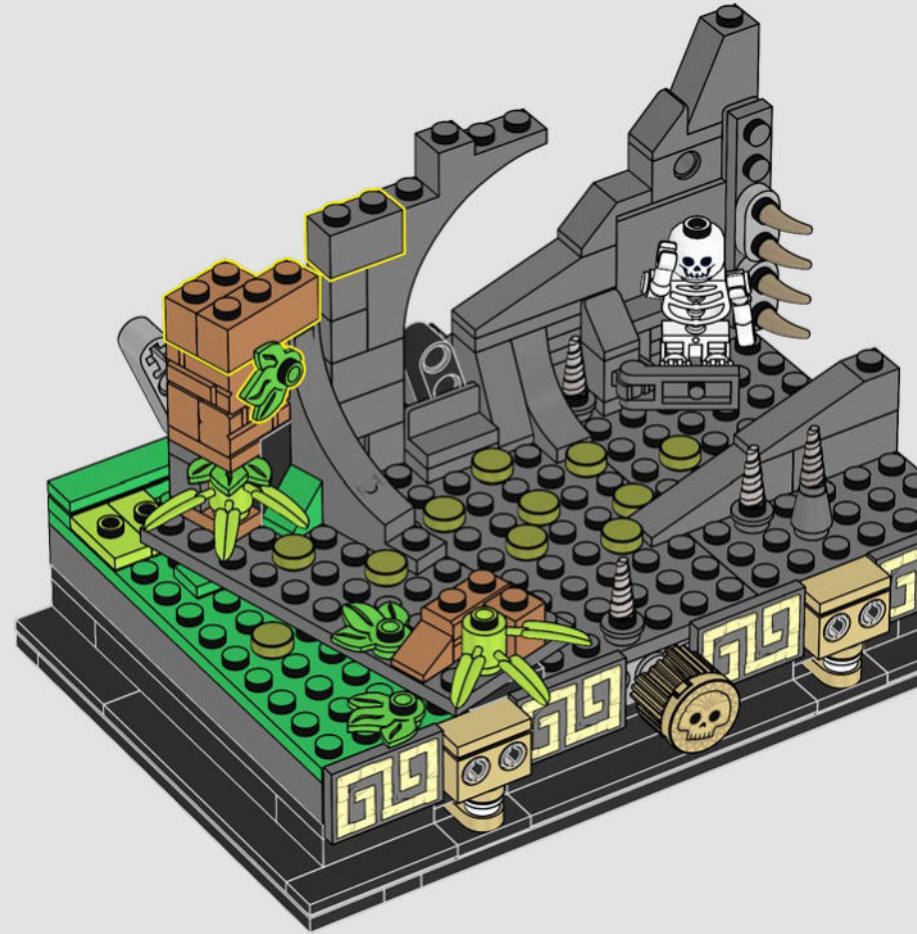

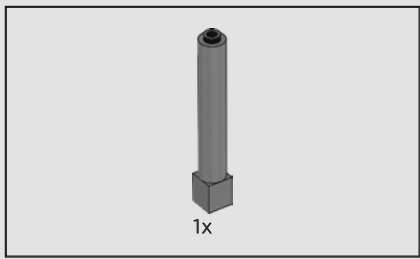

51

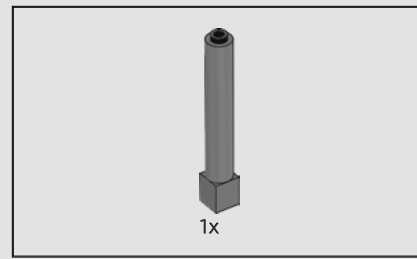
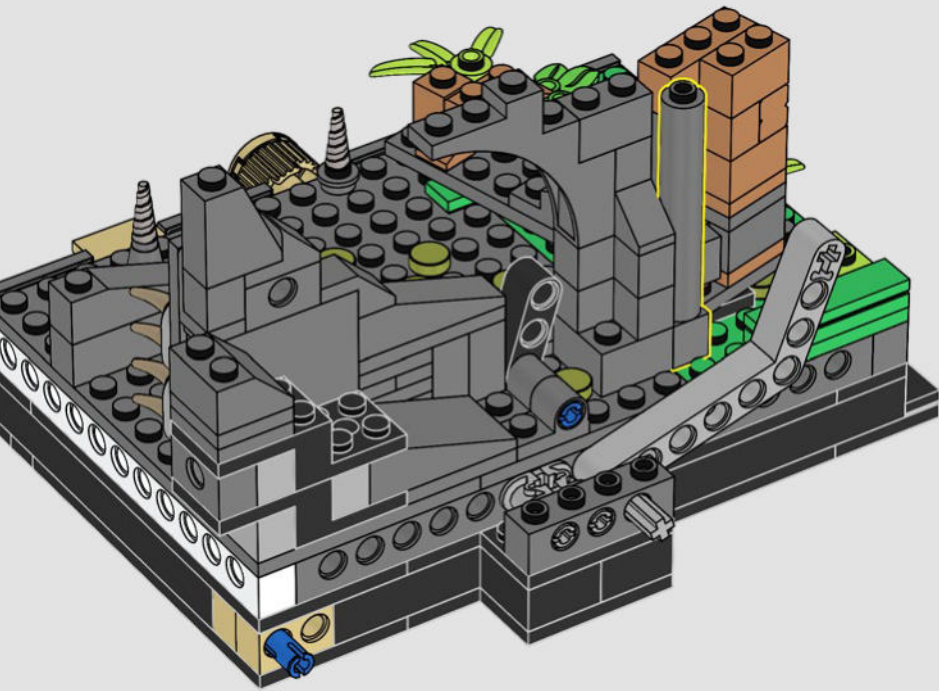

52

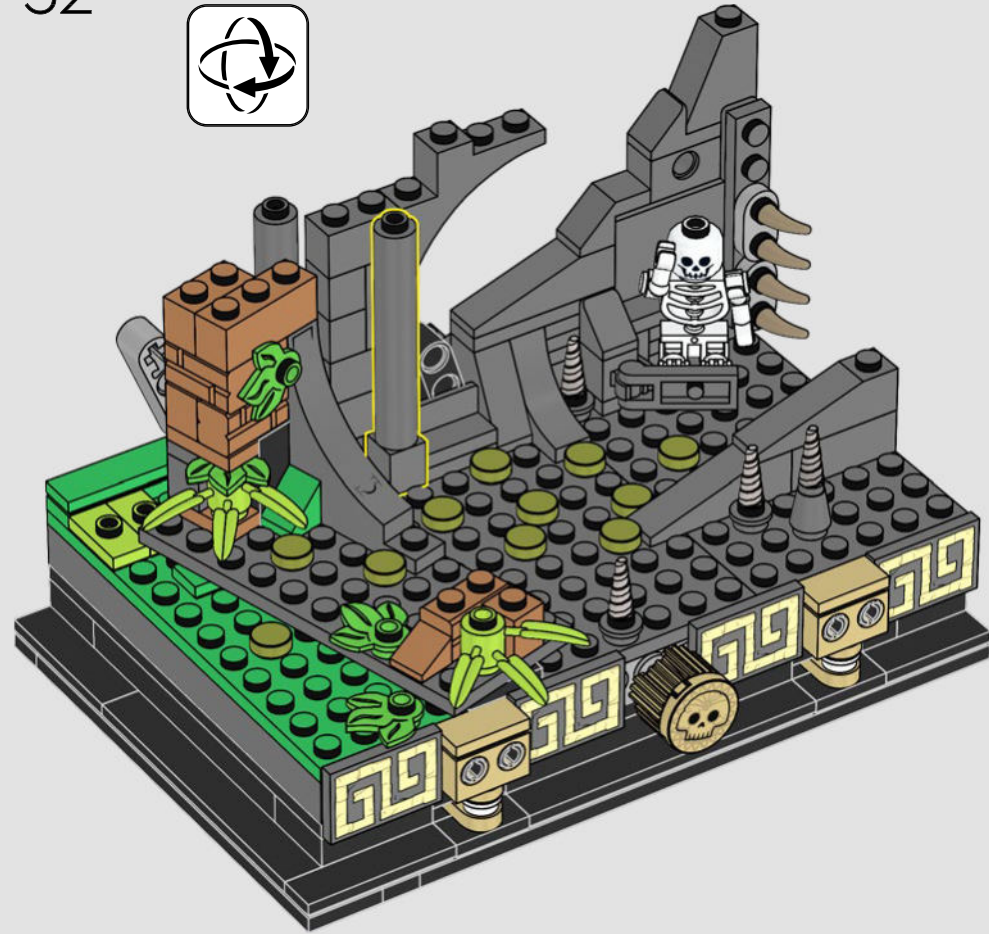
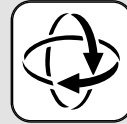



2x

53

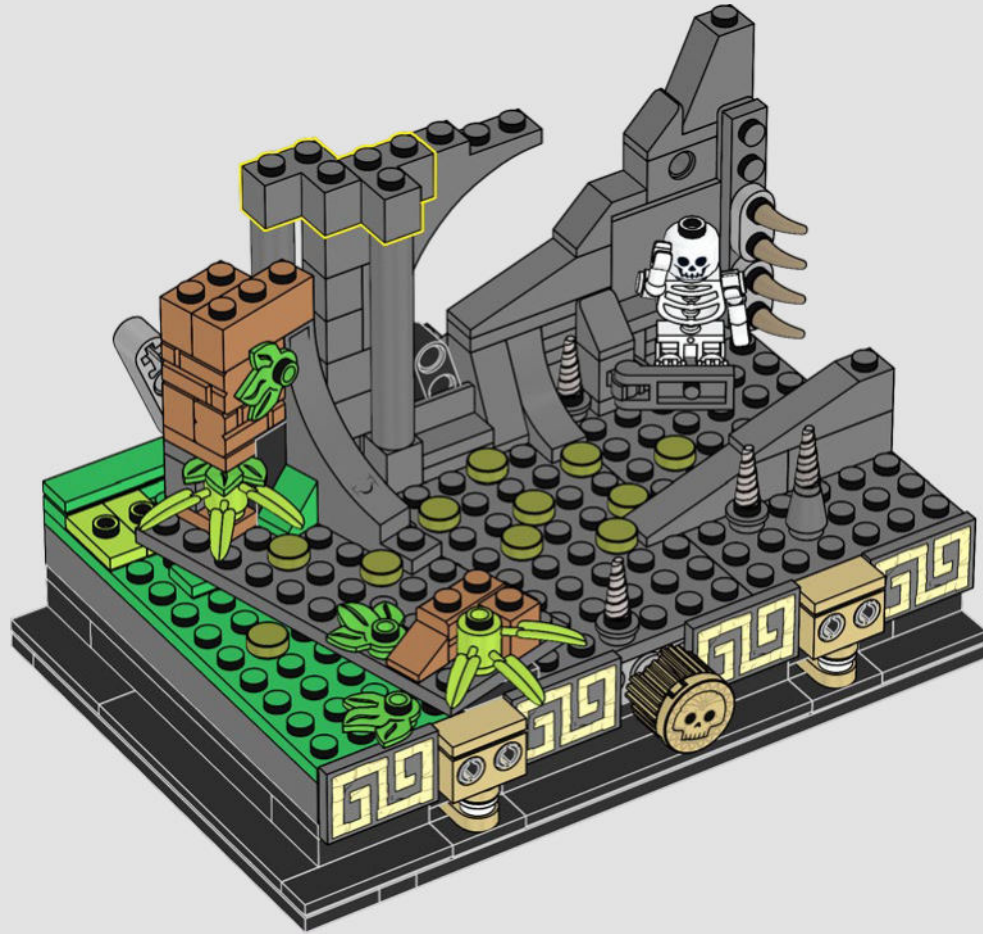

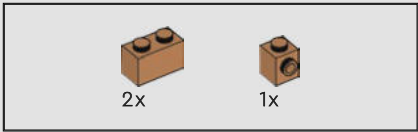

54

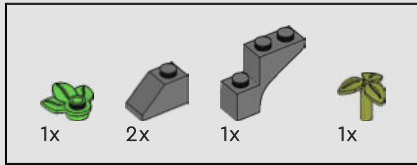
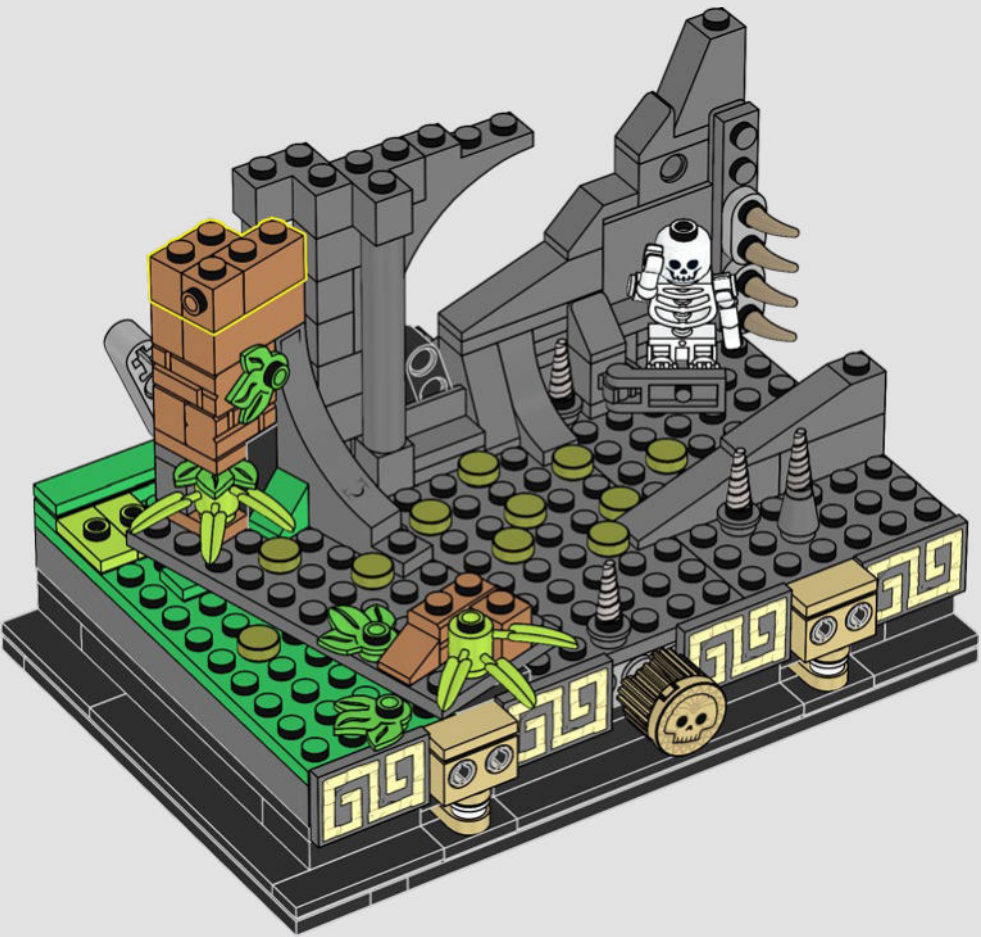

55

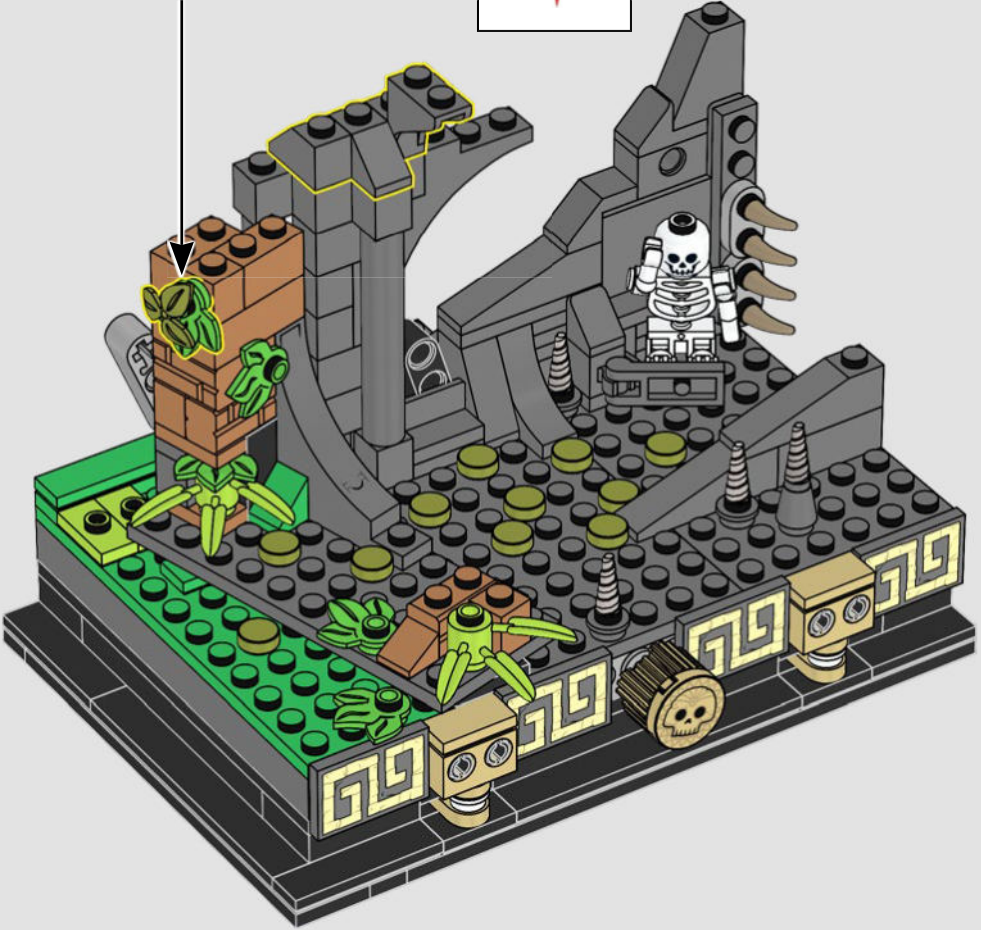
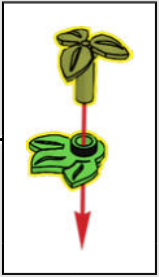

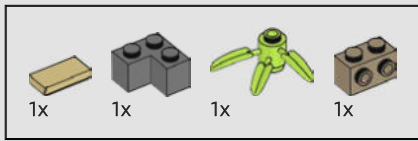

56

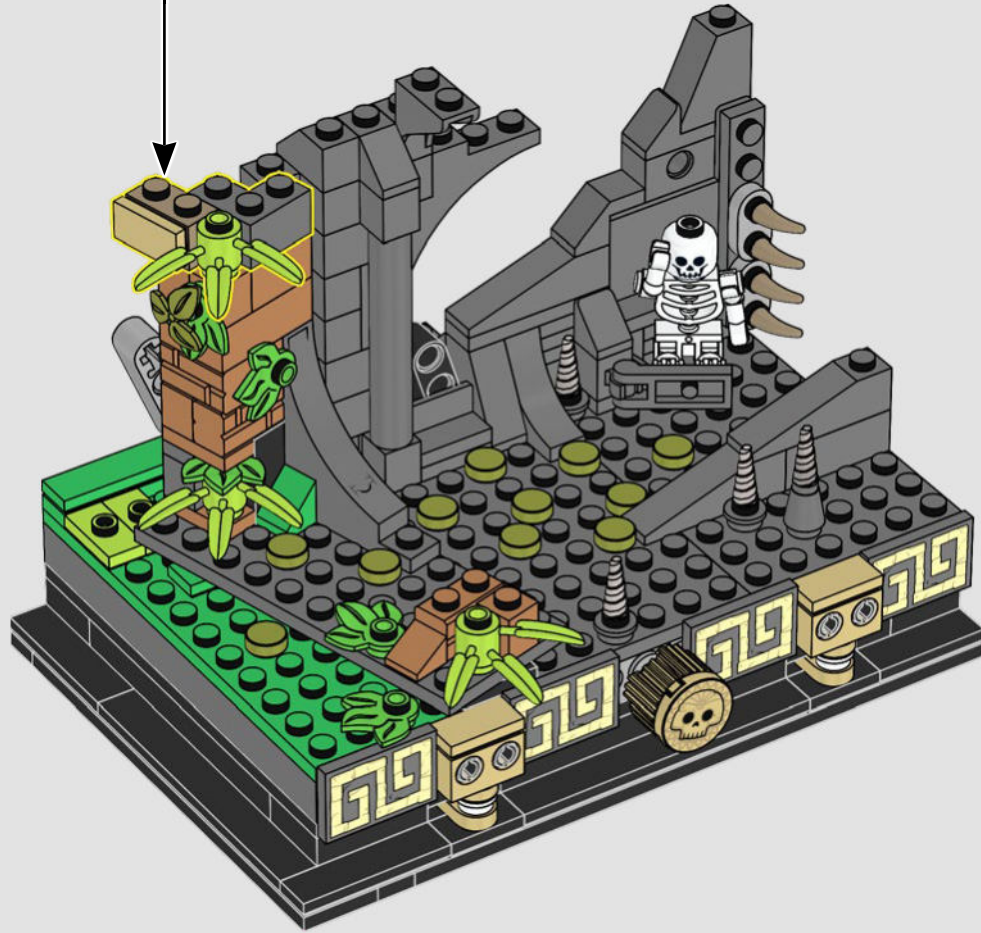
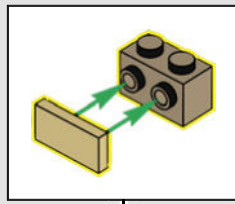

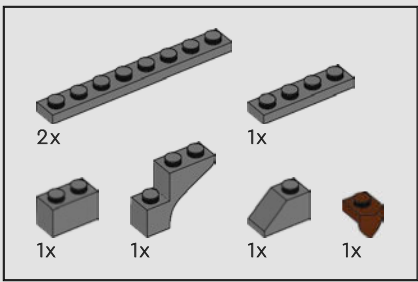

57

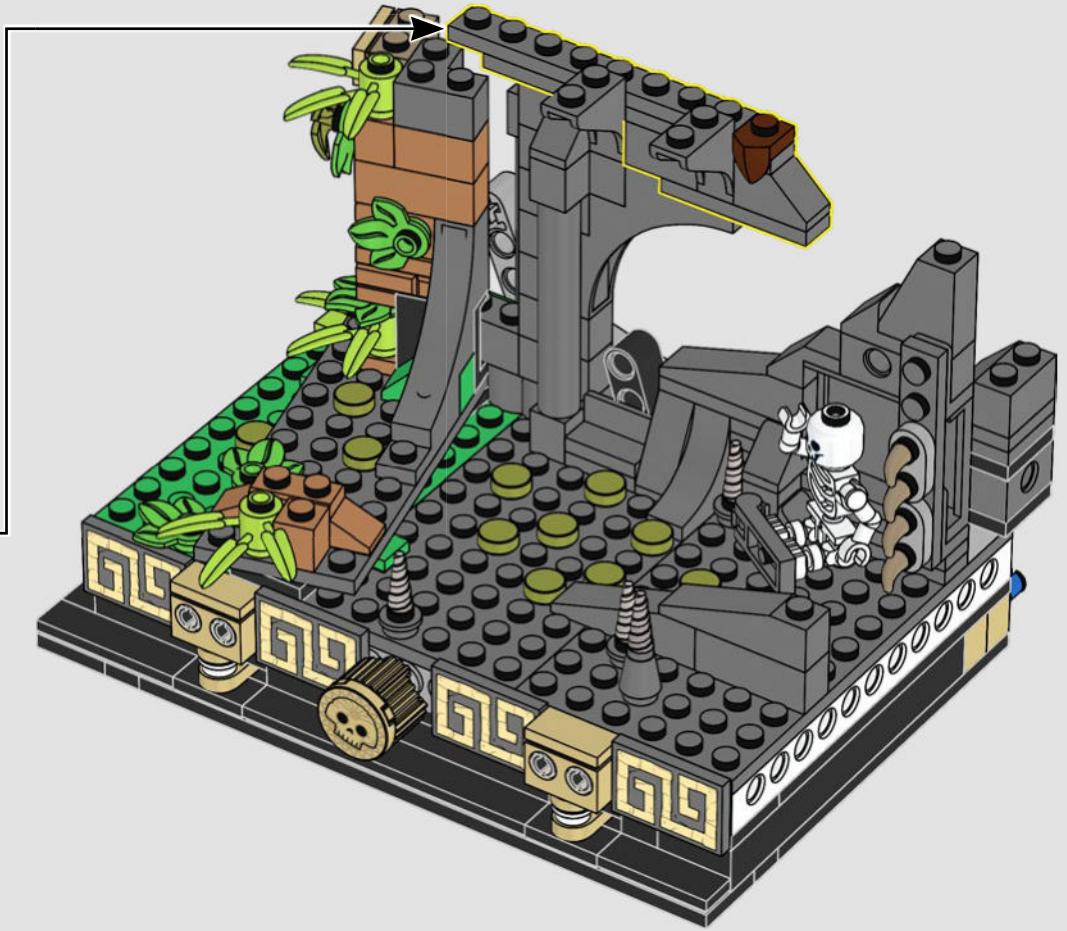
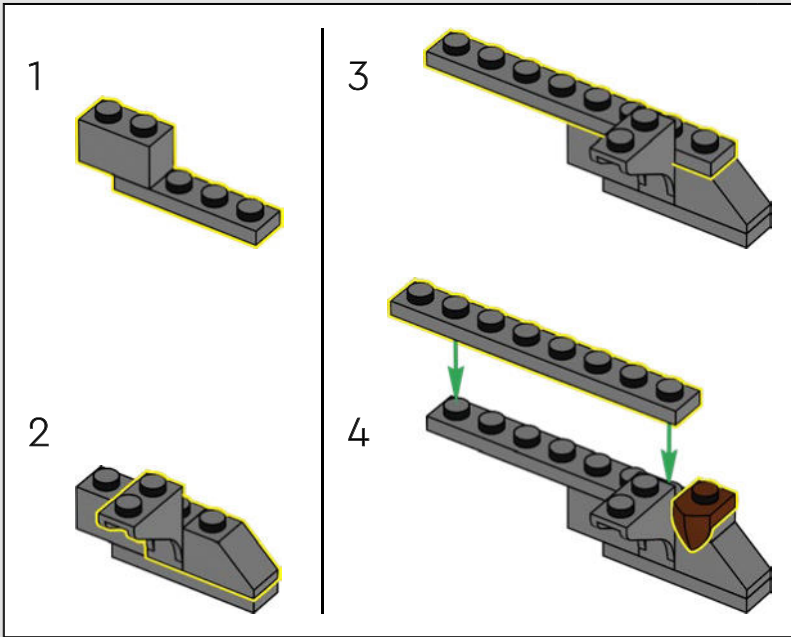

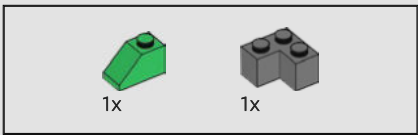

58



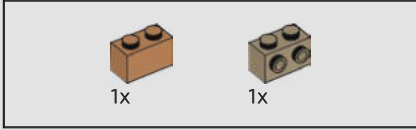
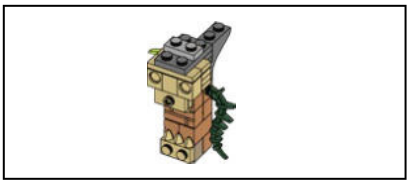

59

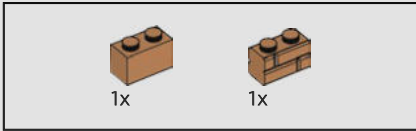
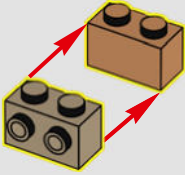

60

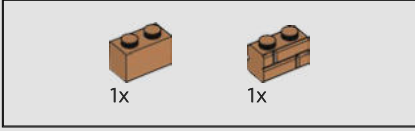
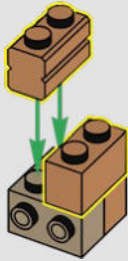

61

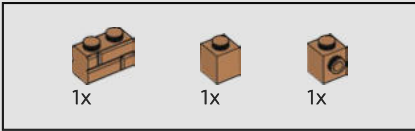
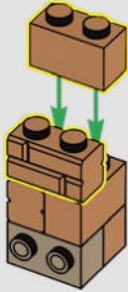

62

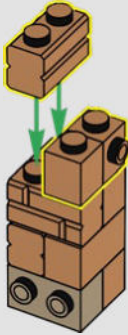



63

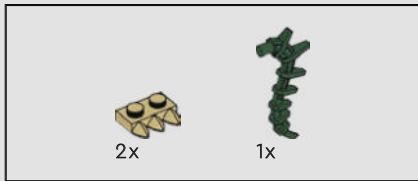
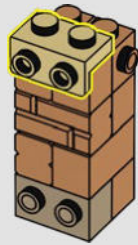

64

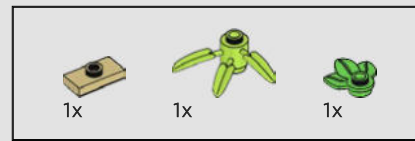
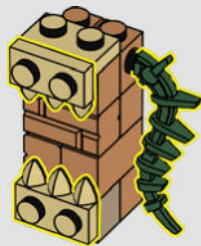

65

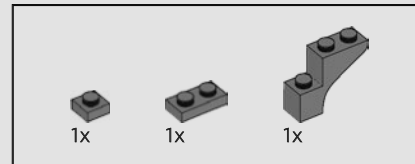
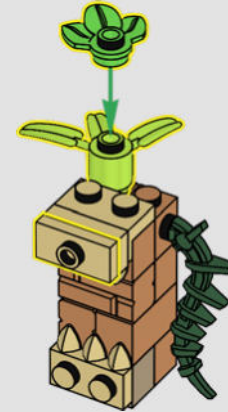

66

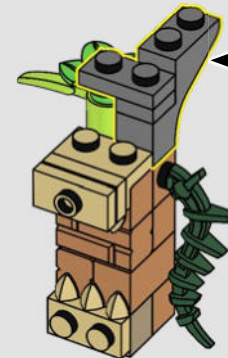
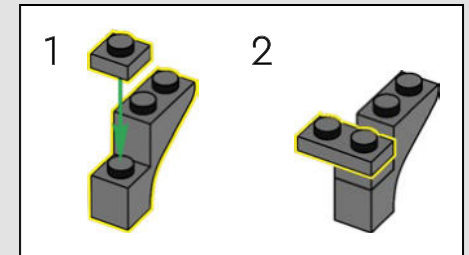

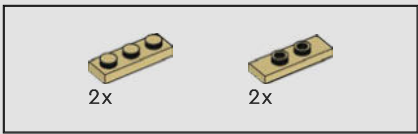

67

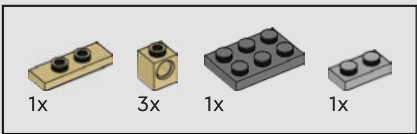
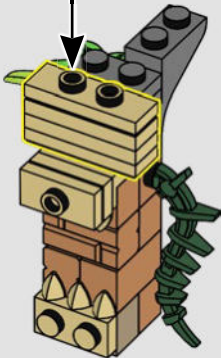
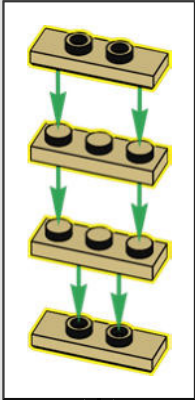

68

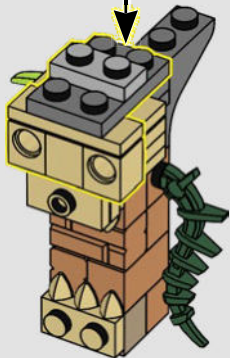
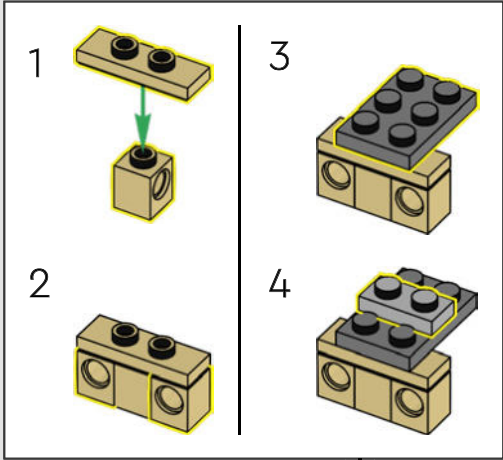

69

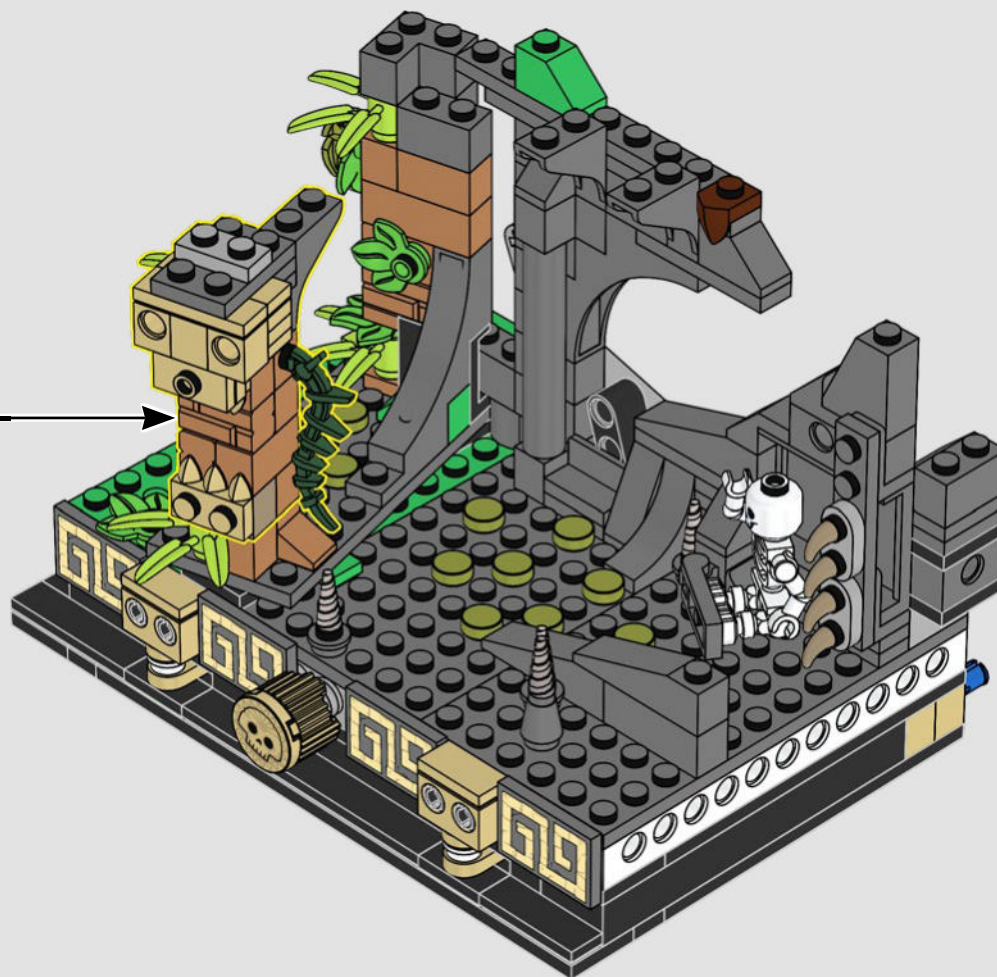

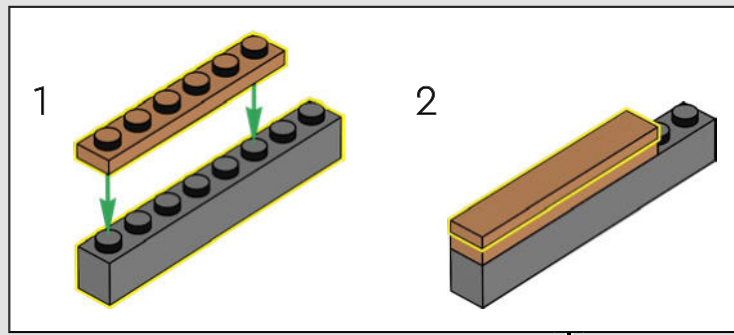
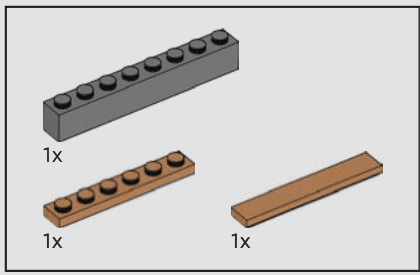

70

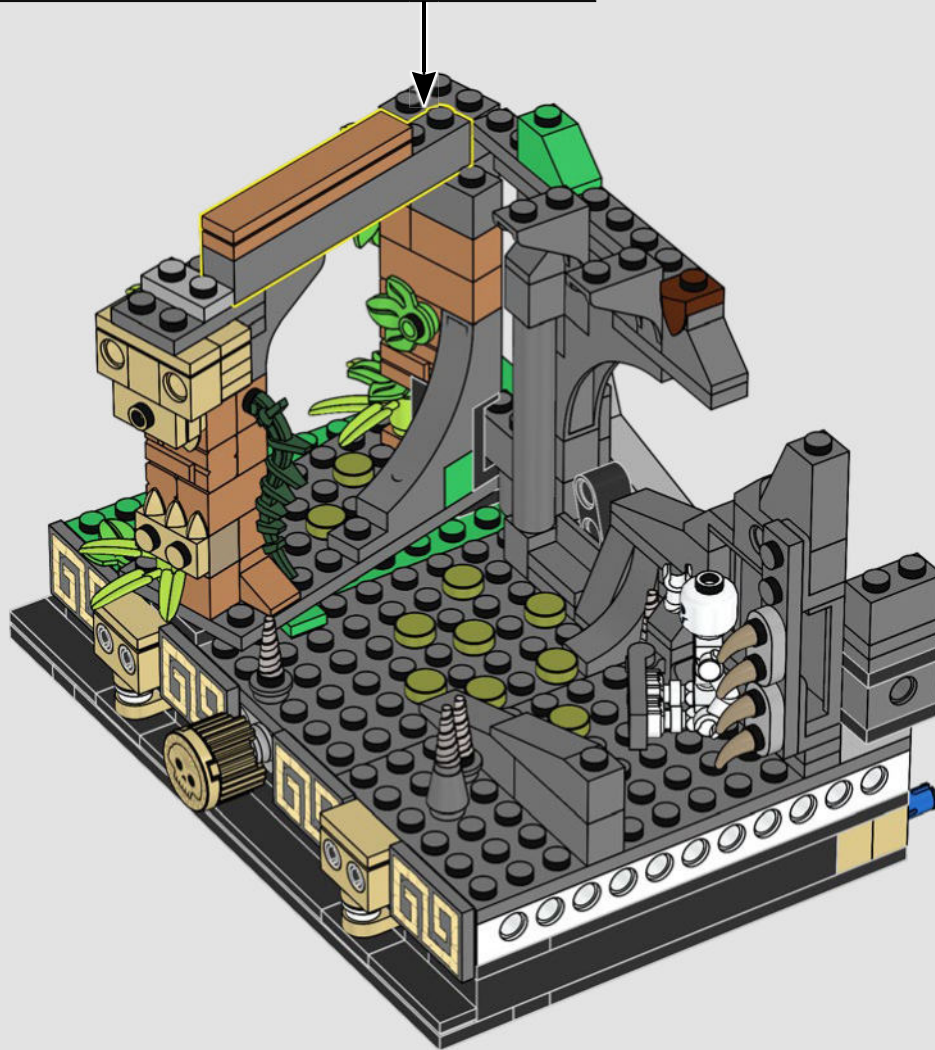

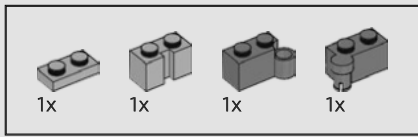

71

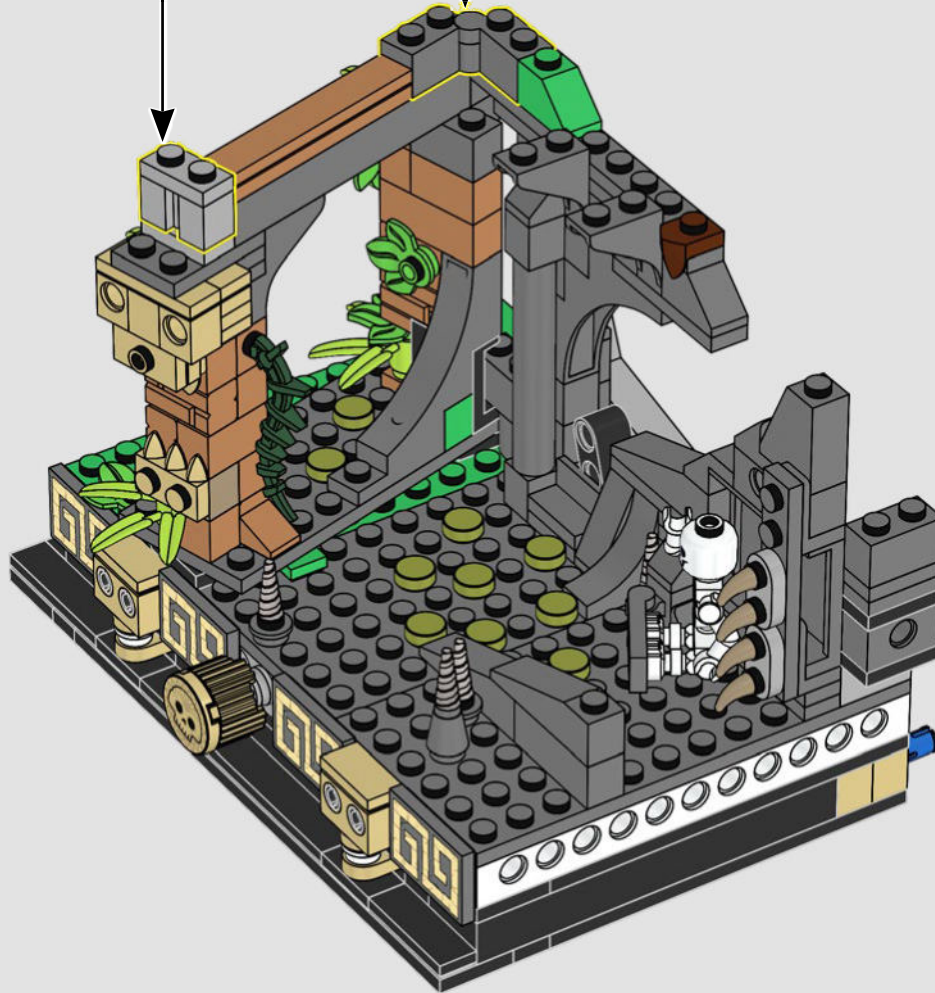
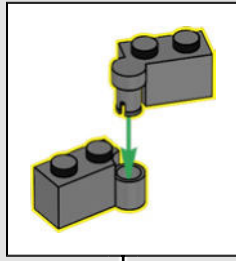
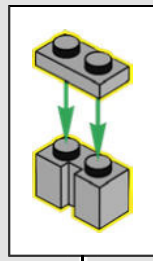

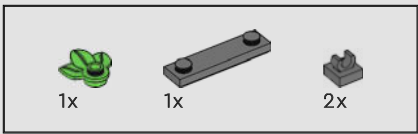

72

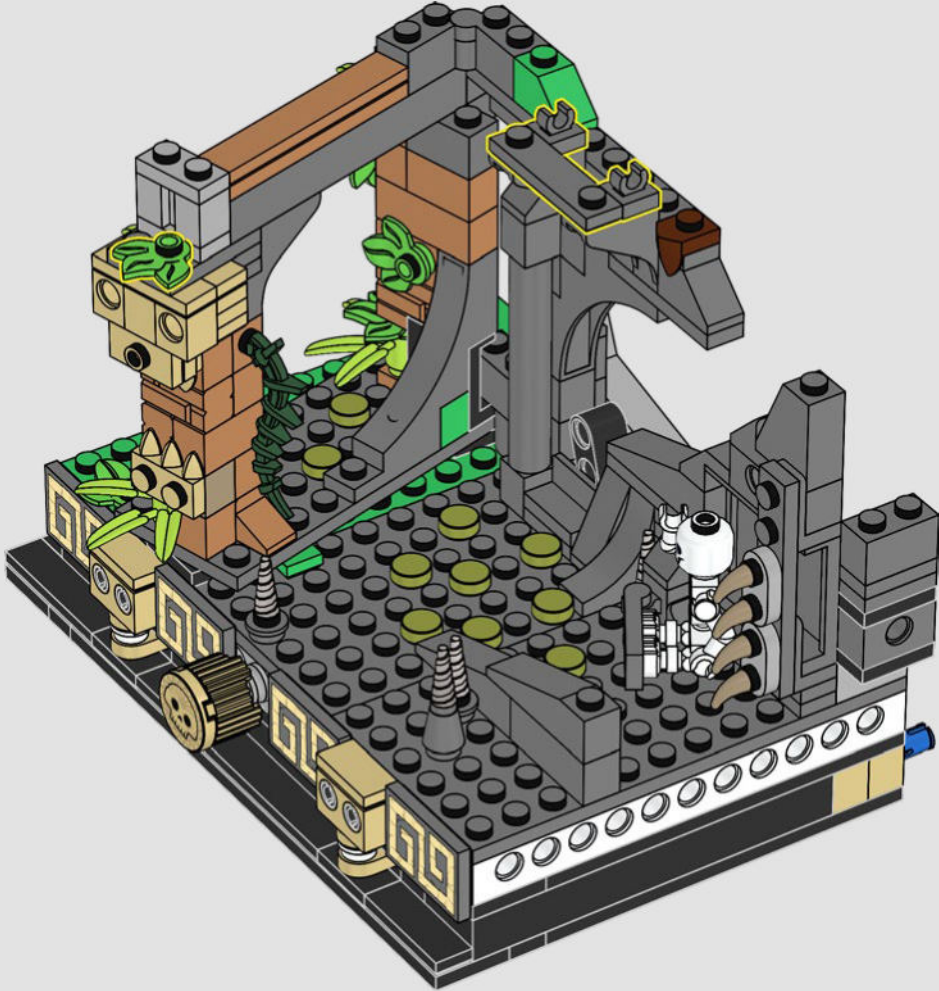

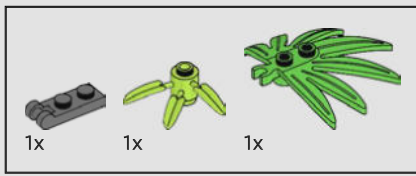

73

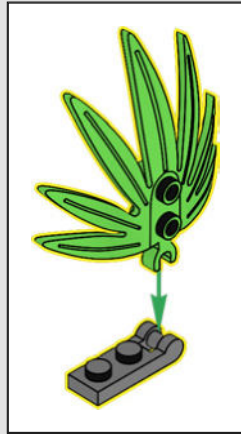

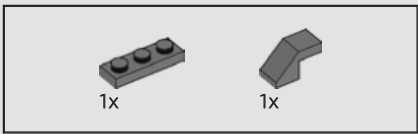

74

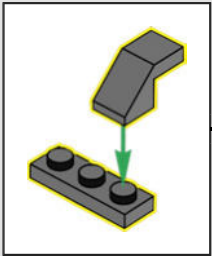

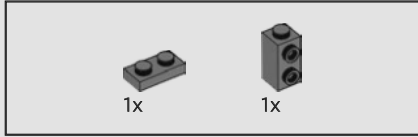
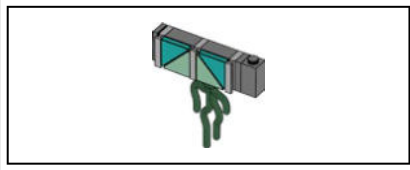

75

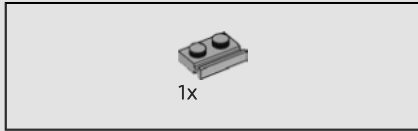
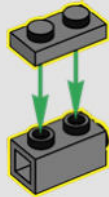

76



77

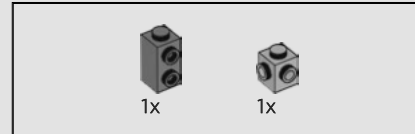
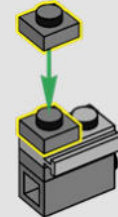

78

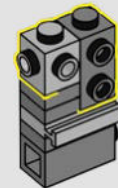



79

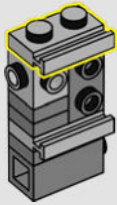

80

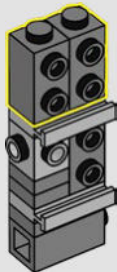

81

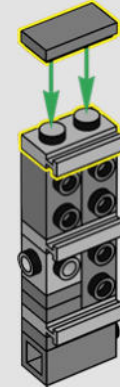

82

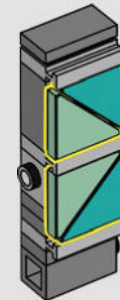

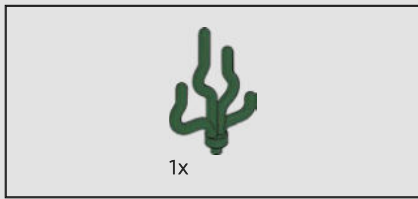

83

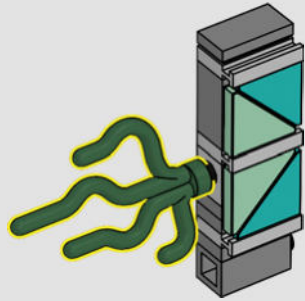

84





85





86

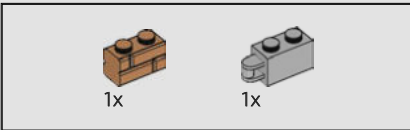

87

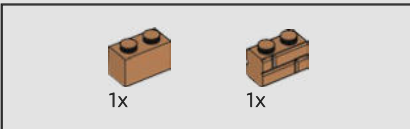
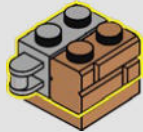

88

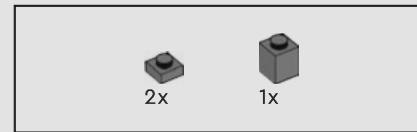
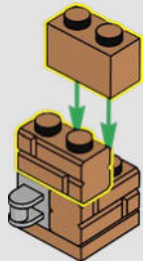

89

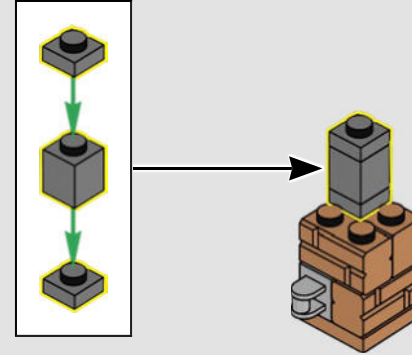

90

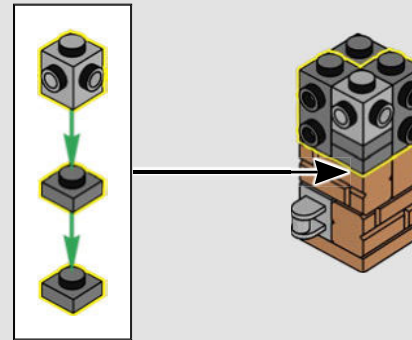



91

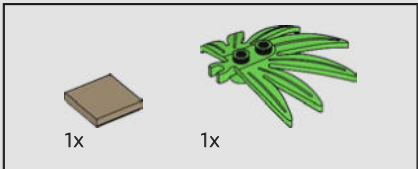
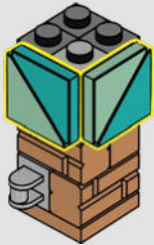

92



93



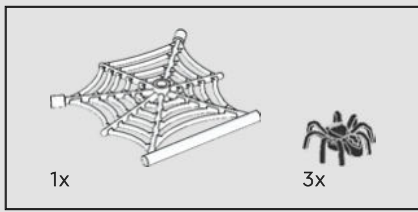

94



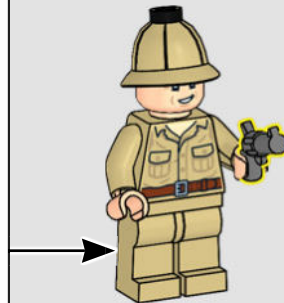
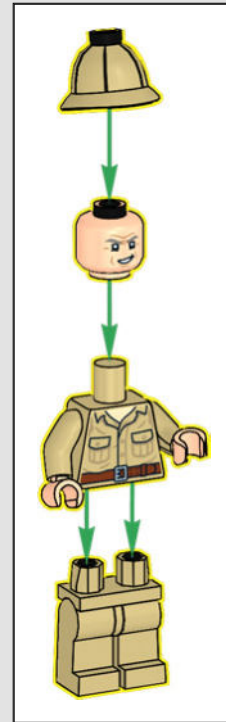



95

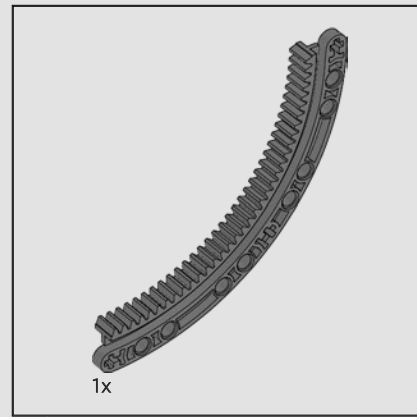
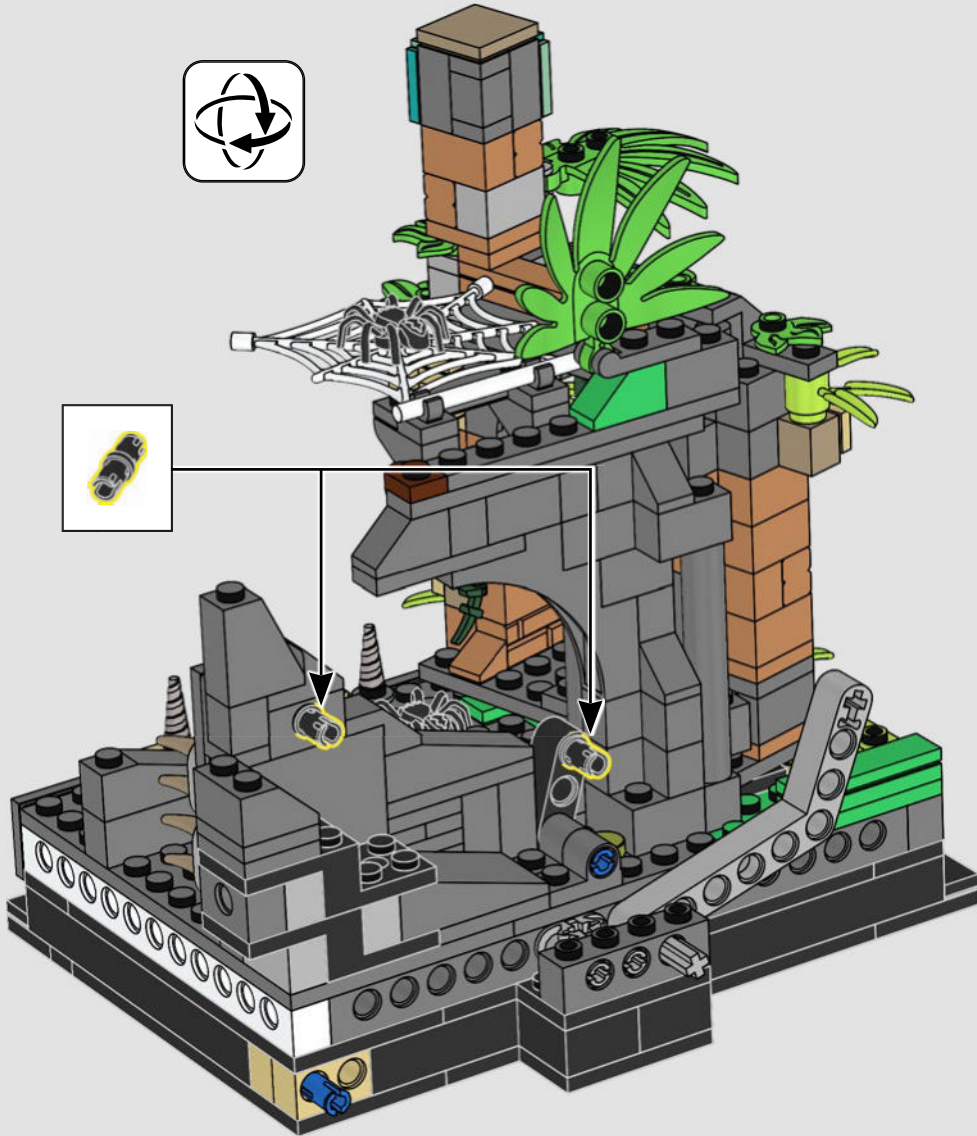

96

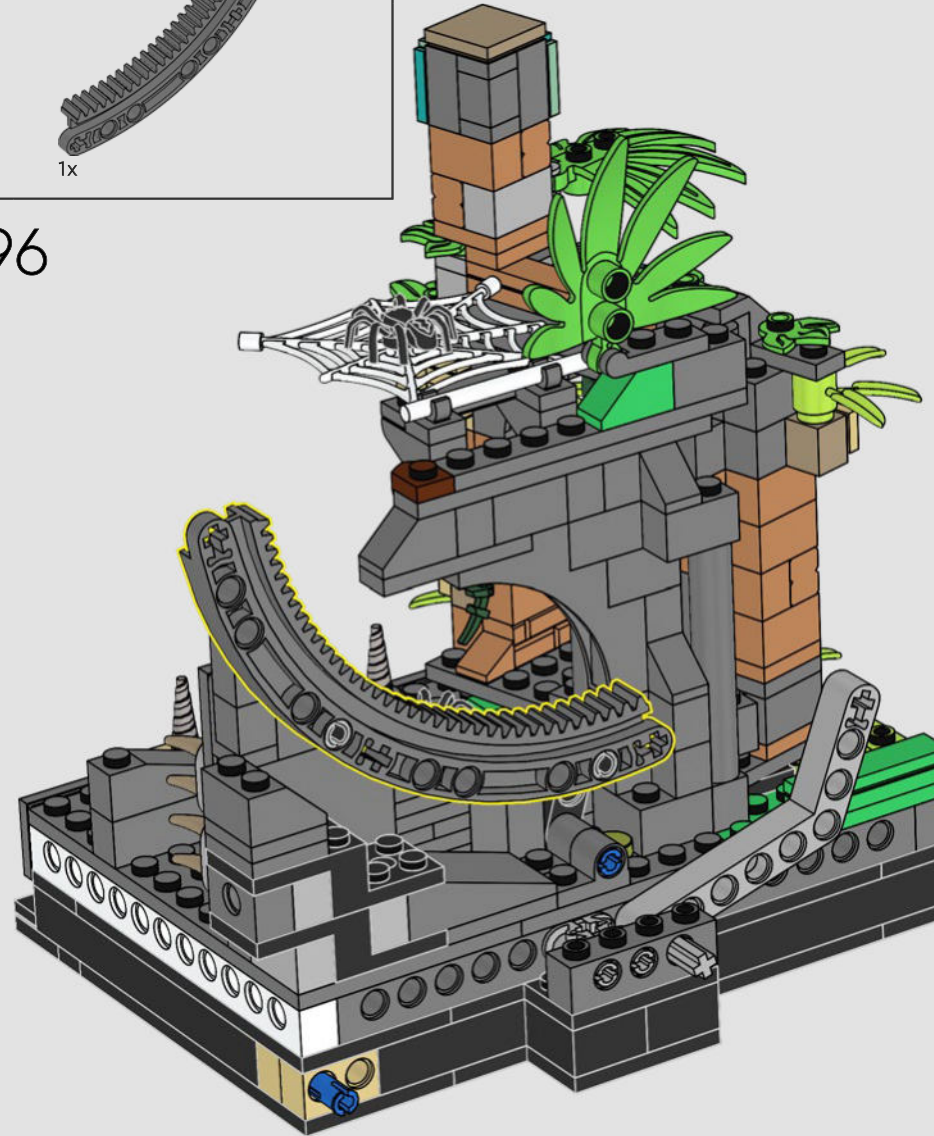



97

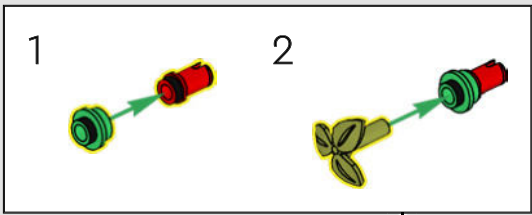

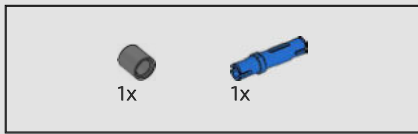

98

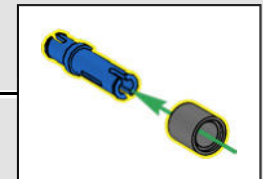
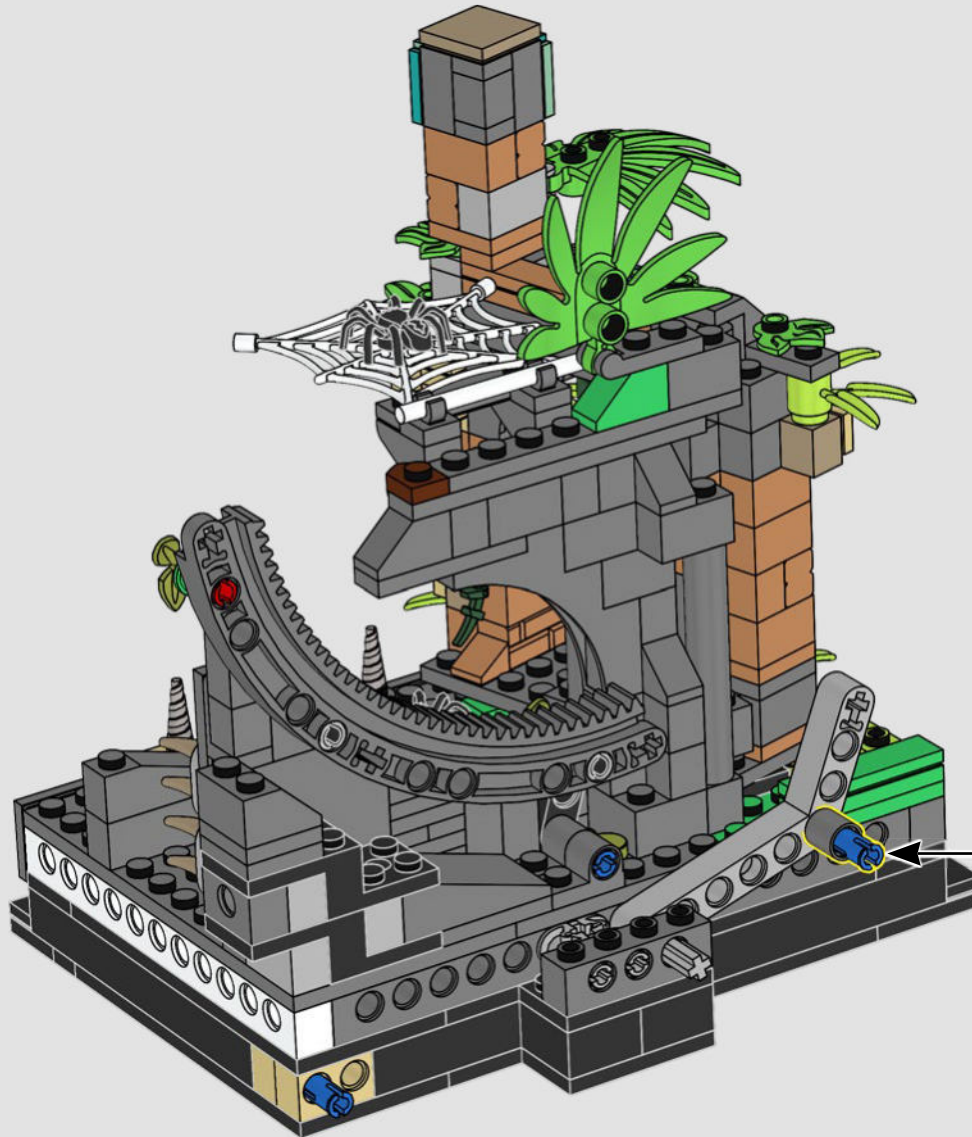

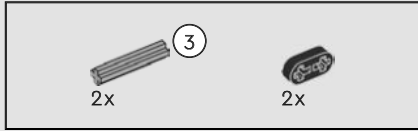
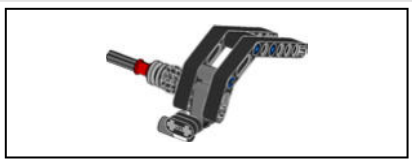

99

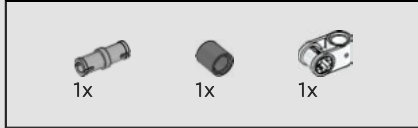
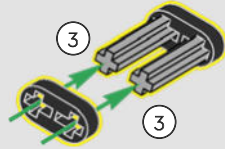

100

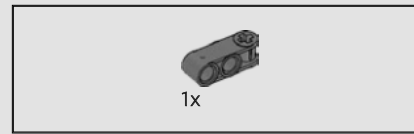
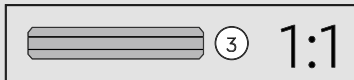
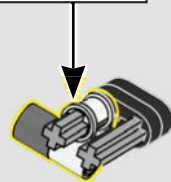
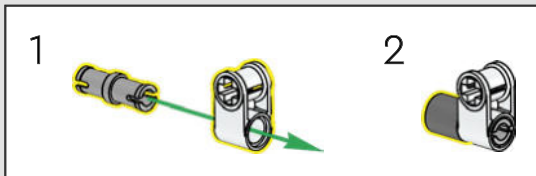

101

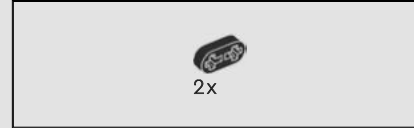
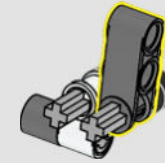

102

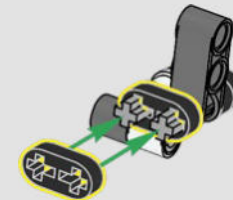

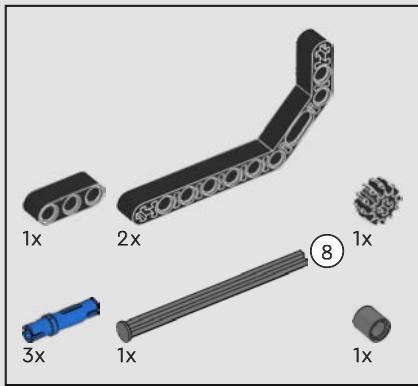

103

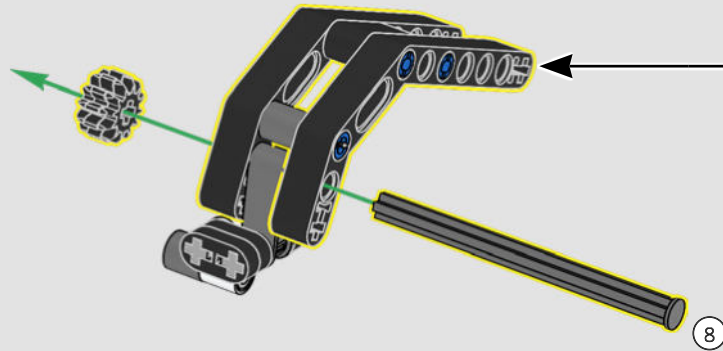
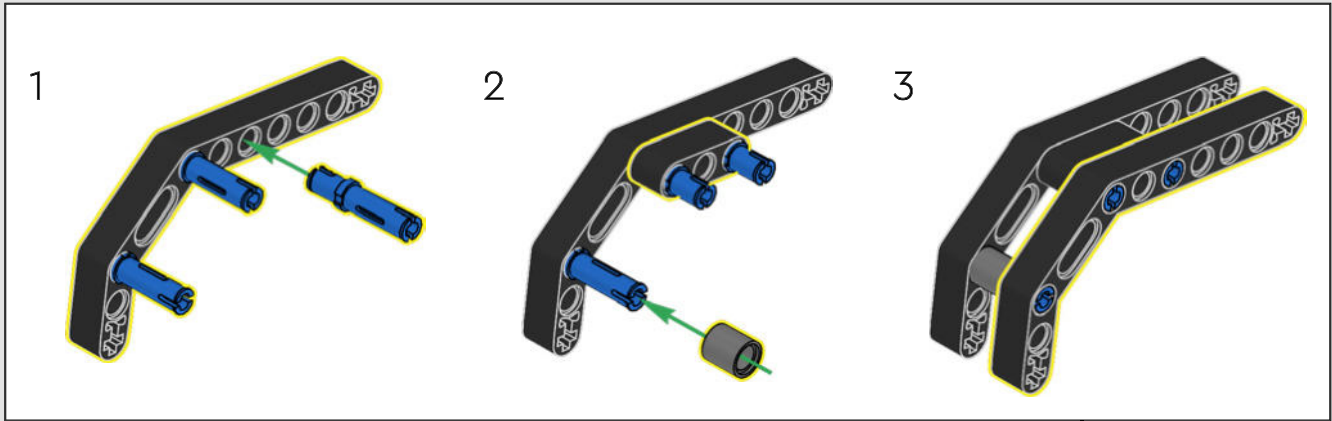
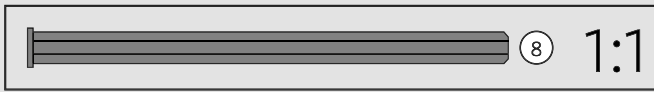

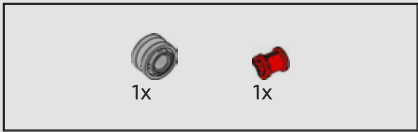

104

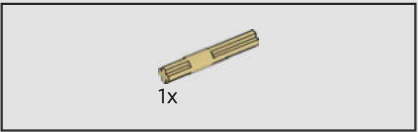
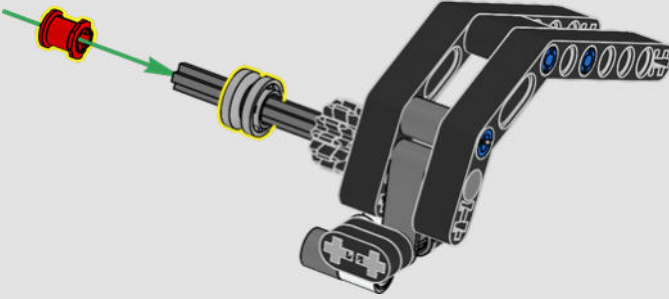

105

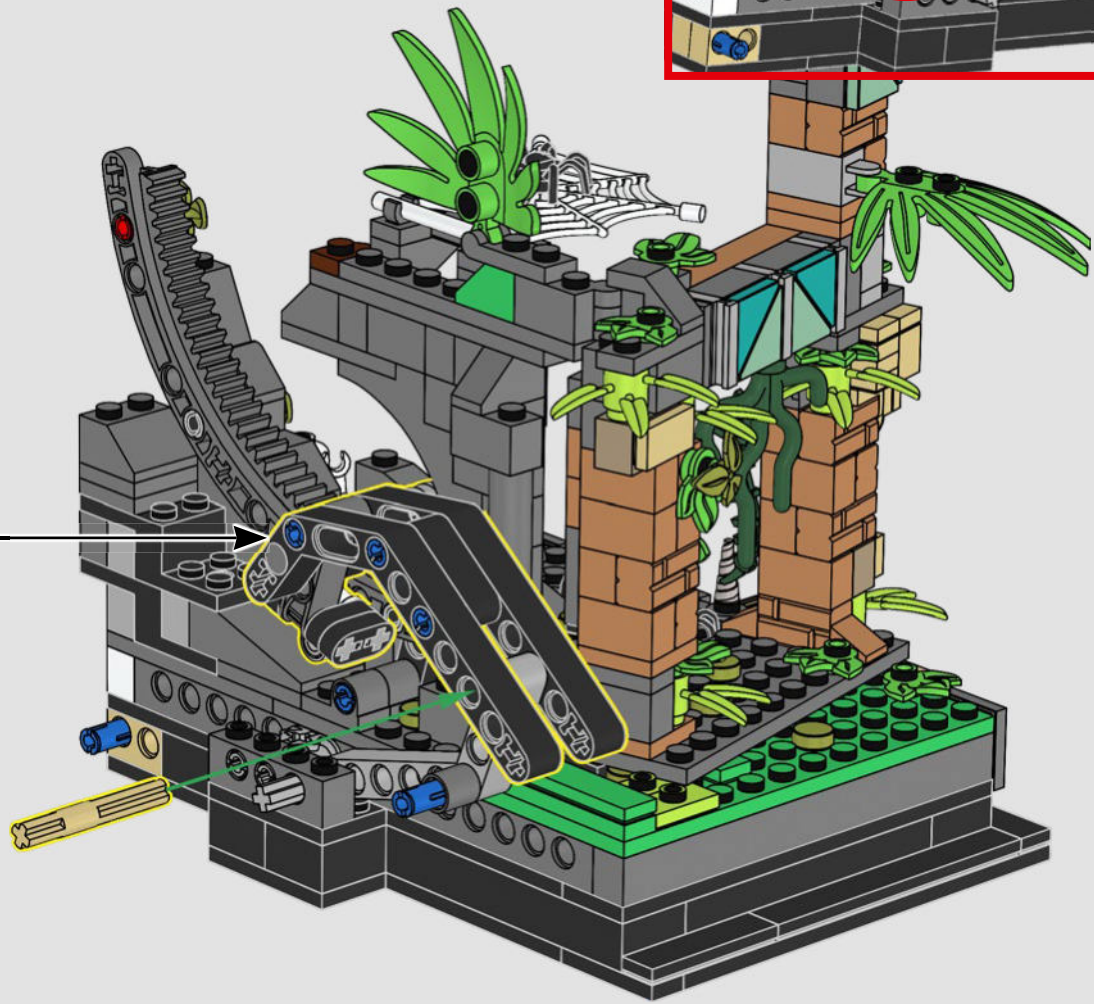
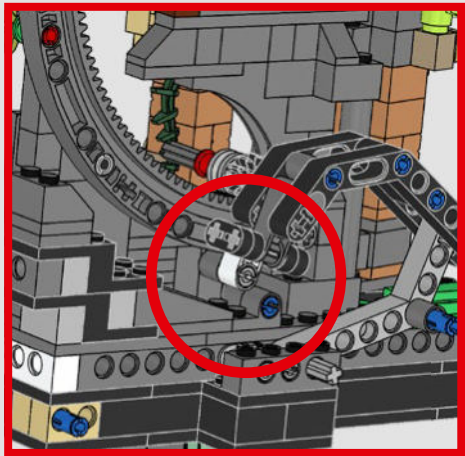

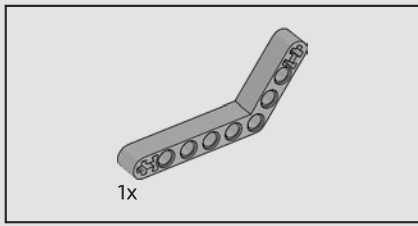

106

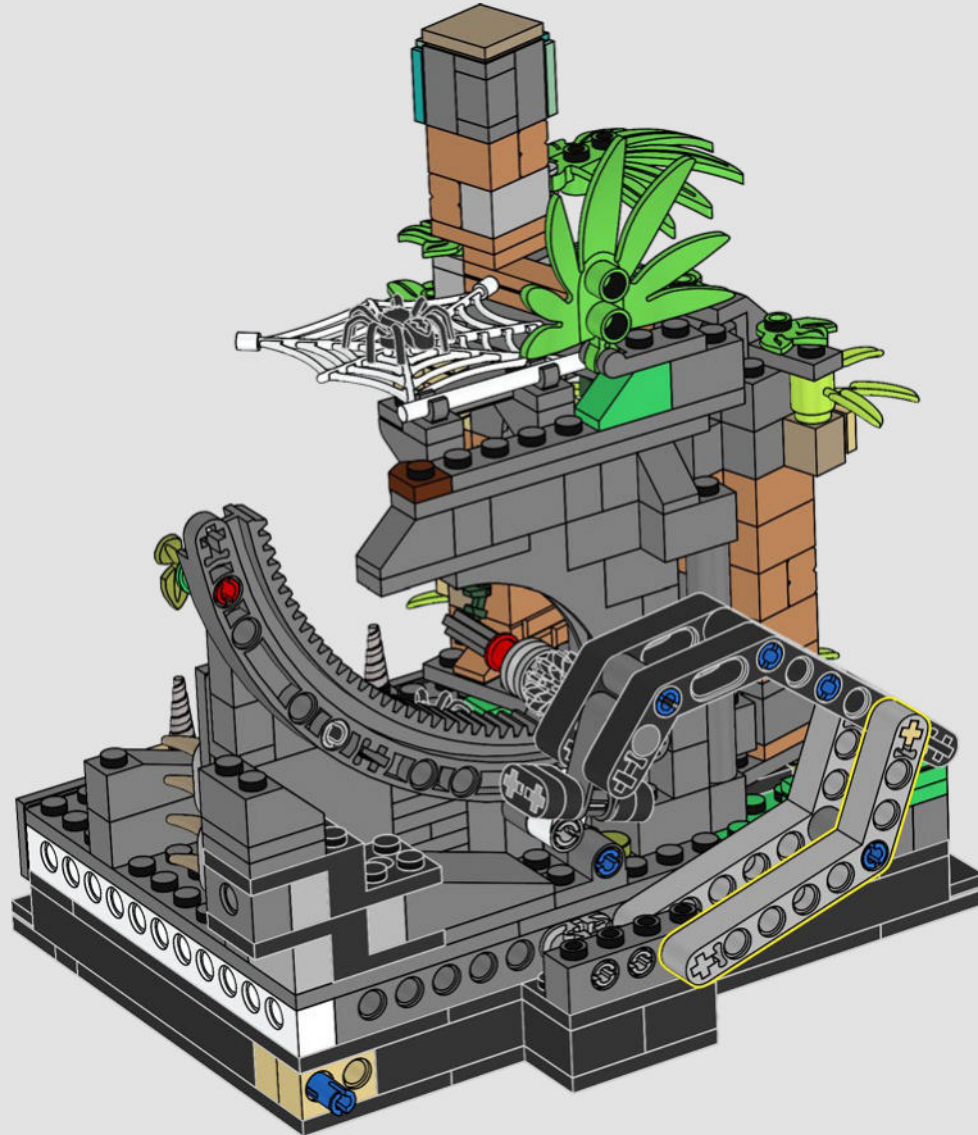

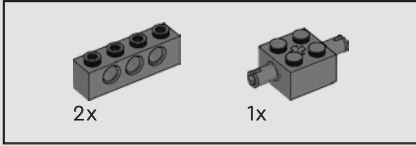
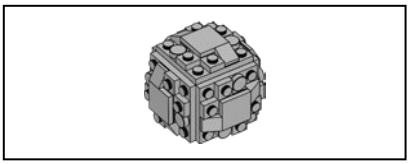

107

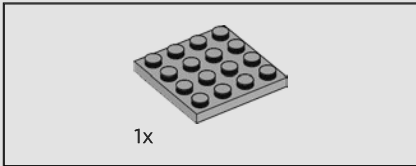
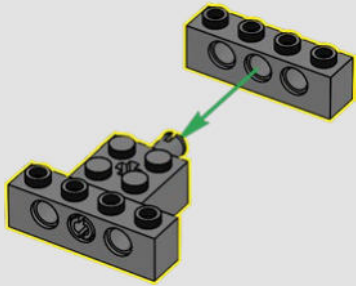

108

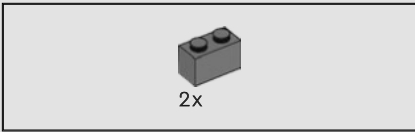
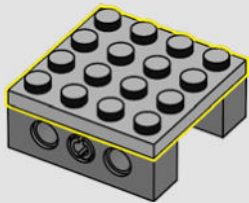

109

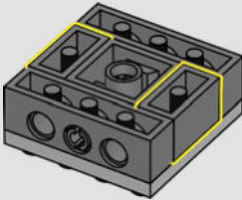

110

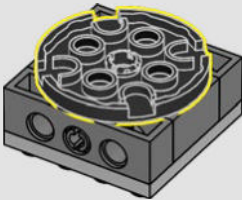

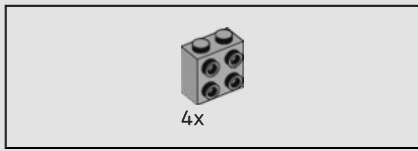

111

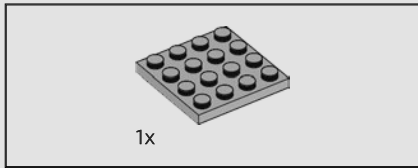
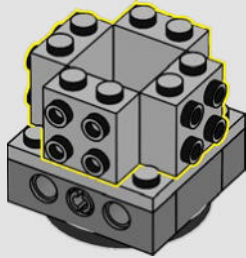

112

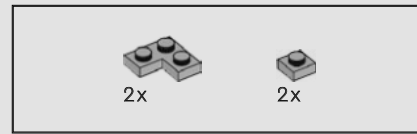
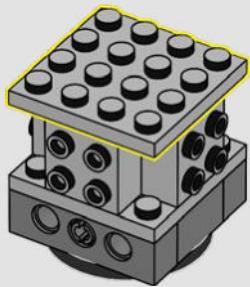

113

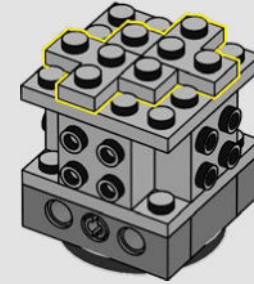

114

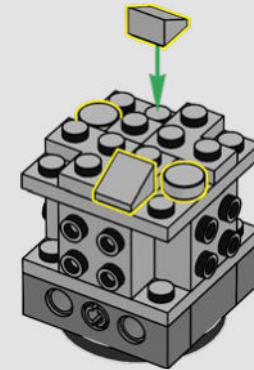

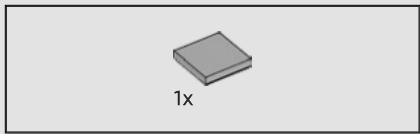

115

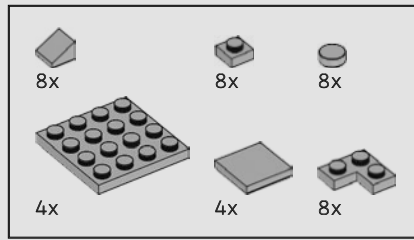
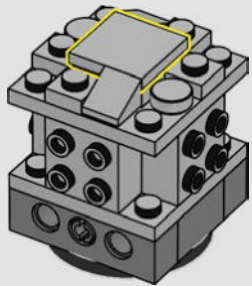

116

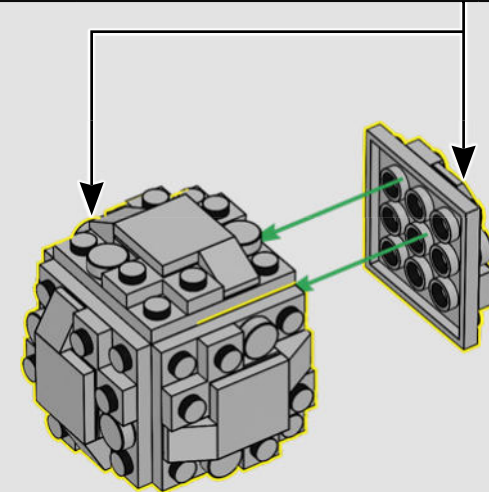
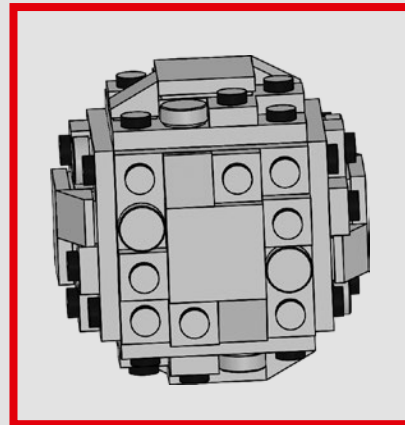
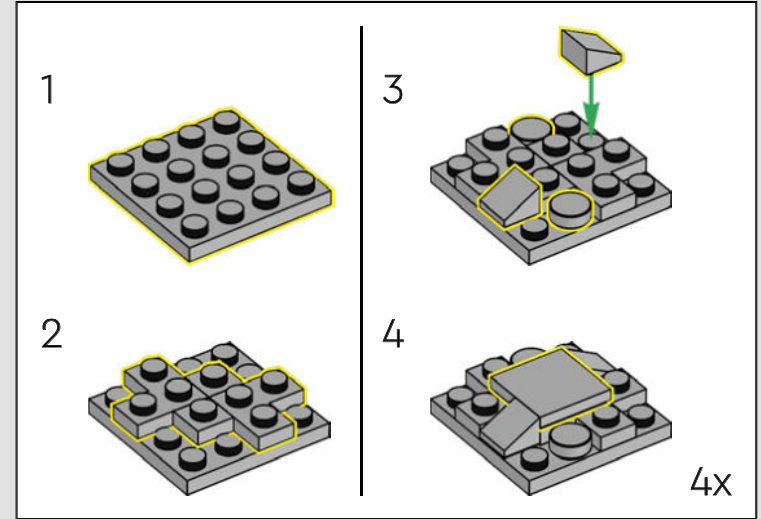

117

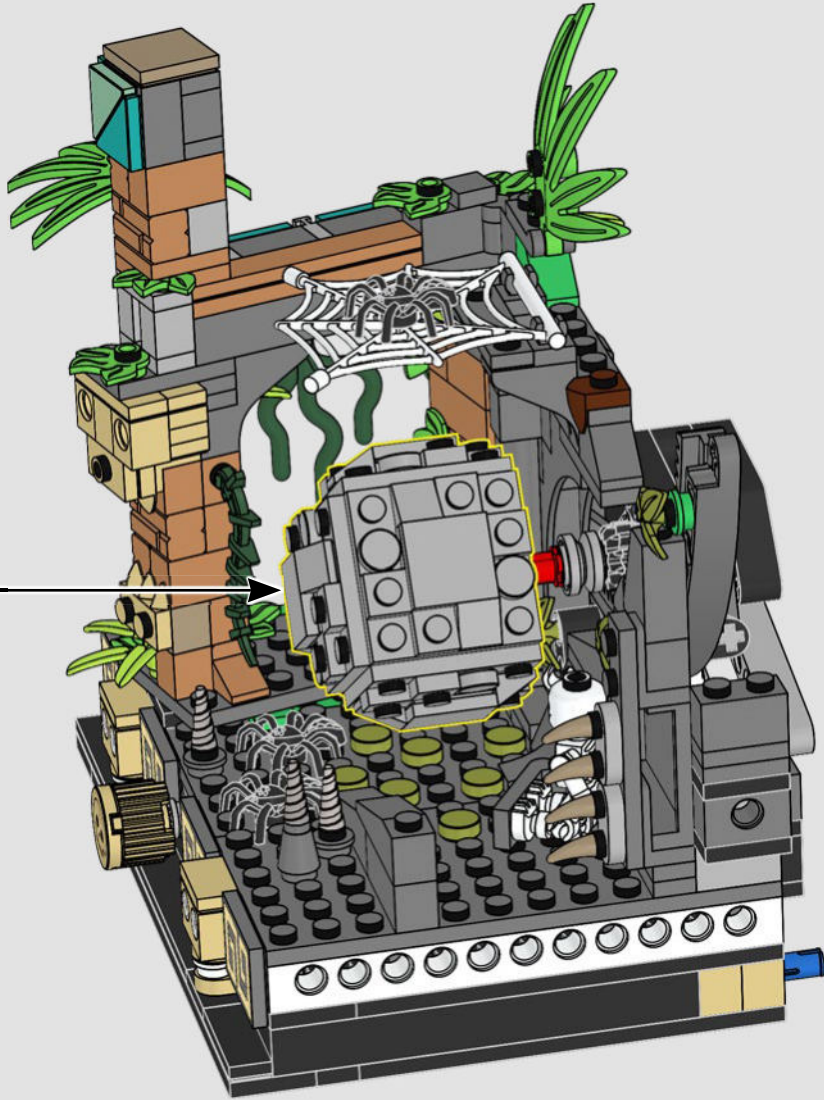

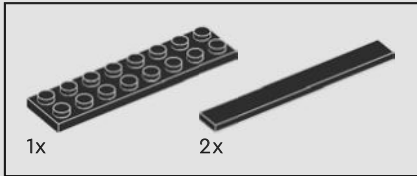

118

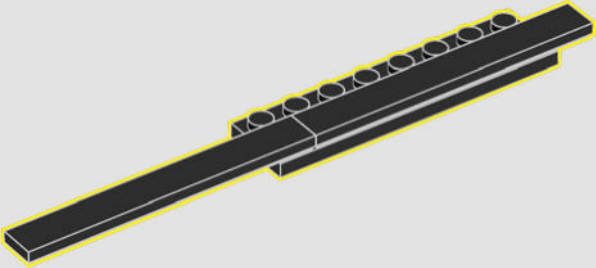

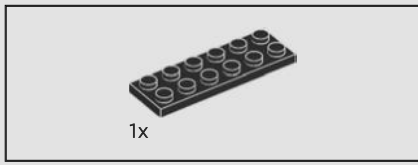

119

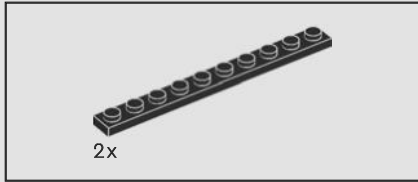
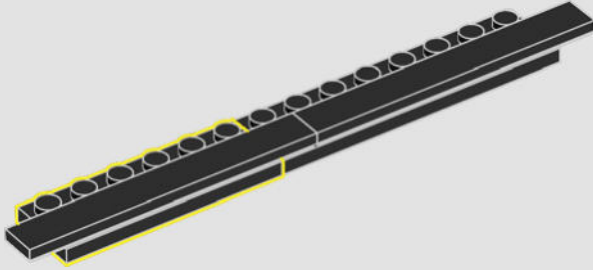

120

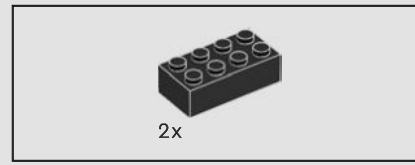
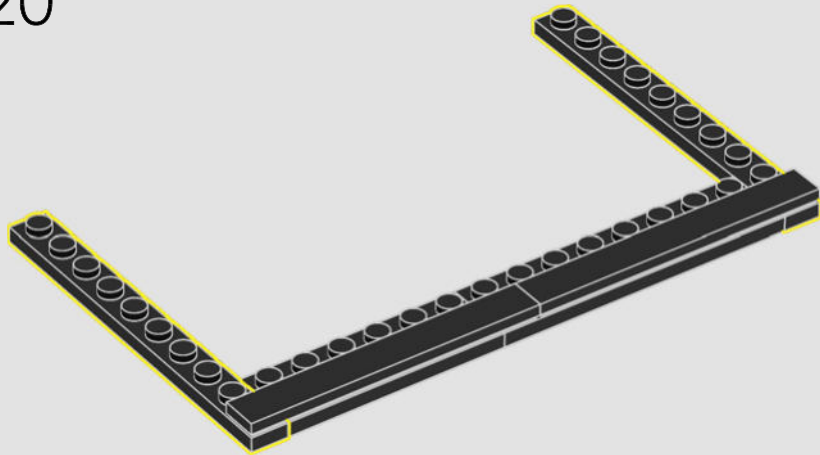

121

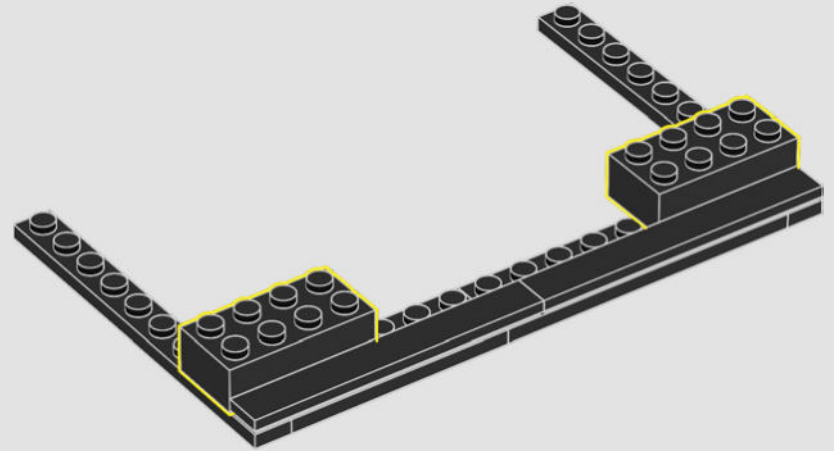

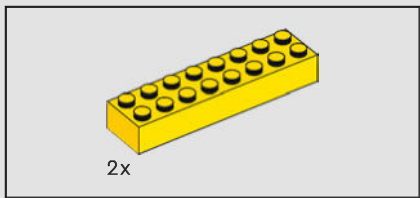

122

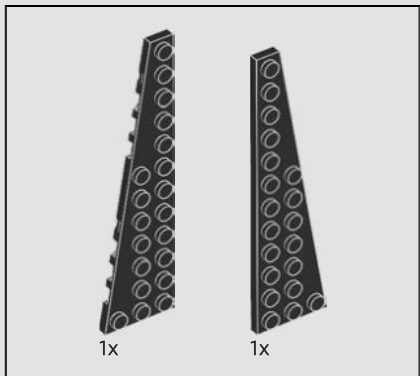
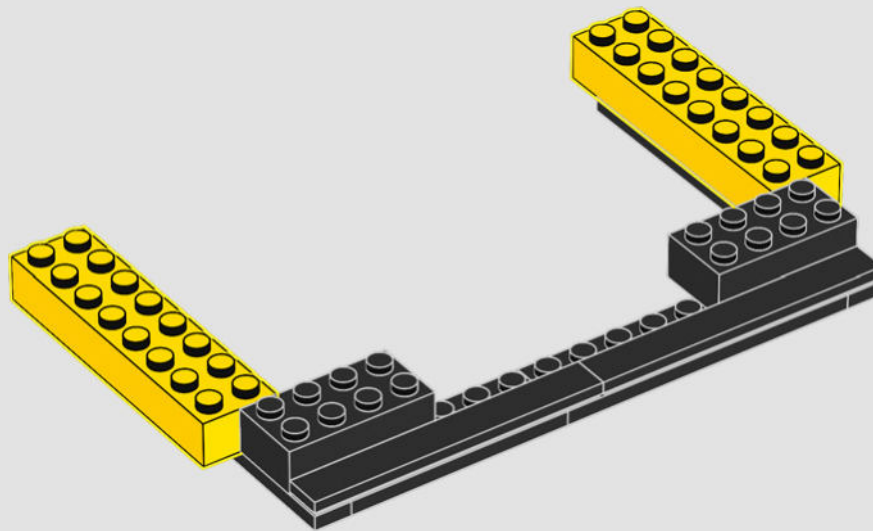

123

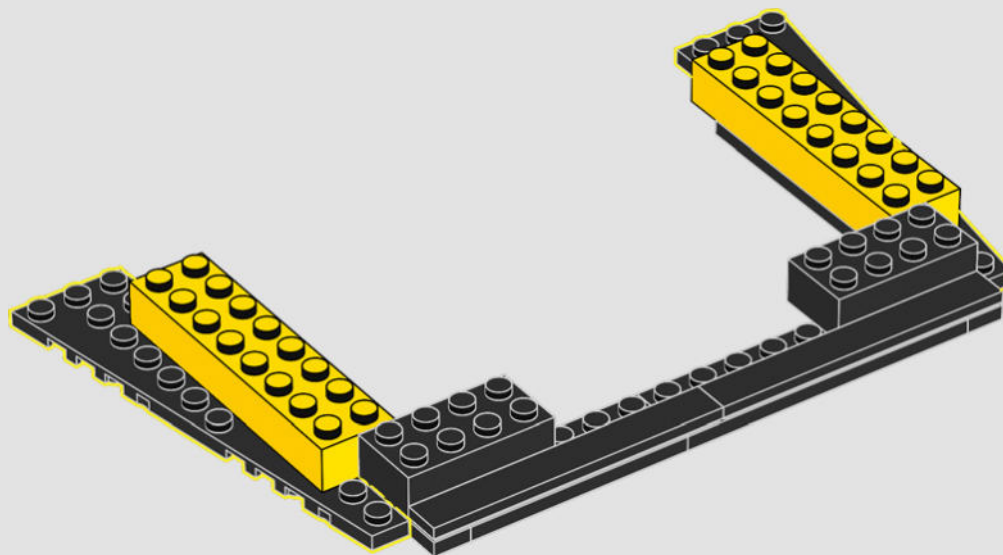

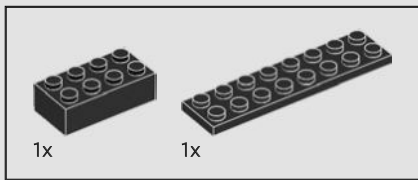

124

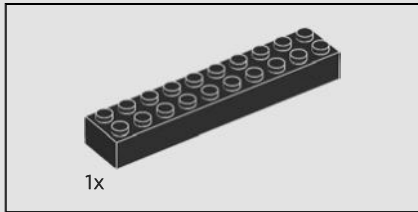
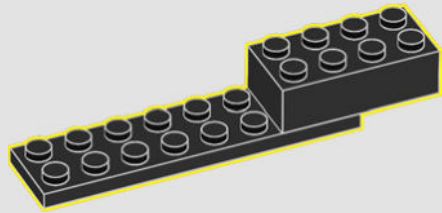

125

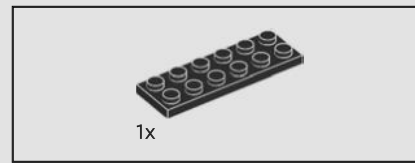
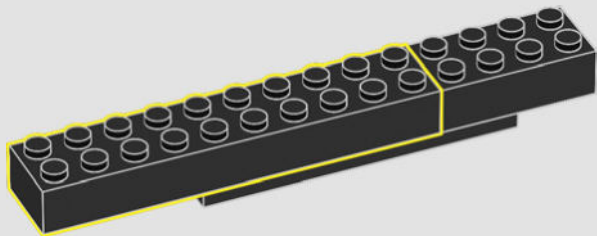

126

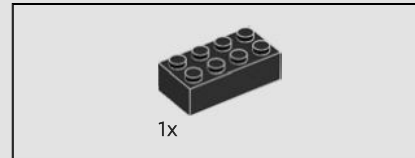
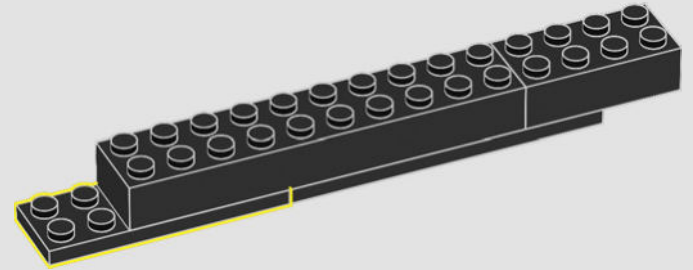

127

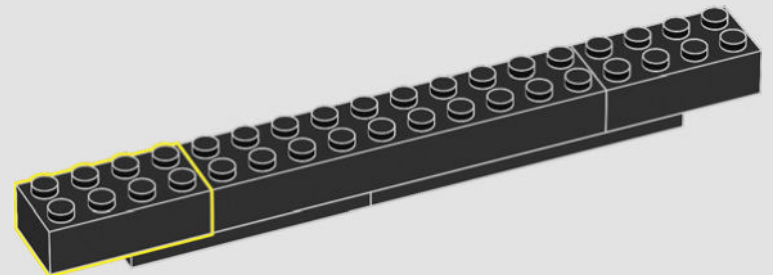

128

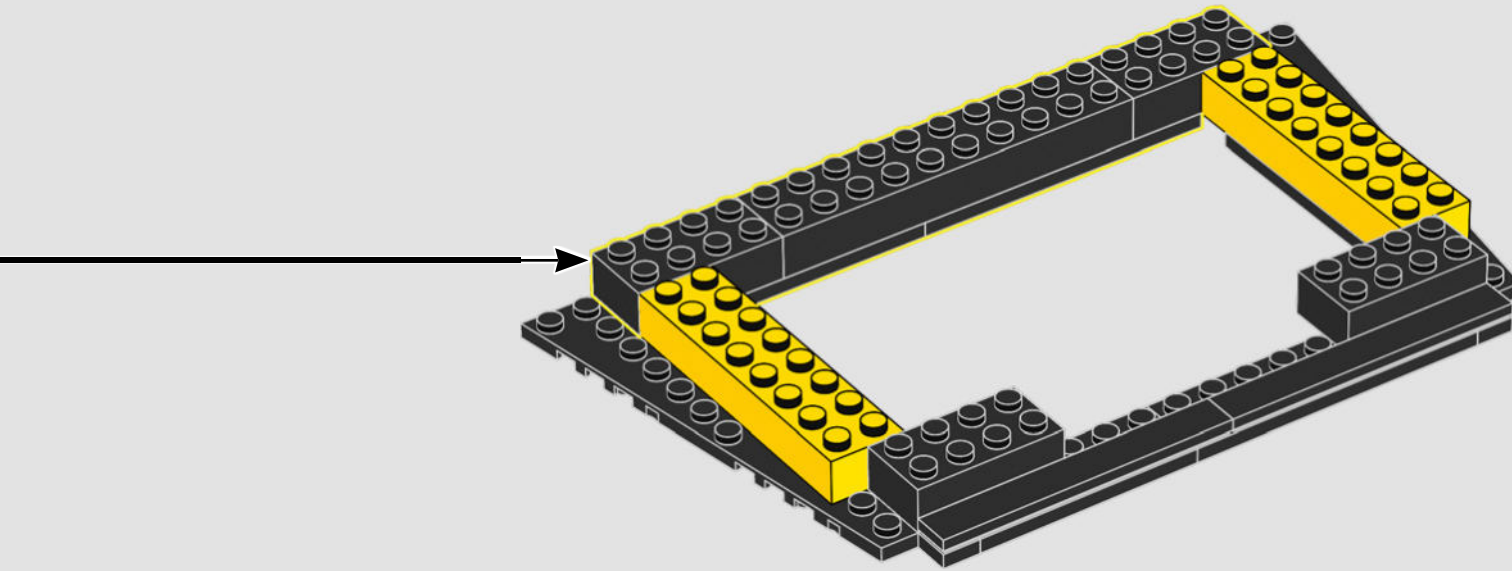

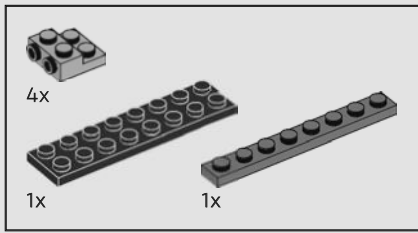

129

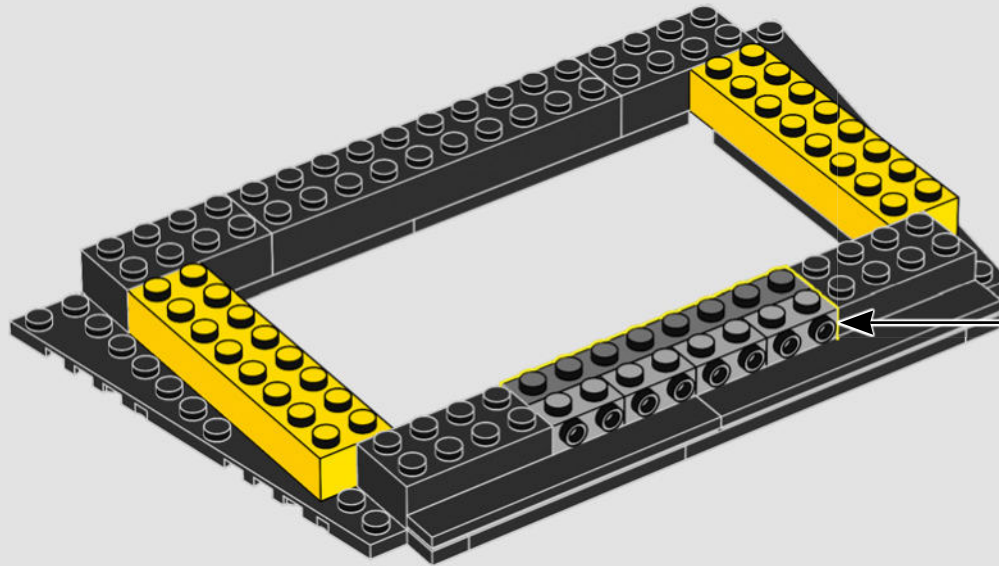
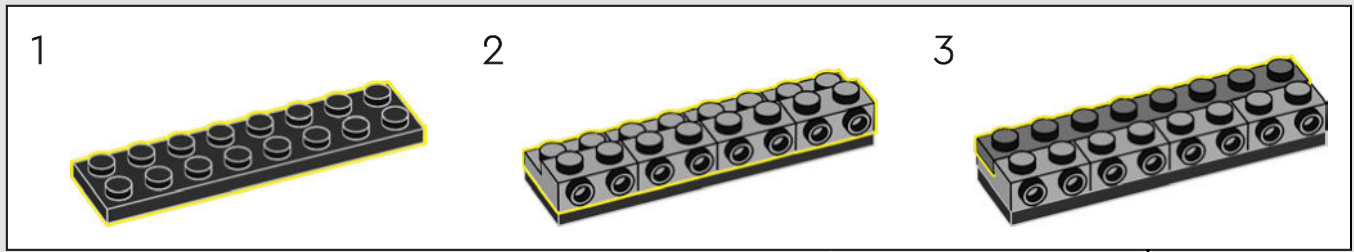



130

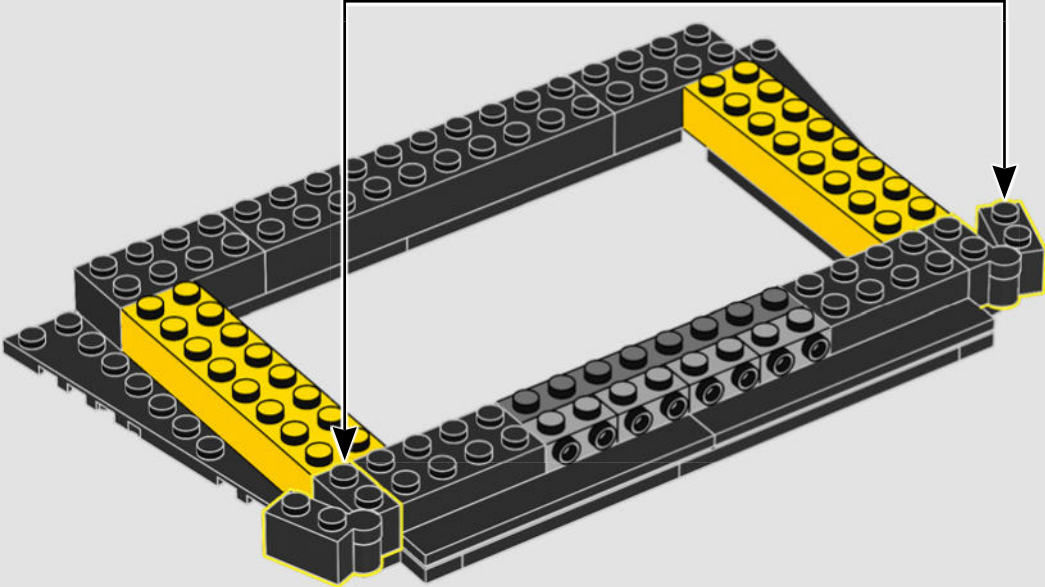
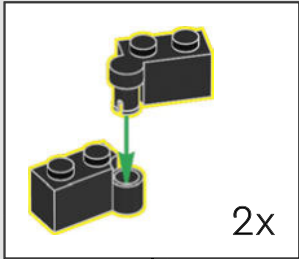

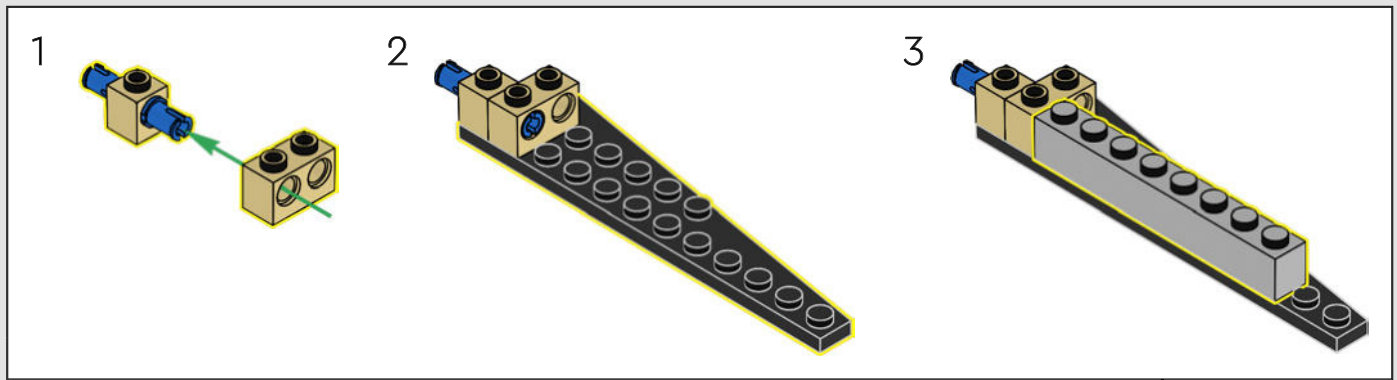
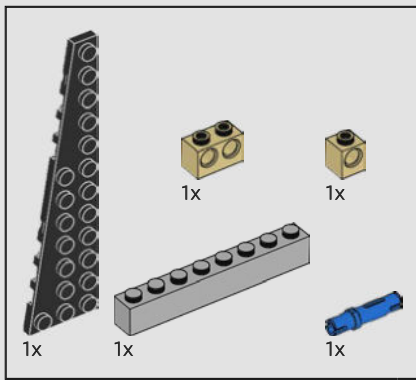

131

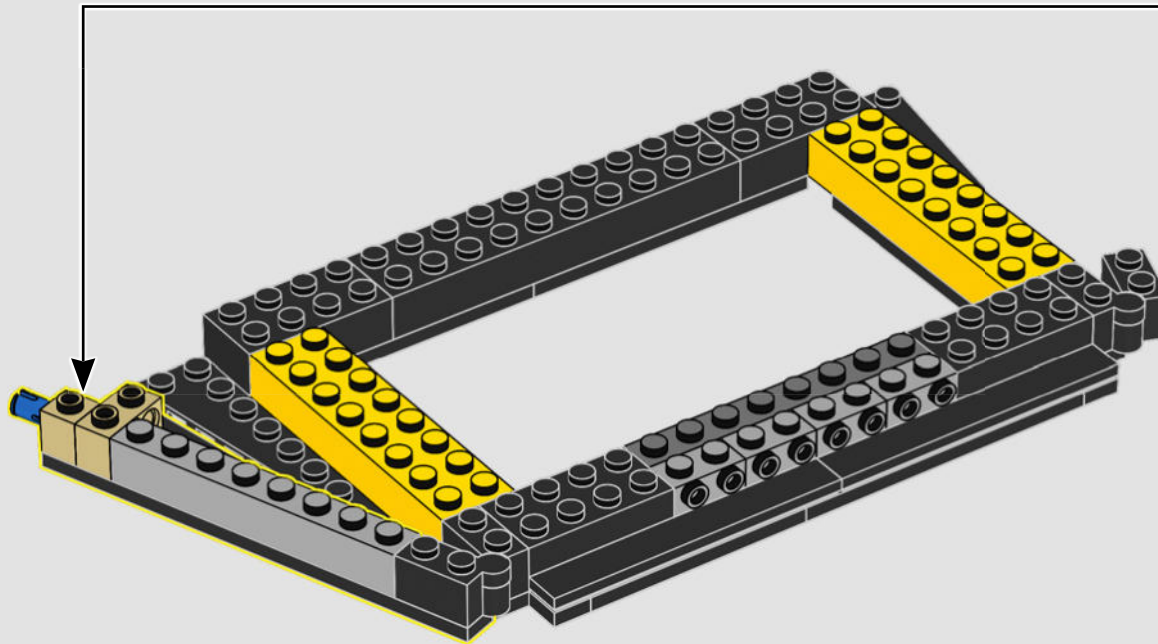

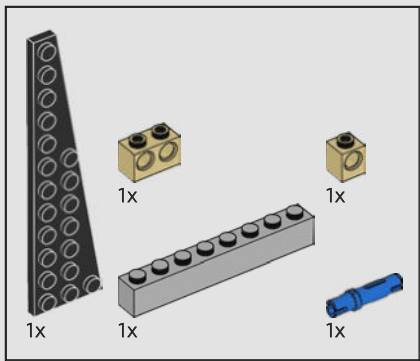

132

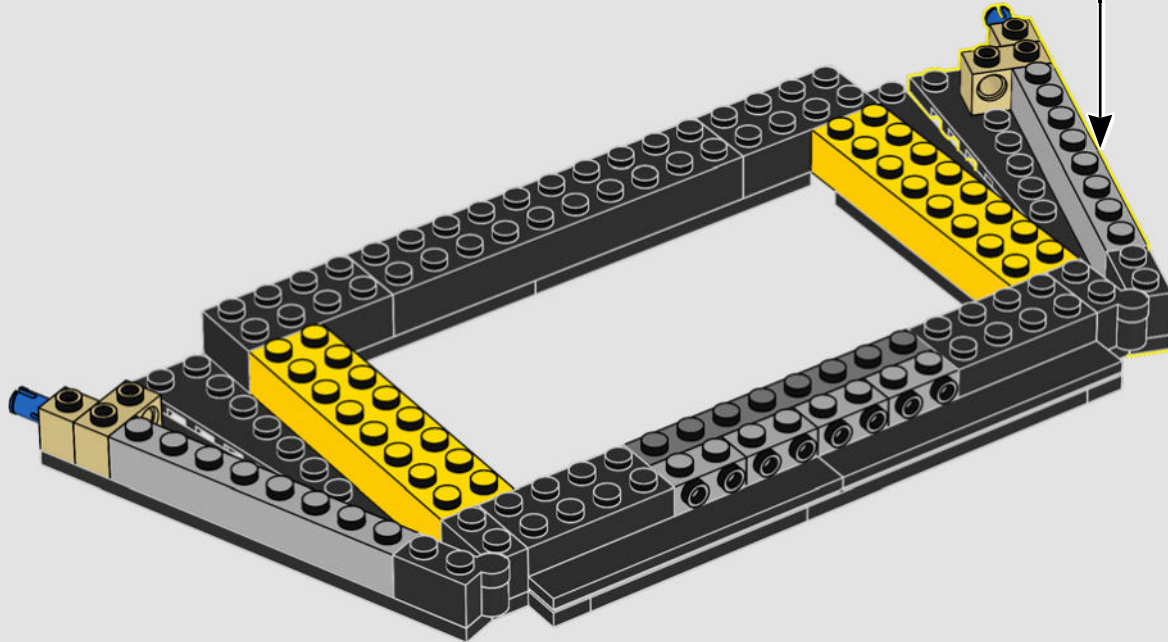
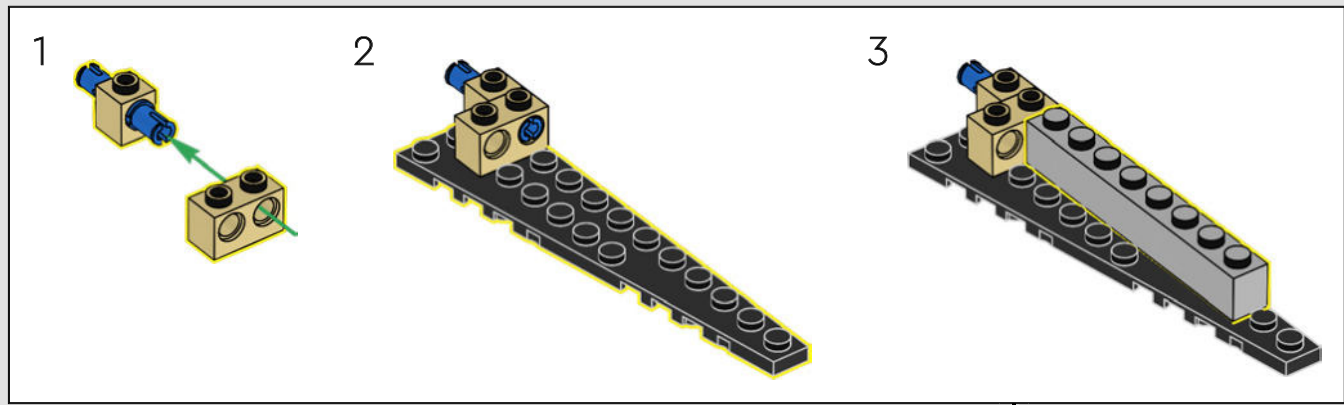

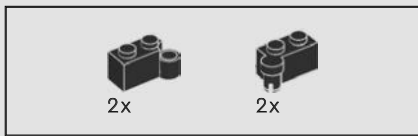

133

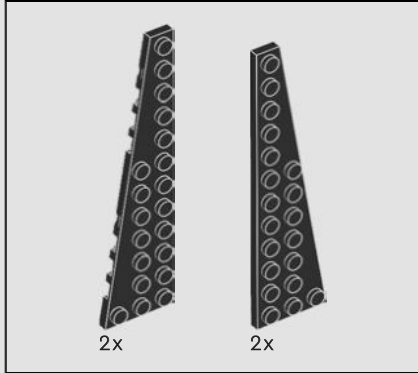
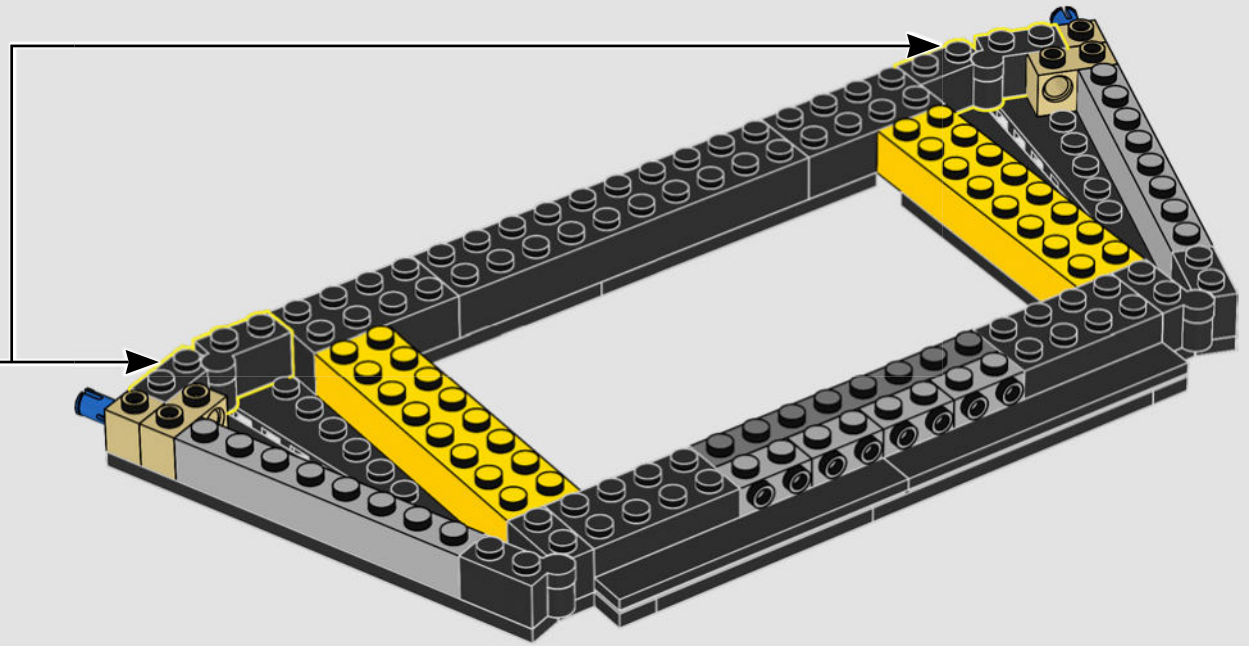
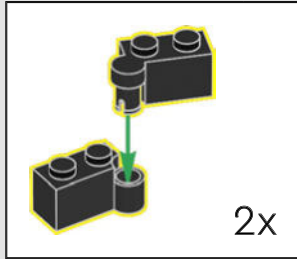

134

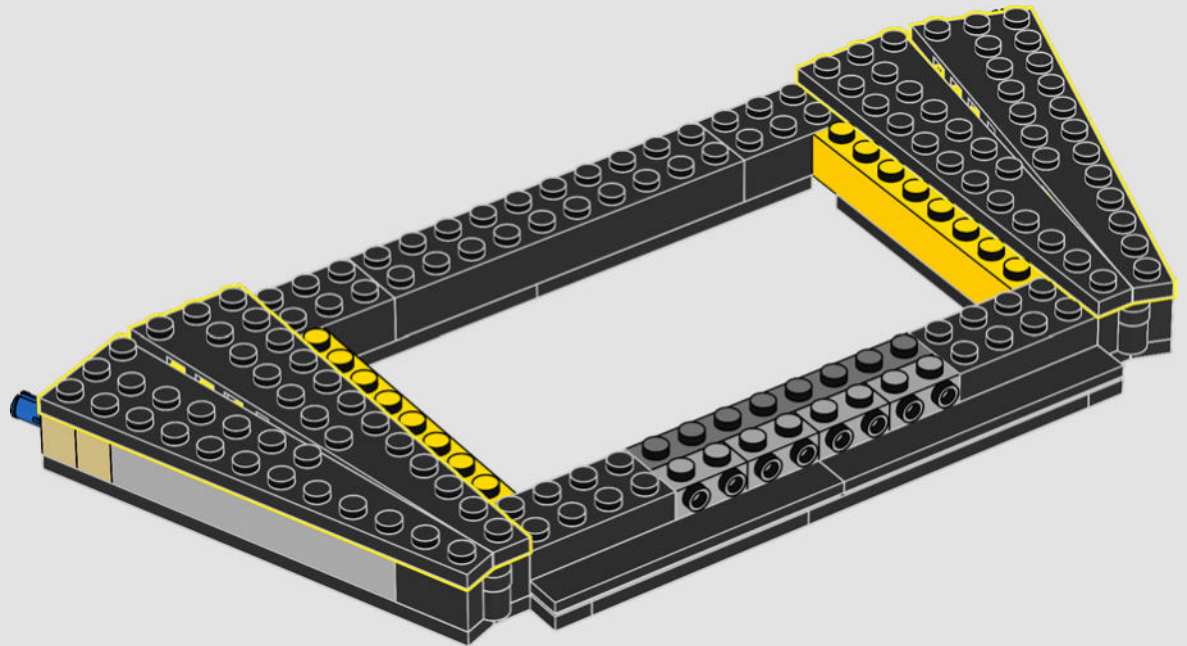

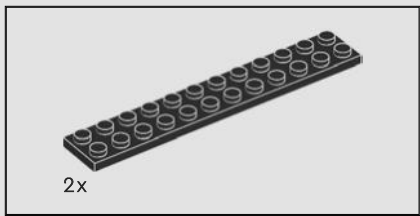

135

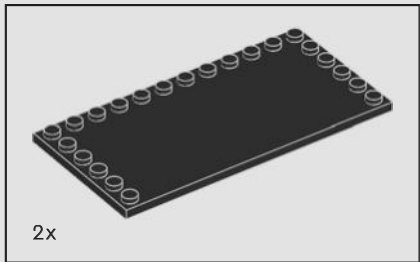
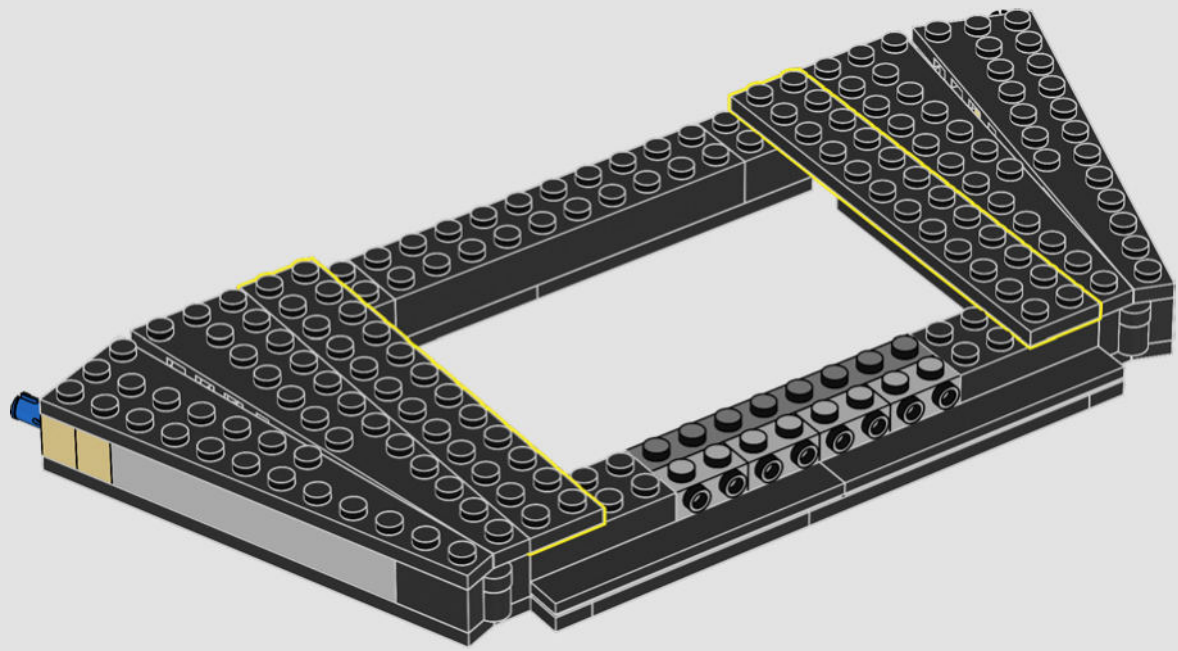

136

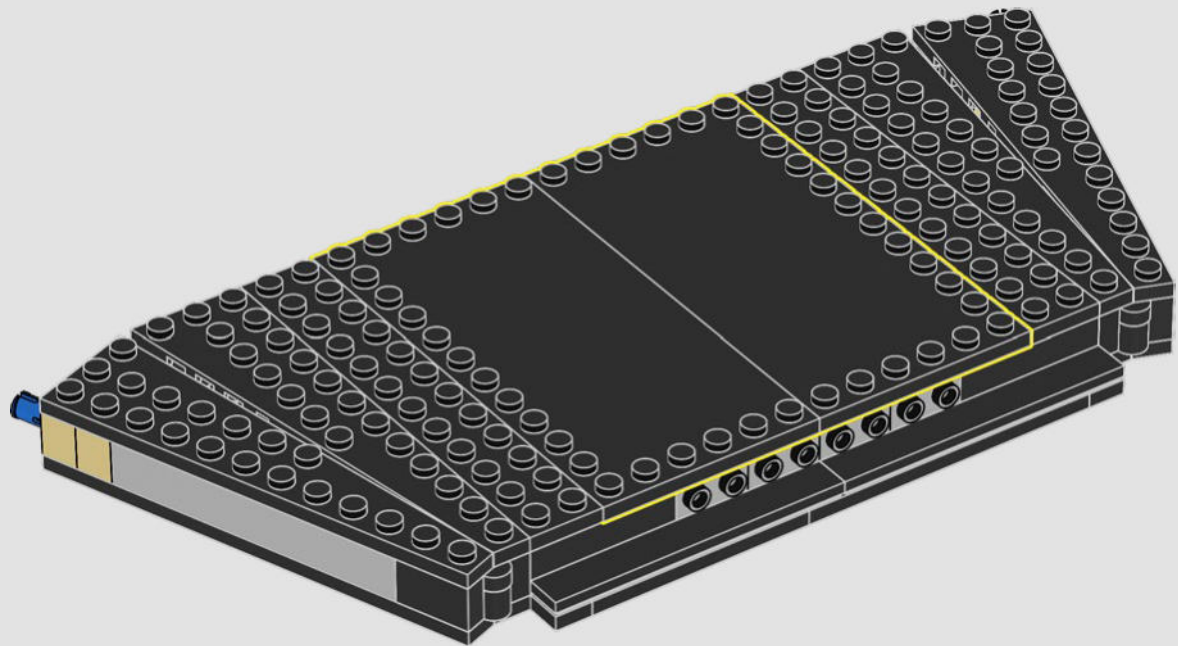

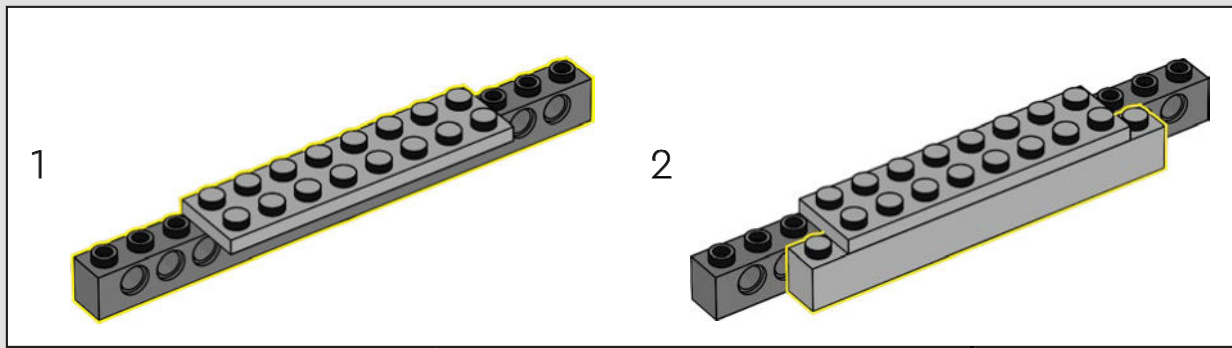
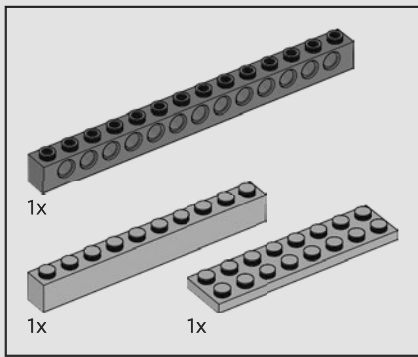

137

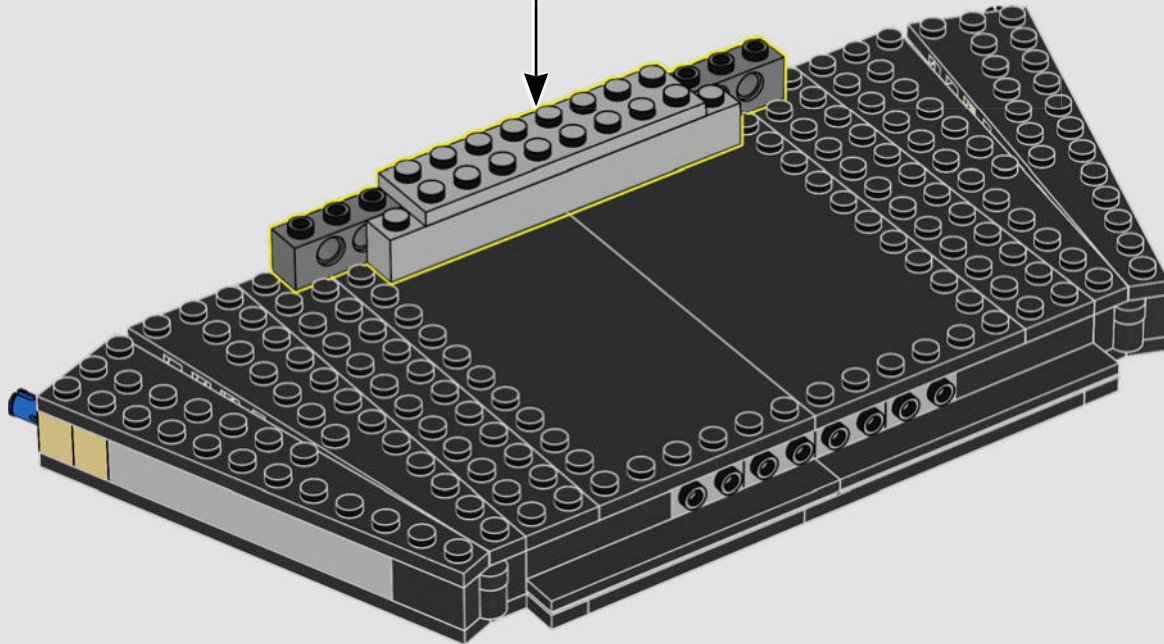

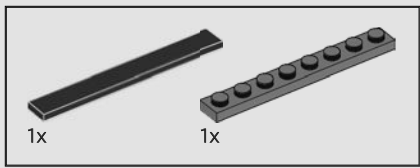

138

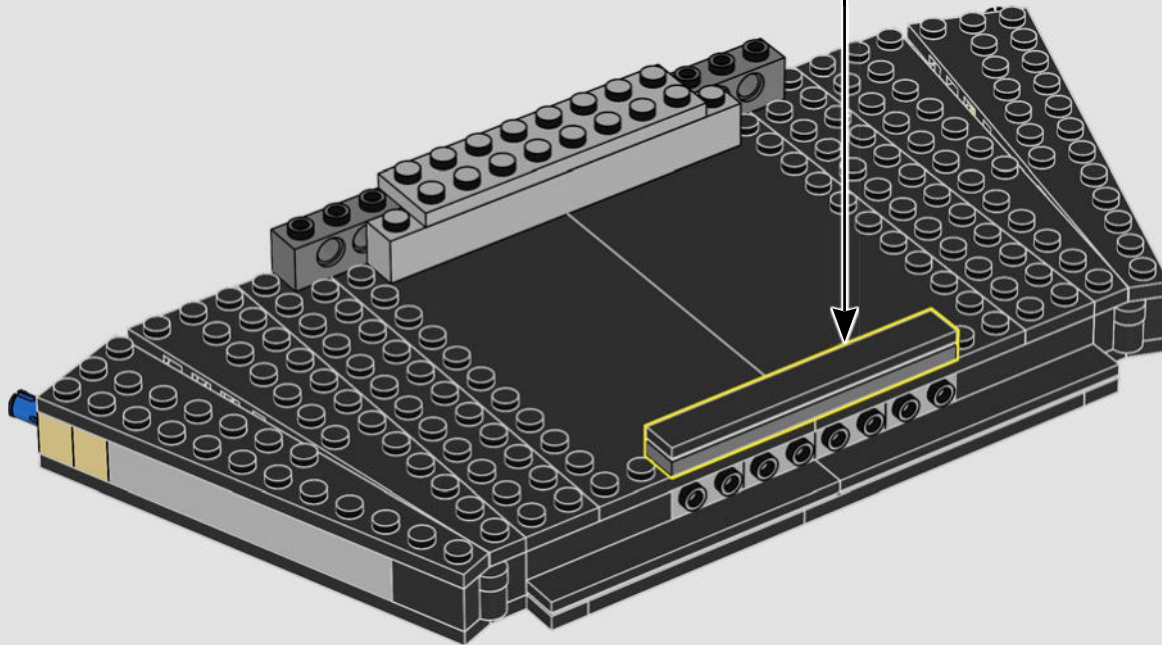
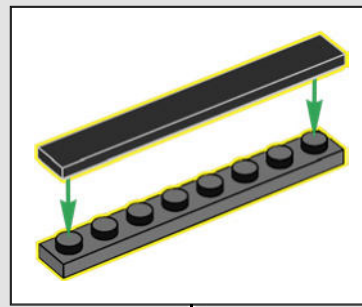

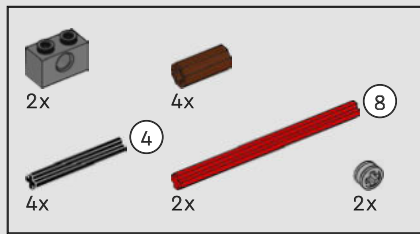

139

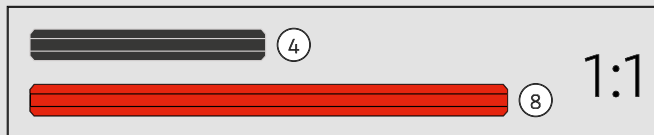
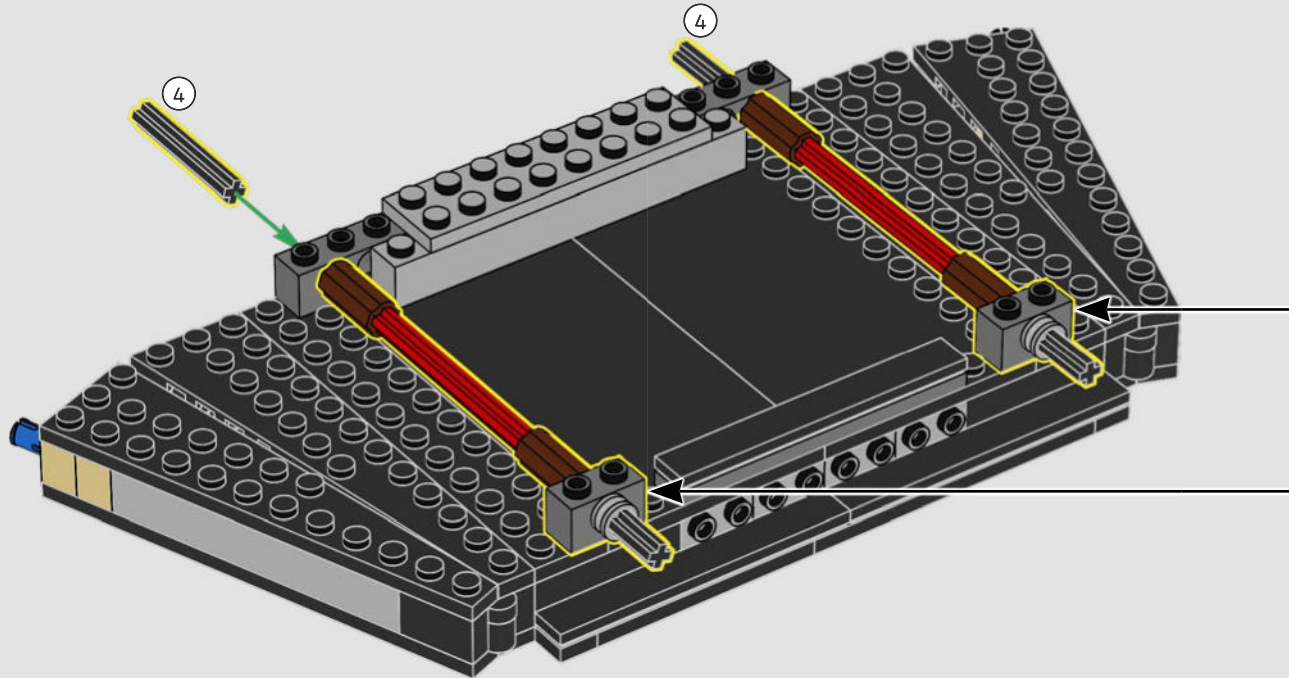
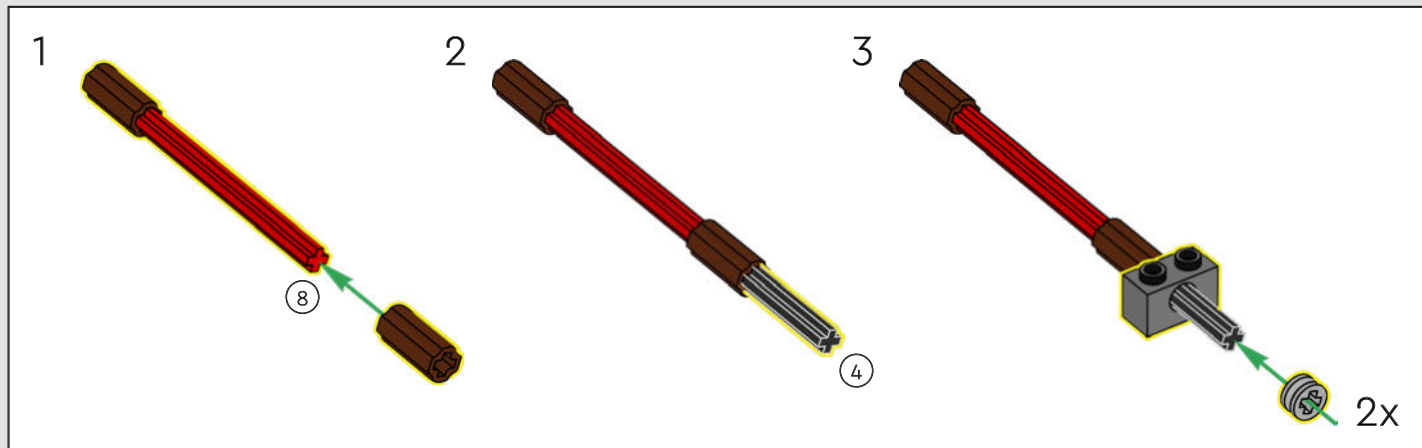

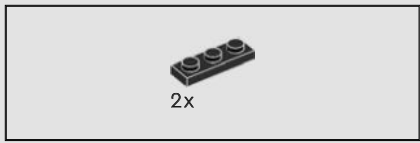

140

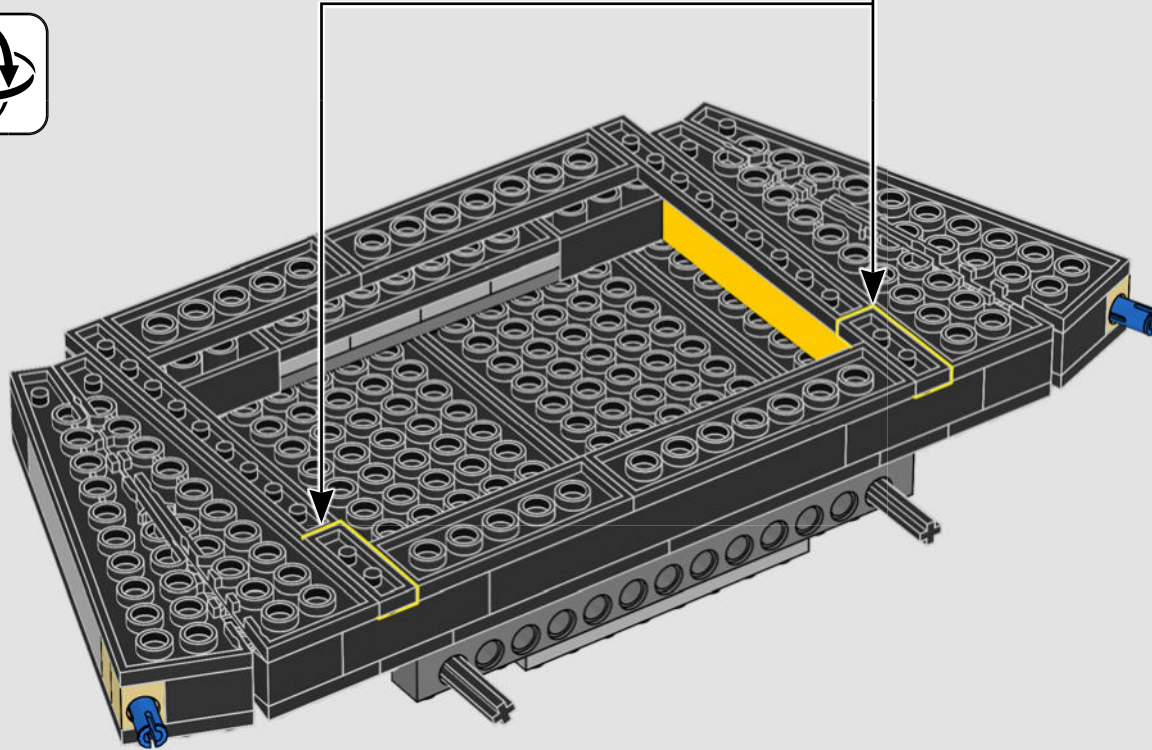
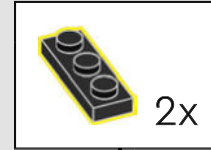

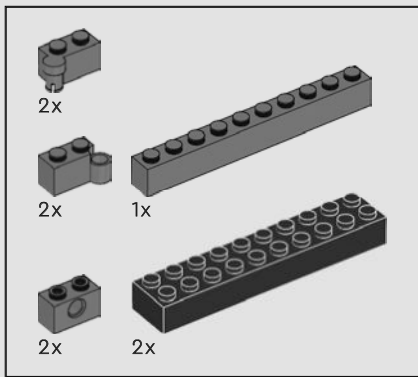

141

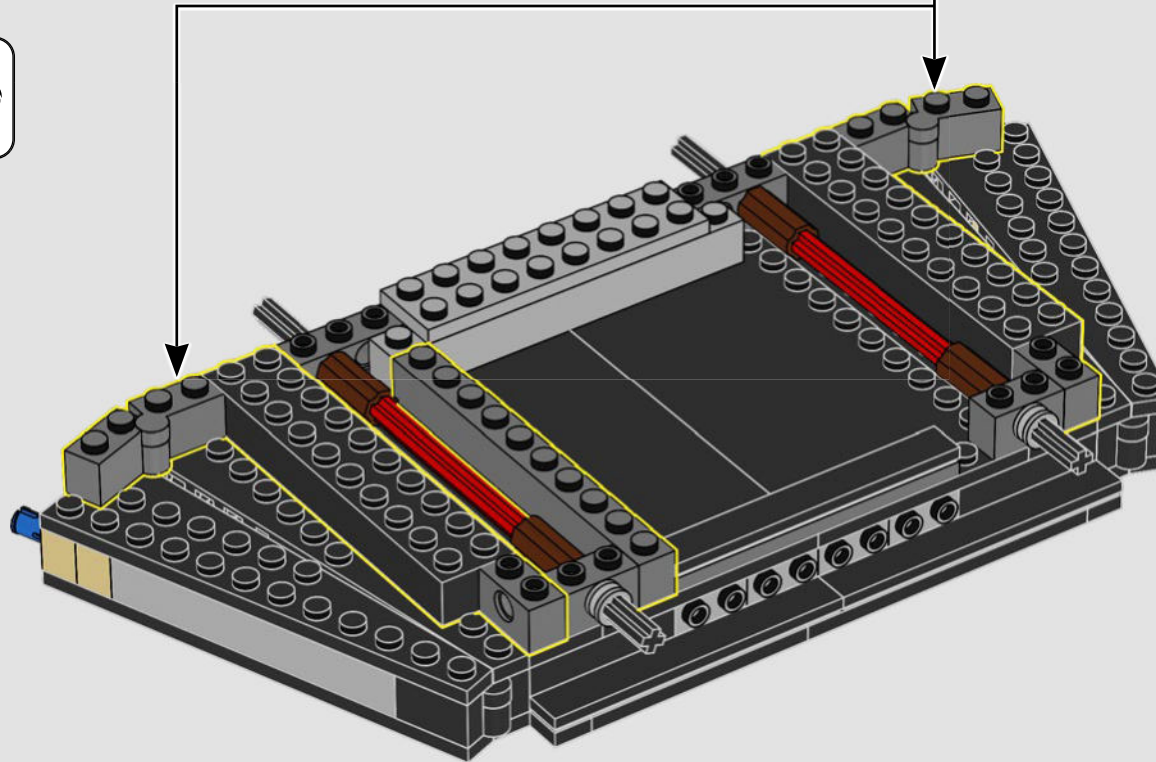
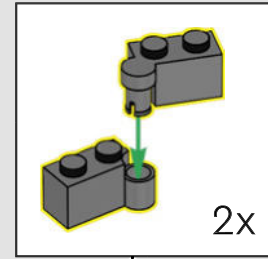

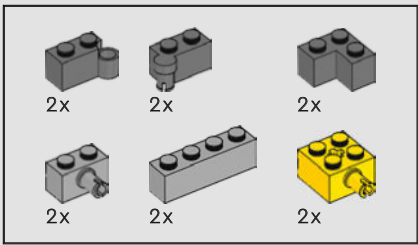

142

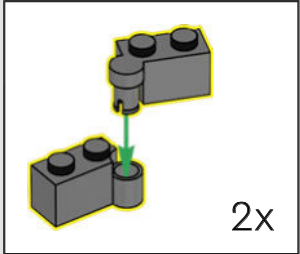
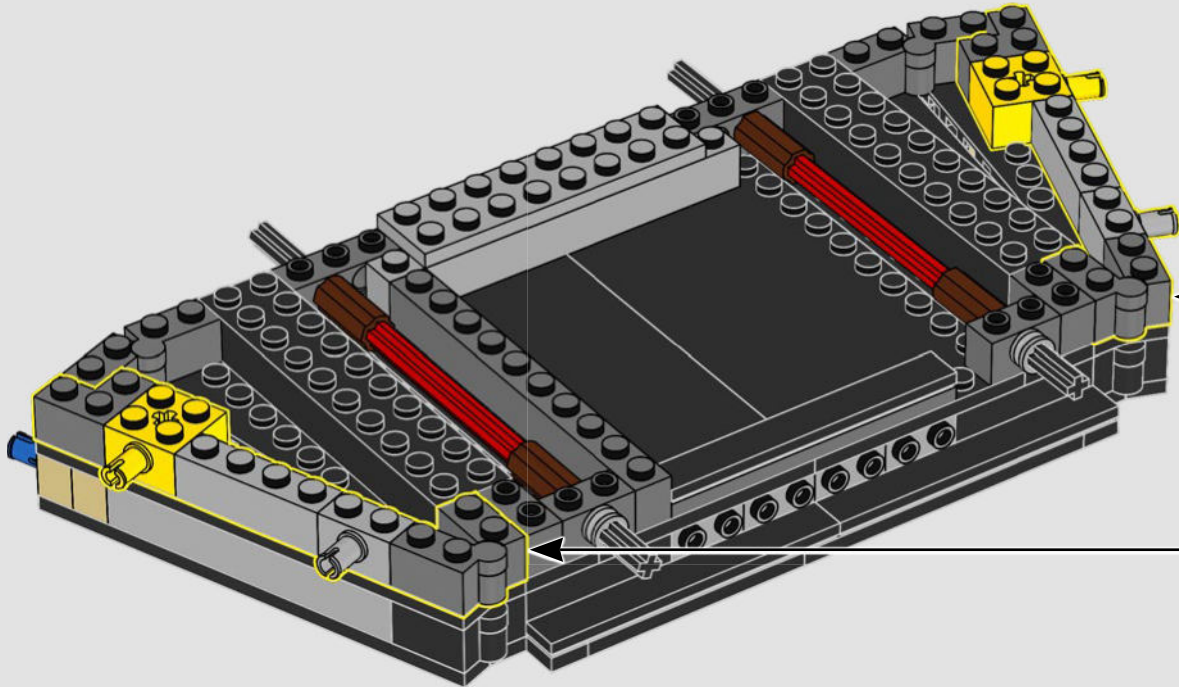

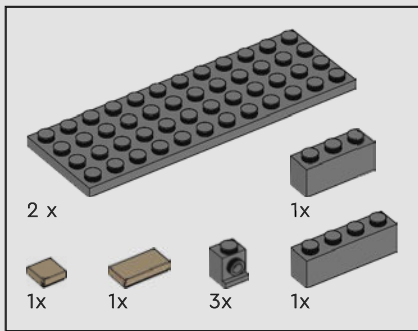

143

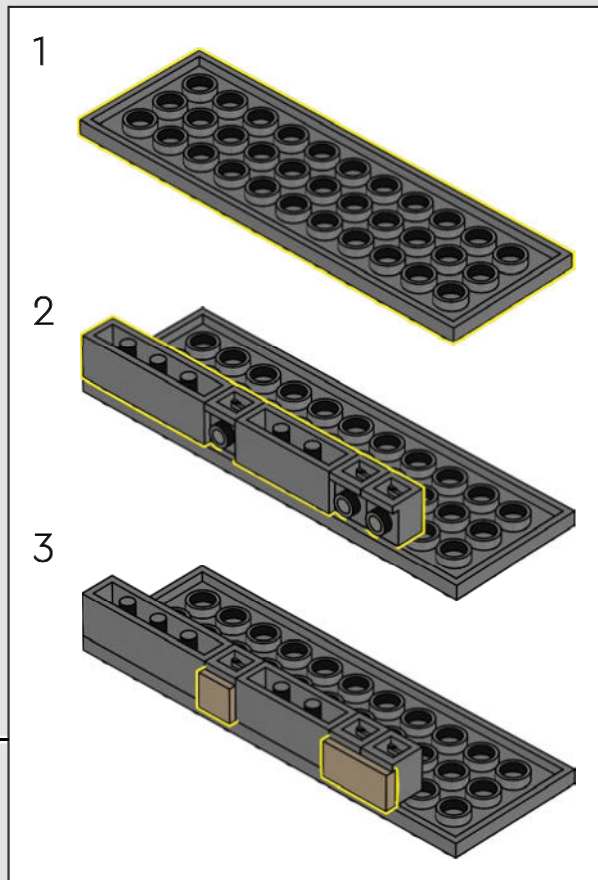
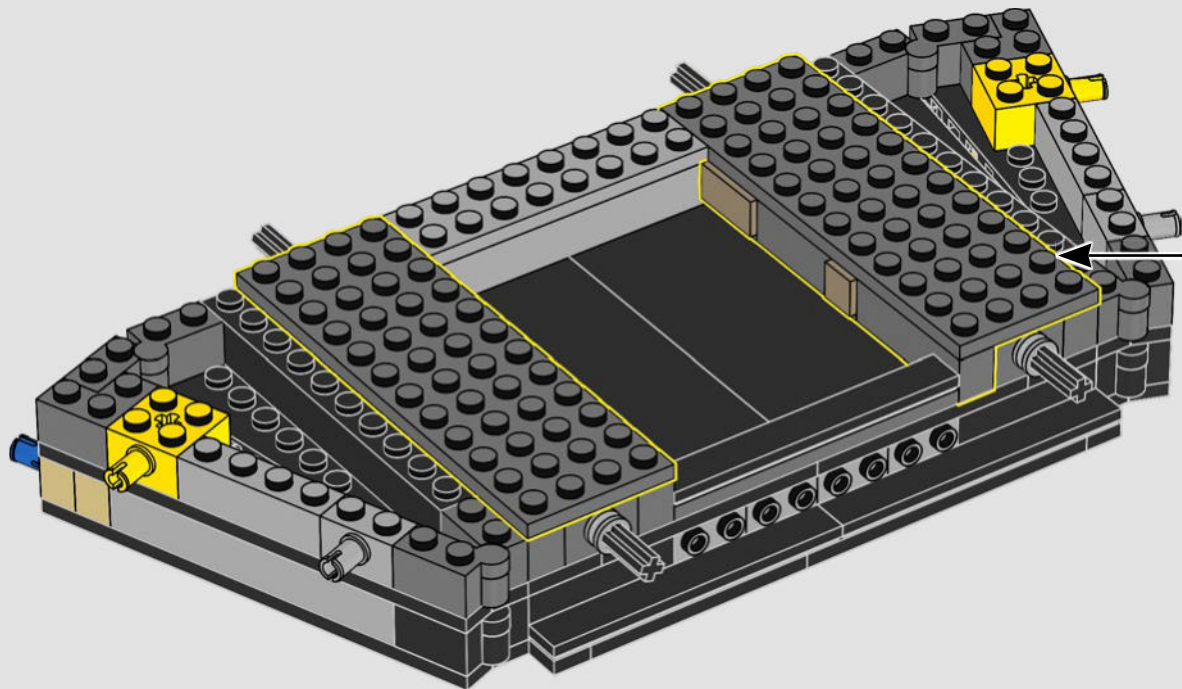

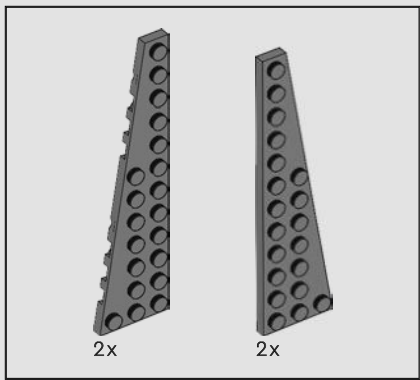

144

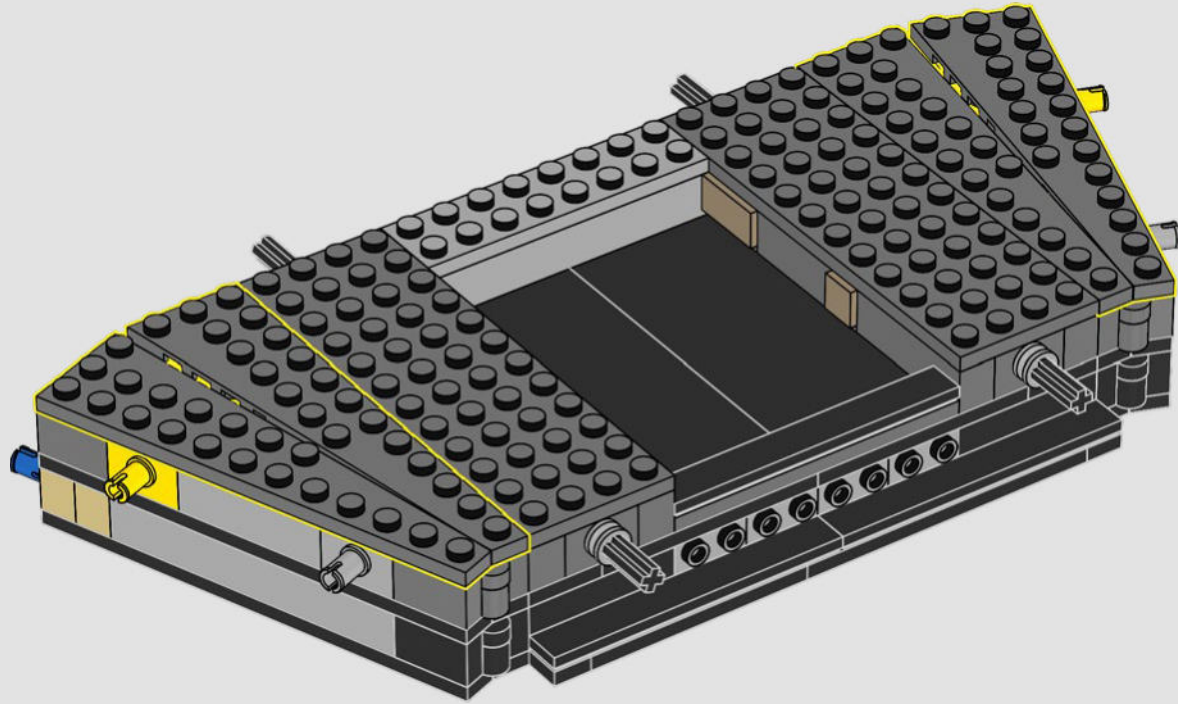



145

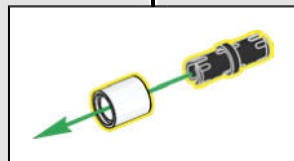
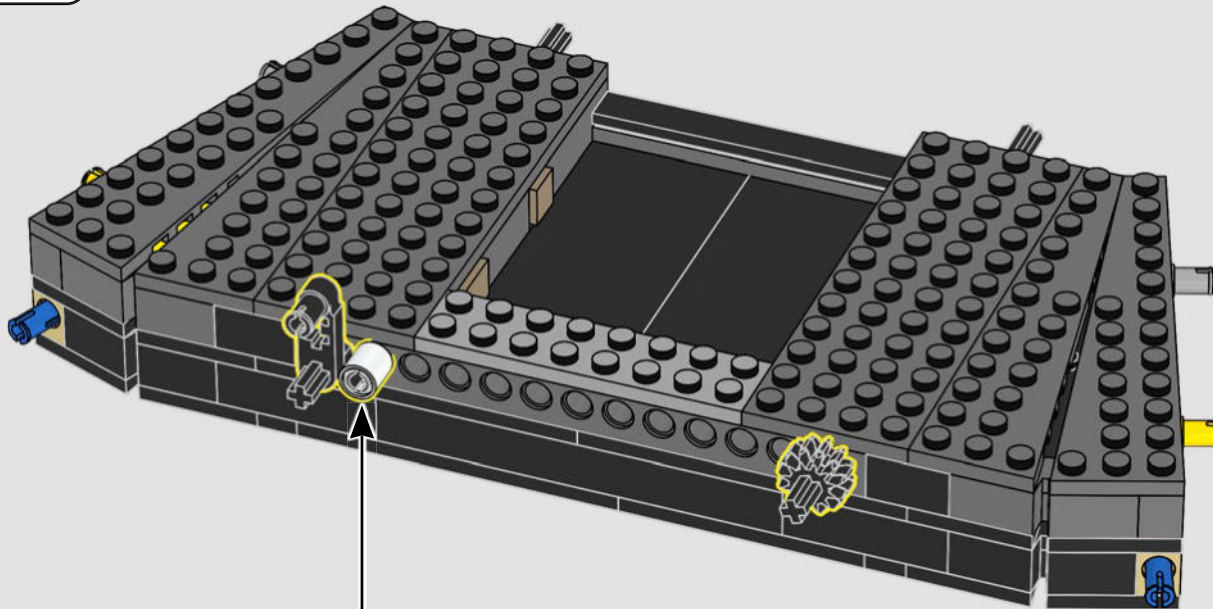

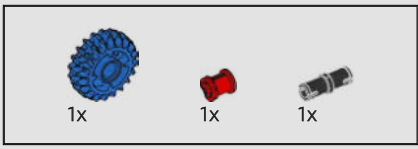

146

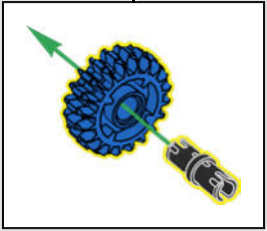
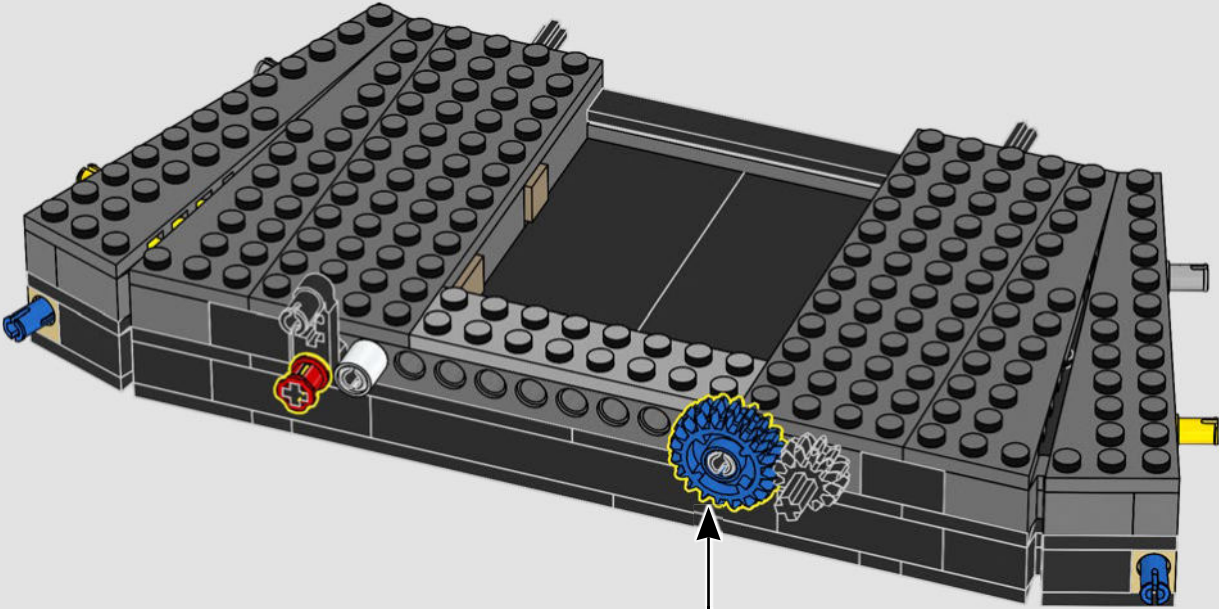

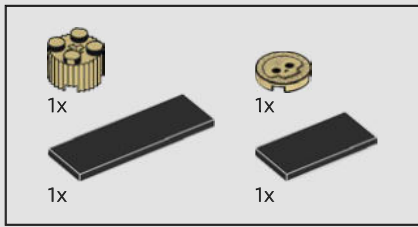

147

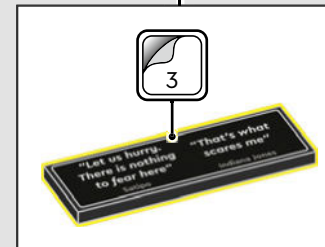
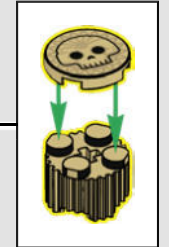
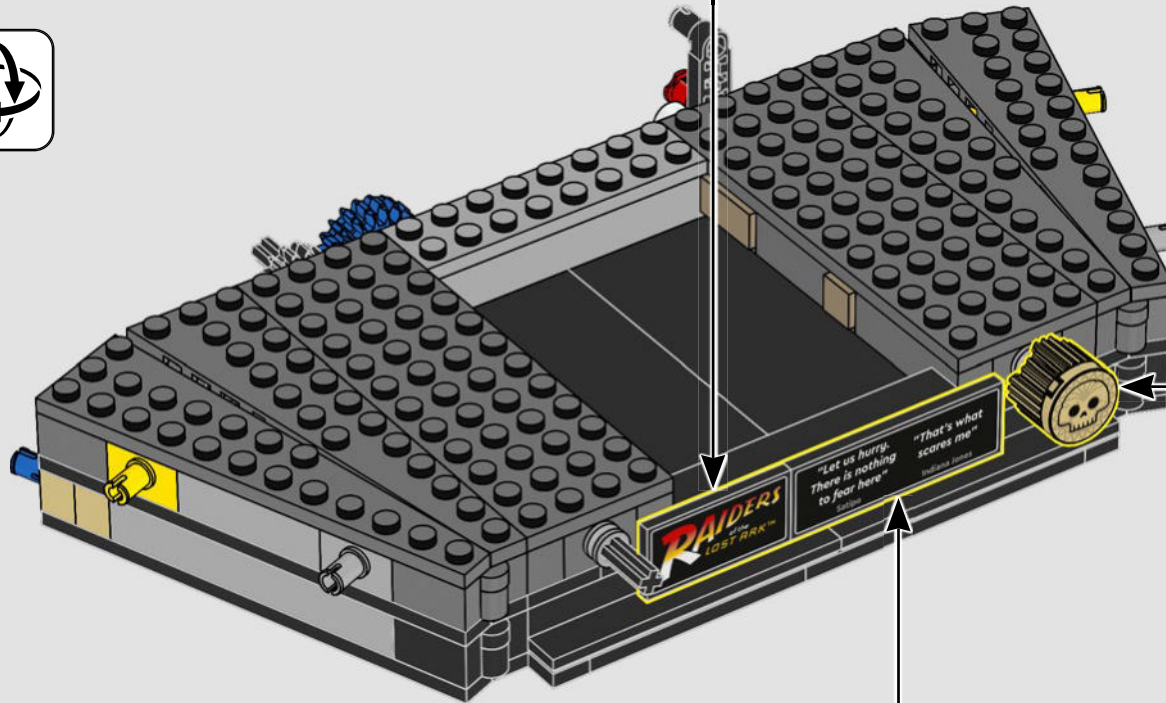
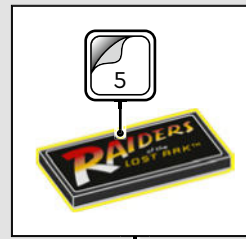

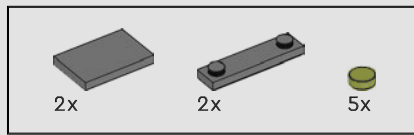

148

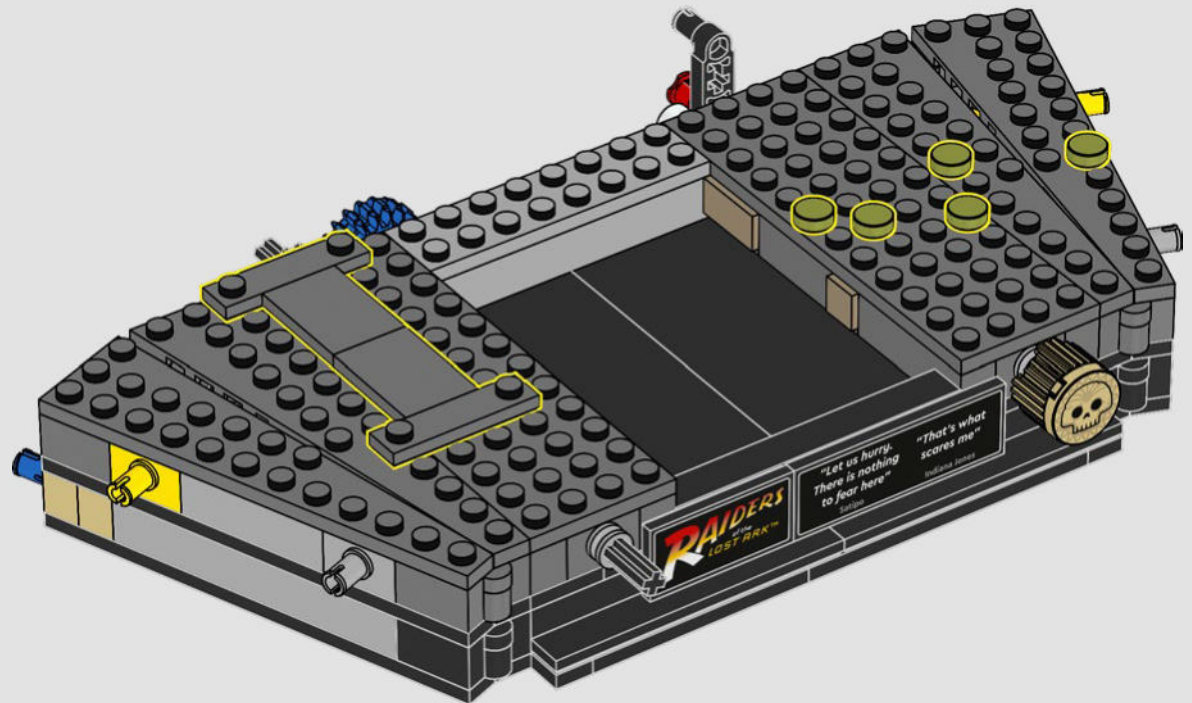

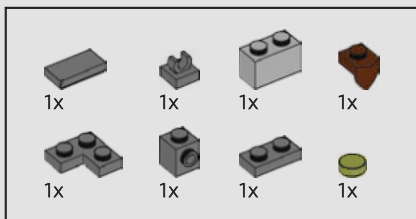

149

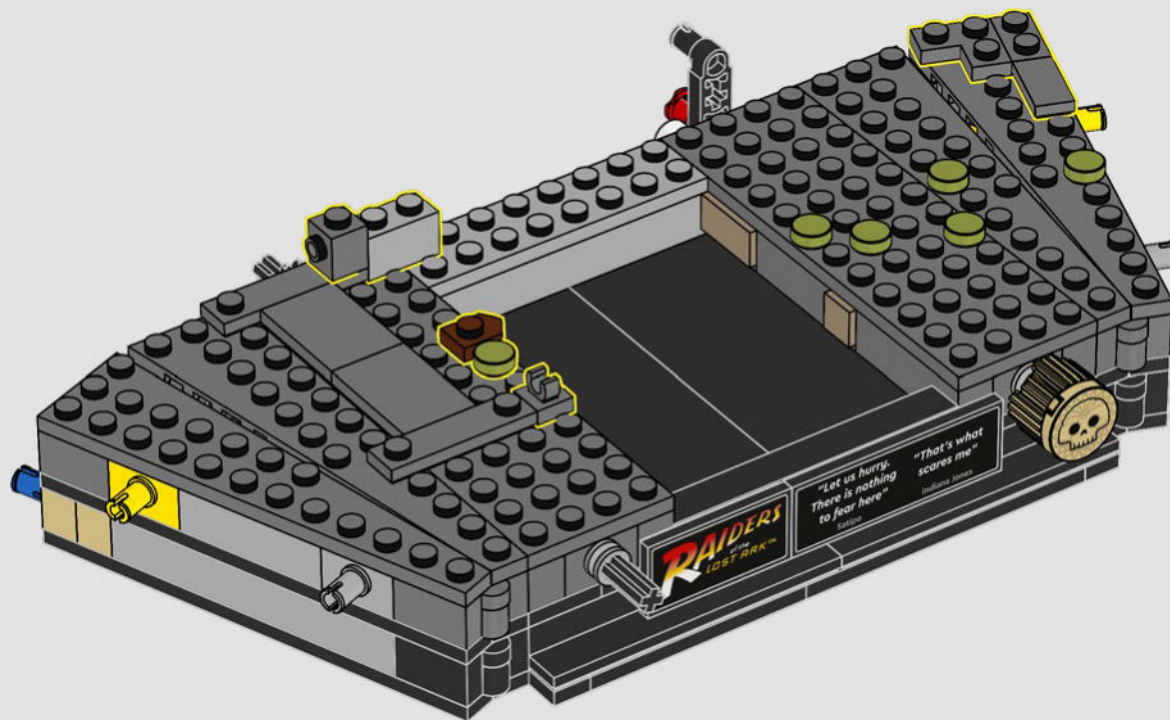

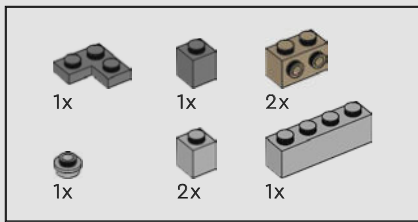

150

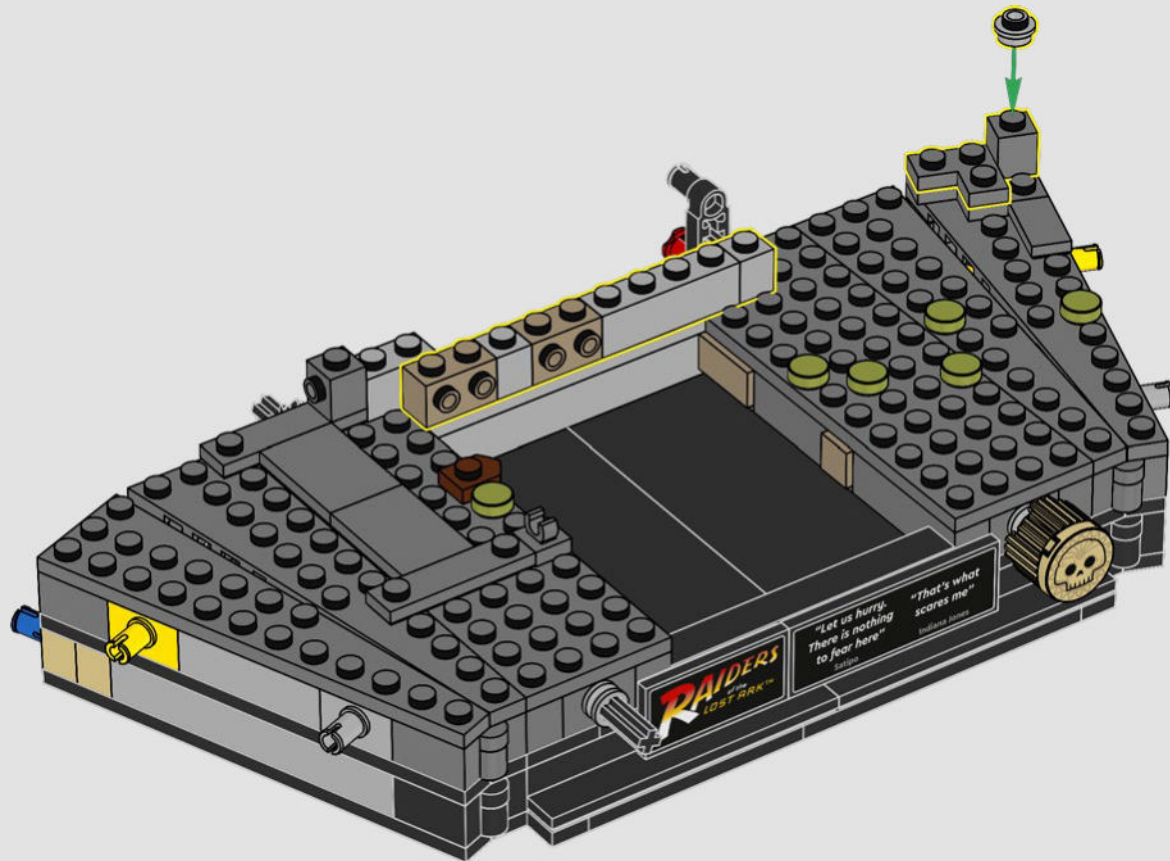

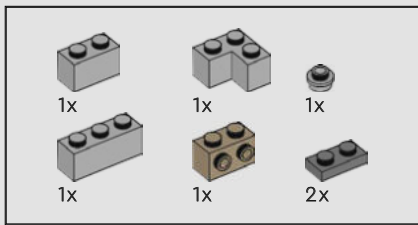

151

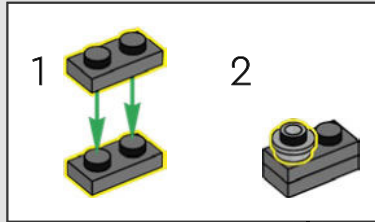

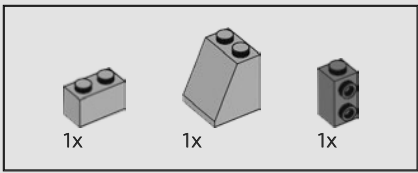

152



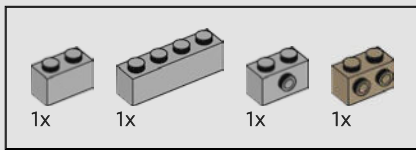

153

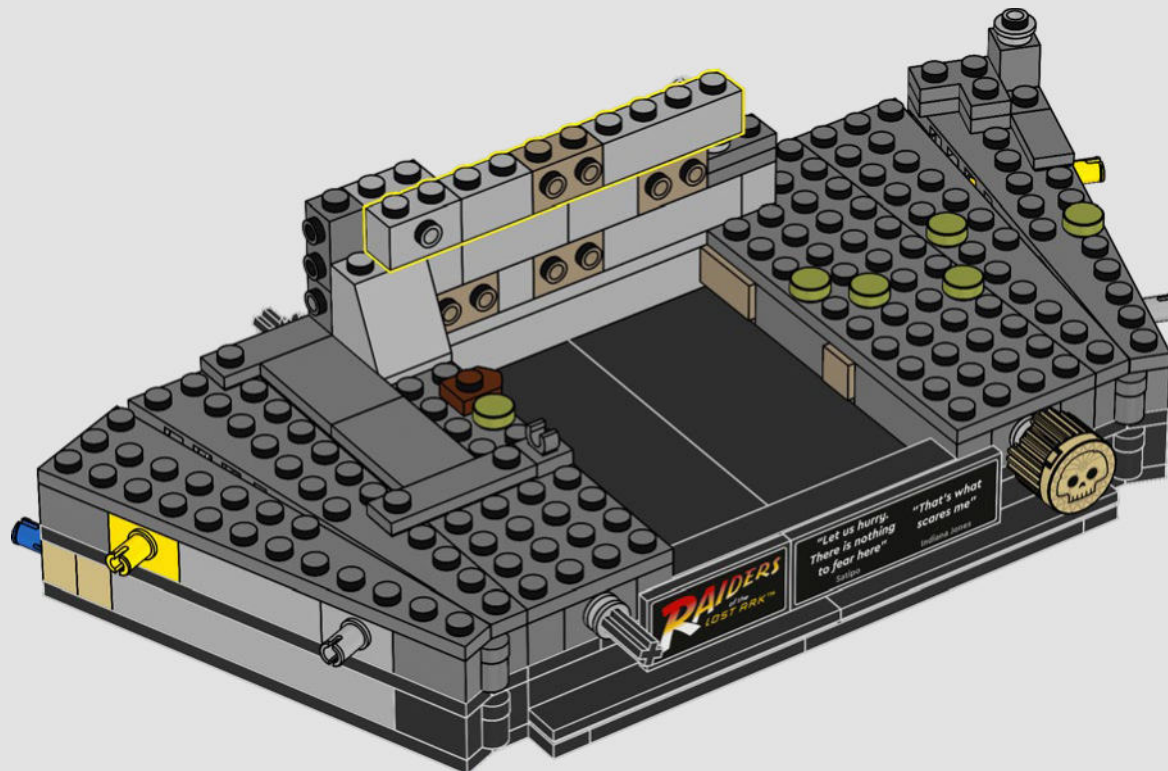

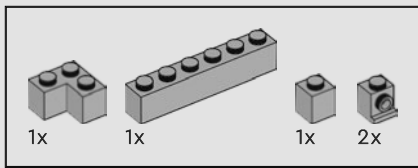

154

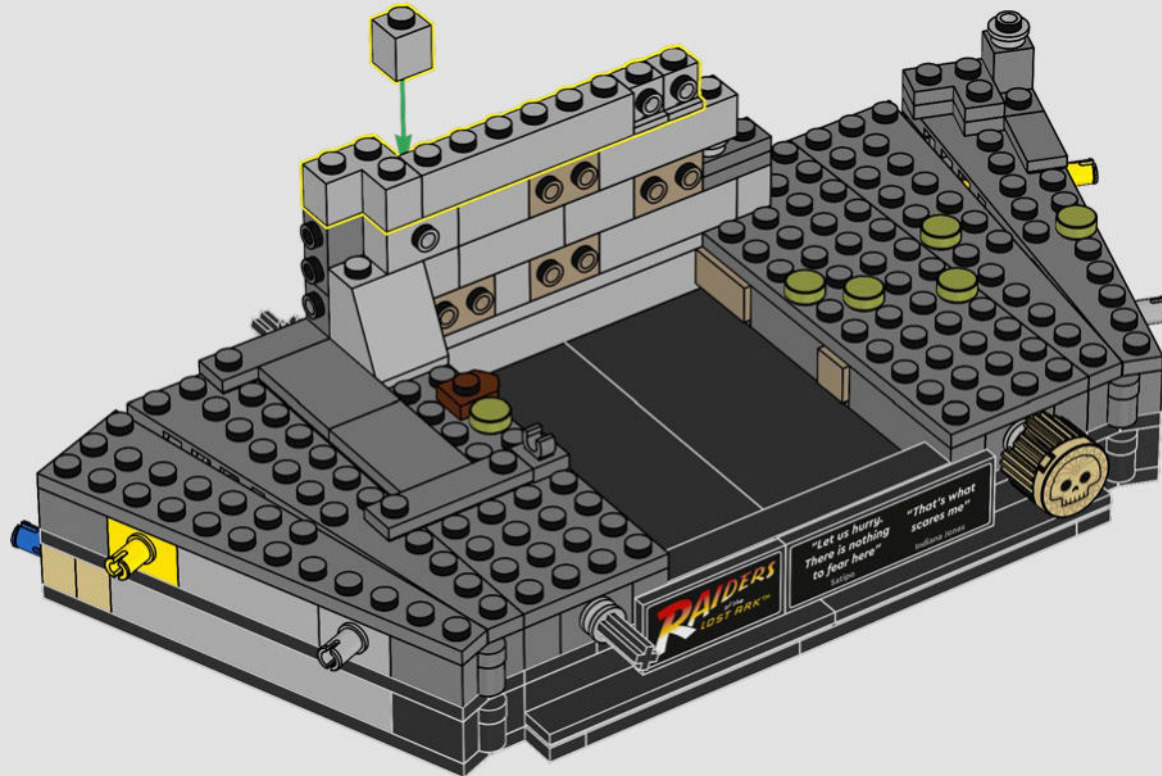

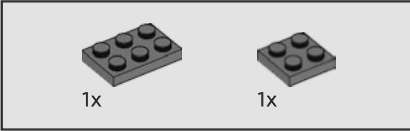
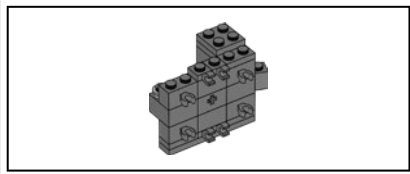

155

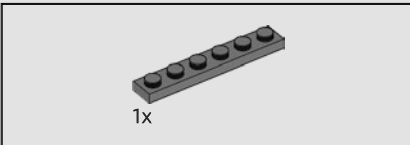
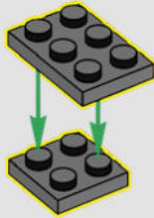

156

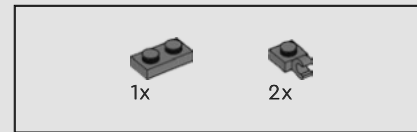
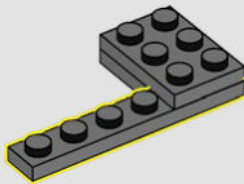

157

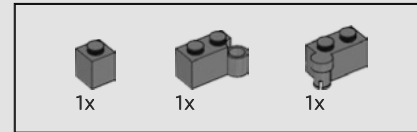
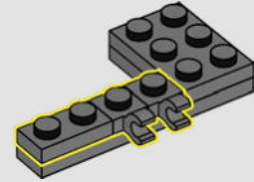

158

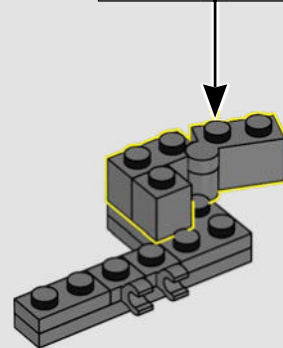
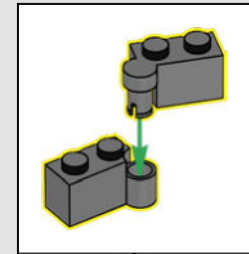

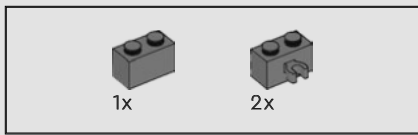

159

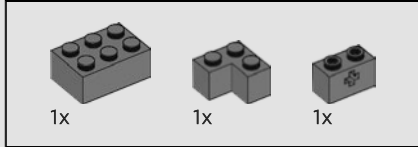
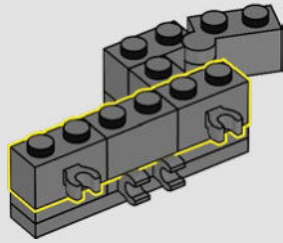

160

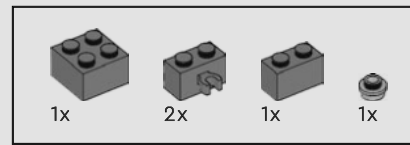
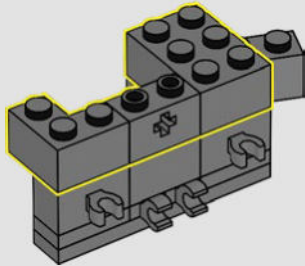

161

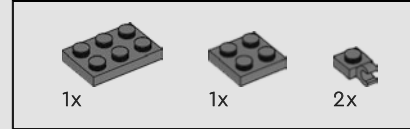
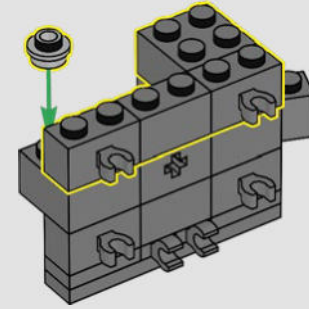

162

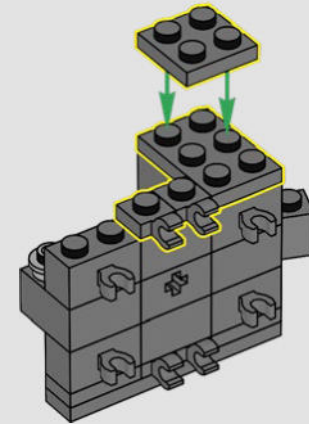

163

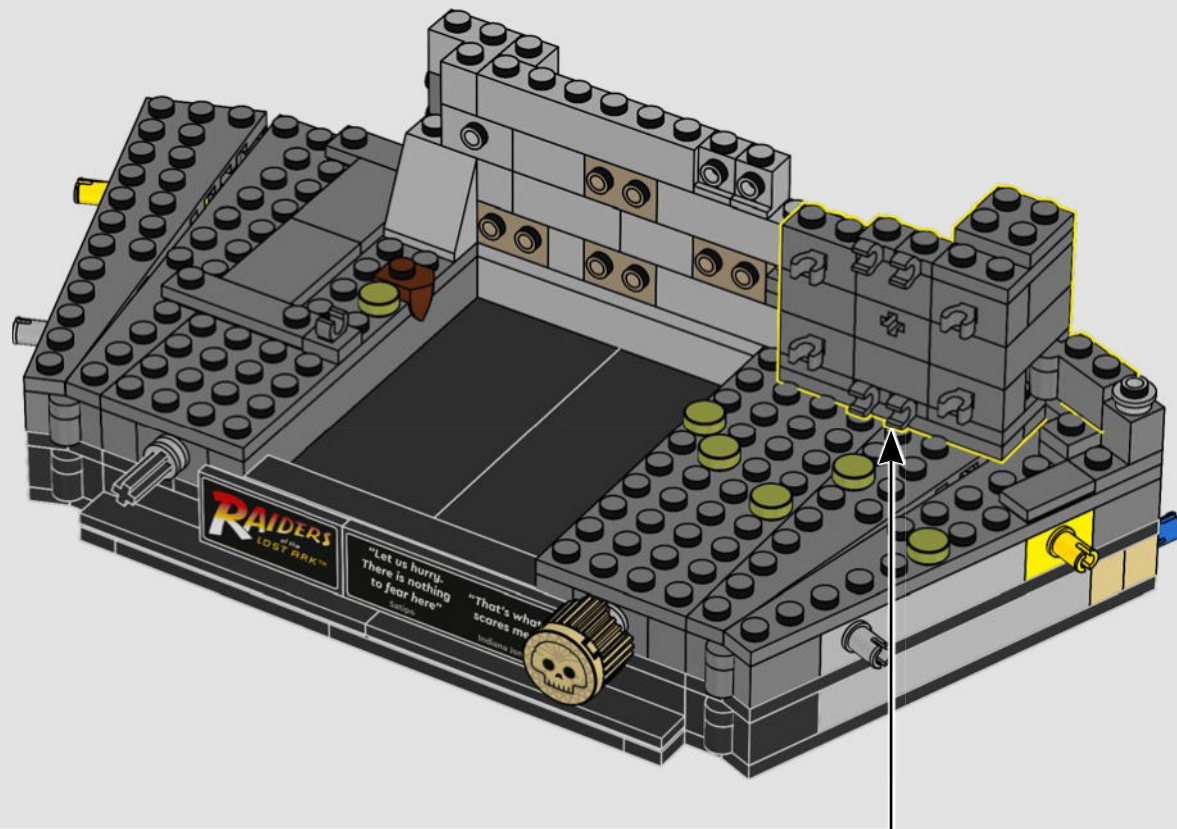

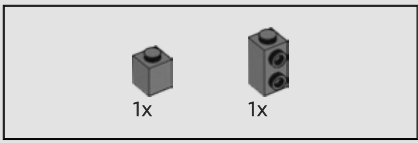

164

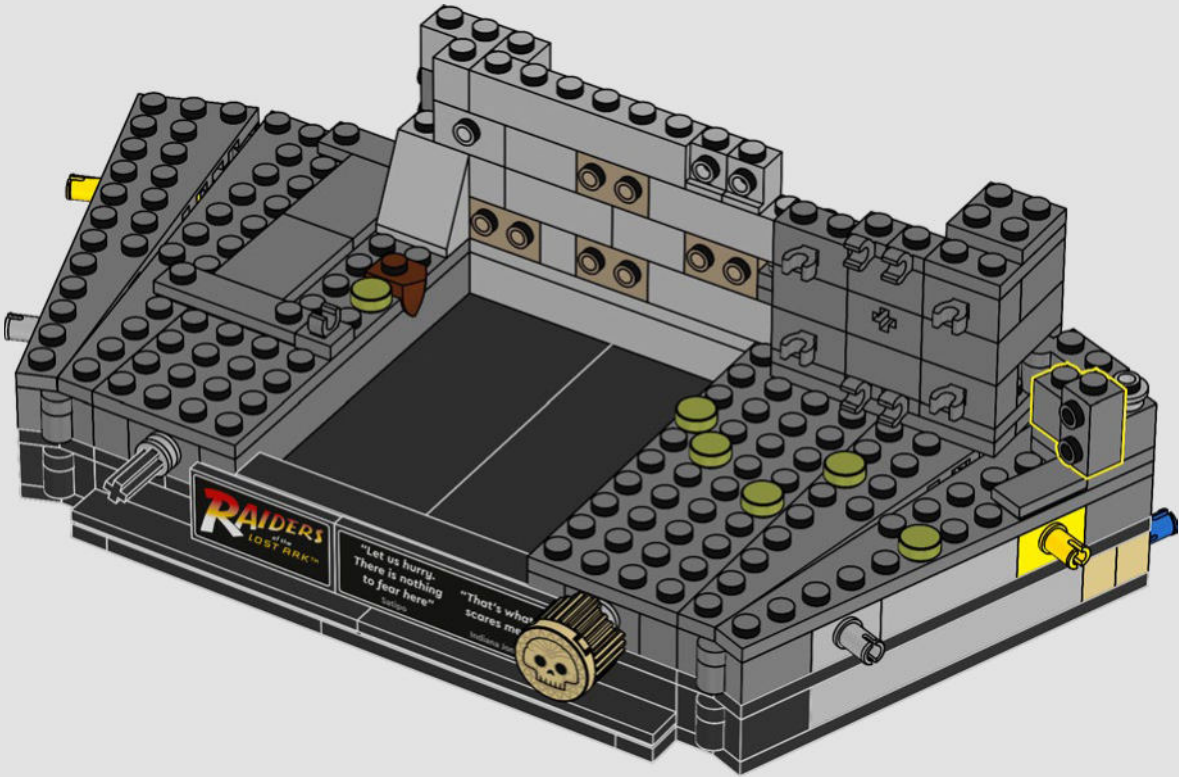

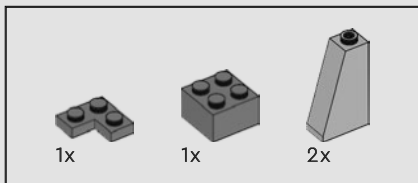

165

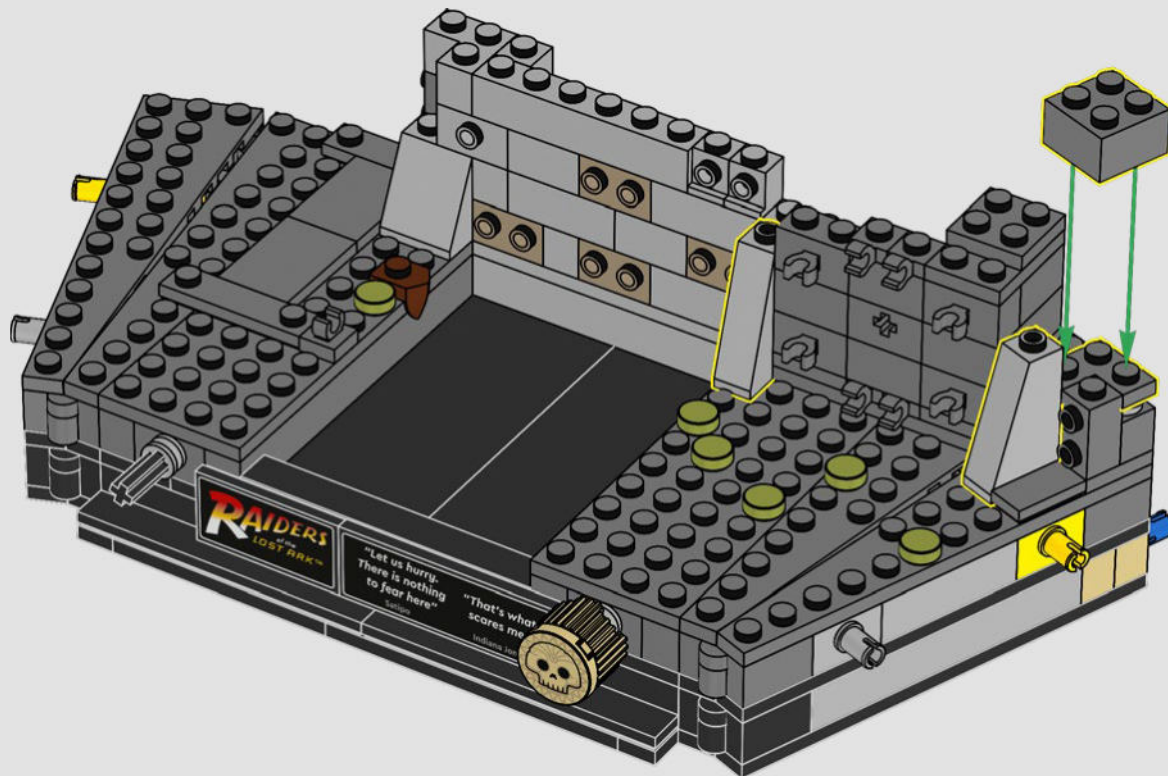

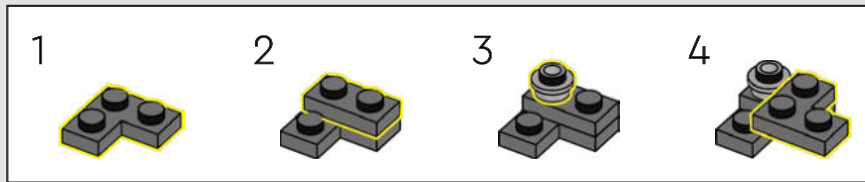
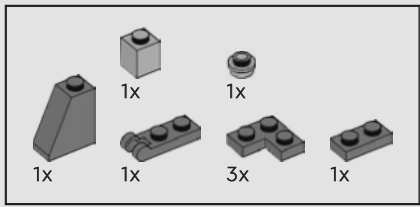

166

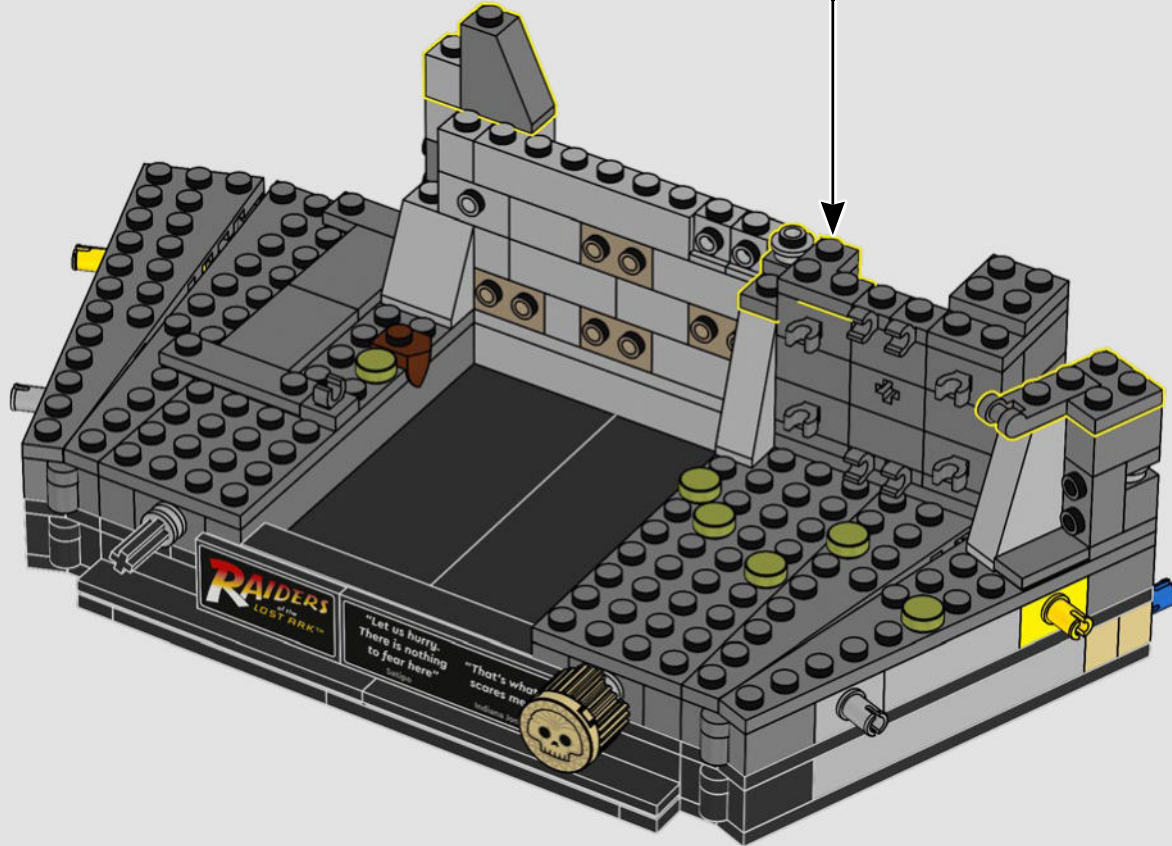

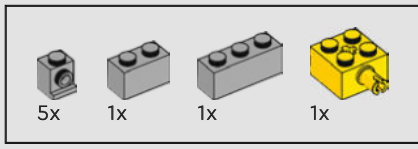

167

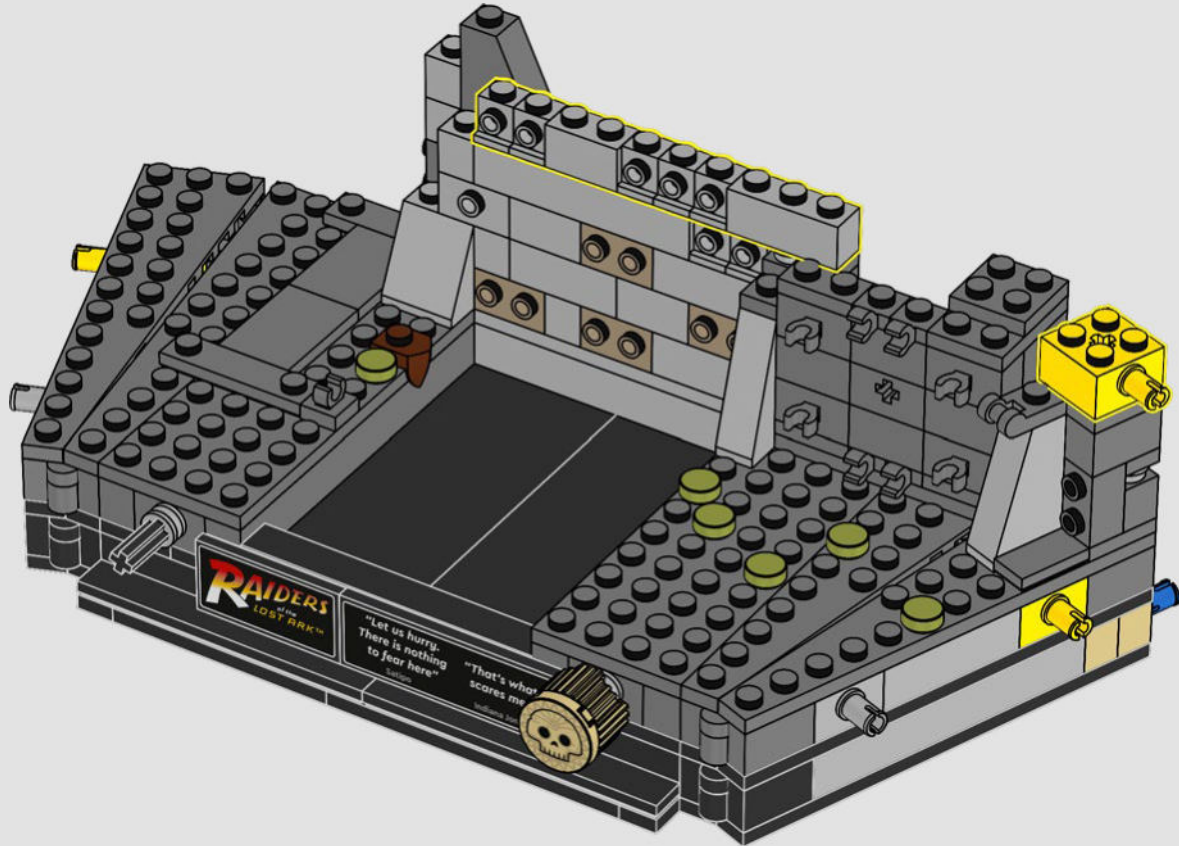

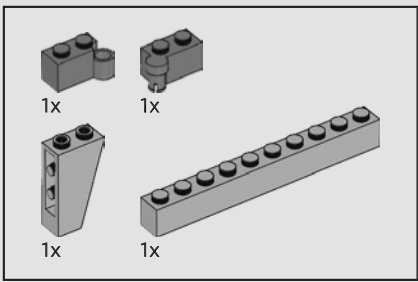

168

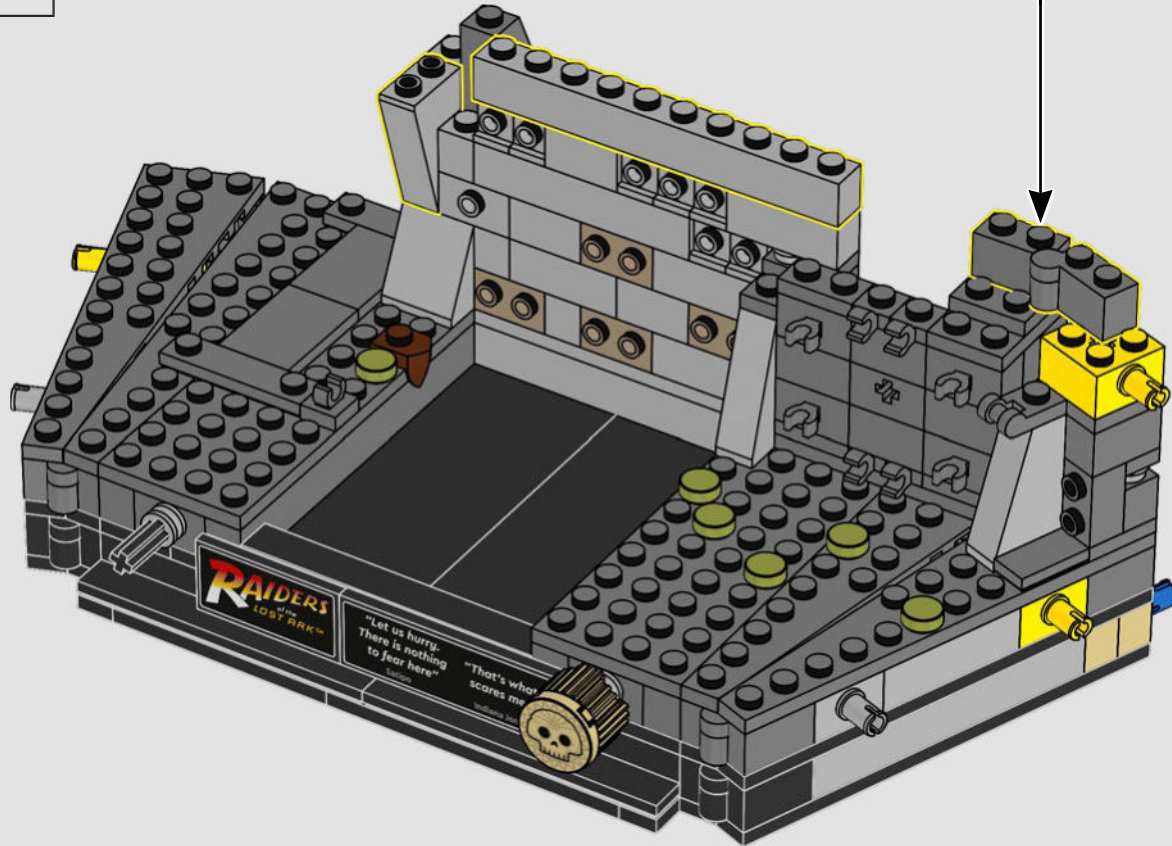
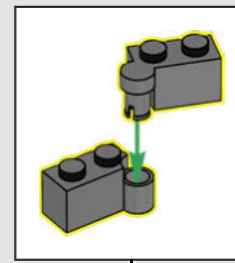

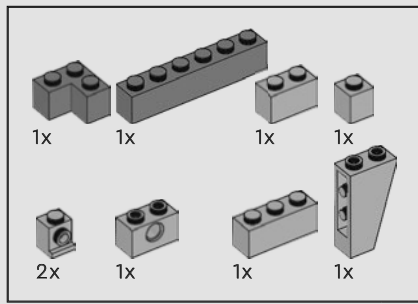

169

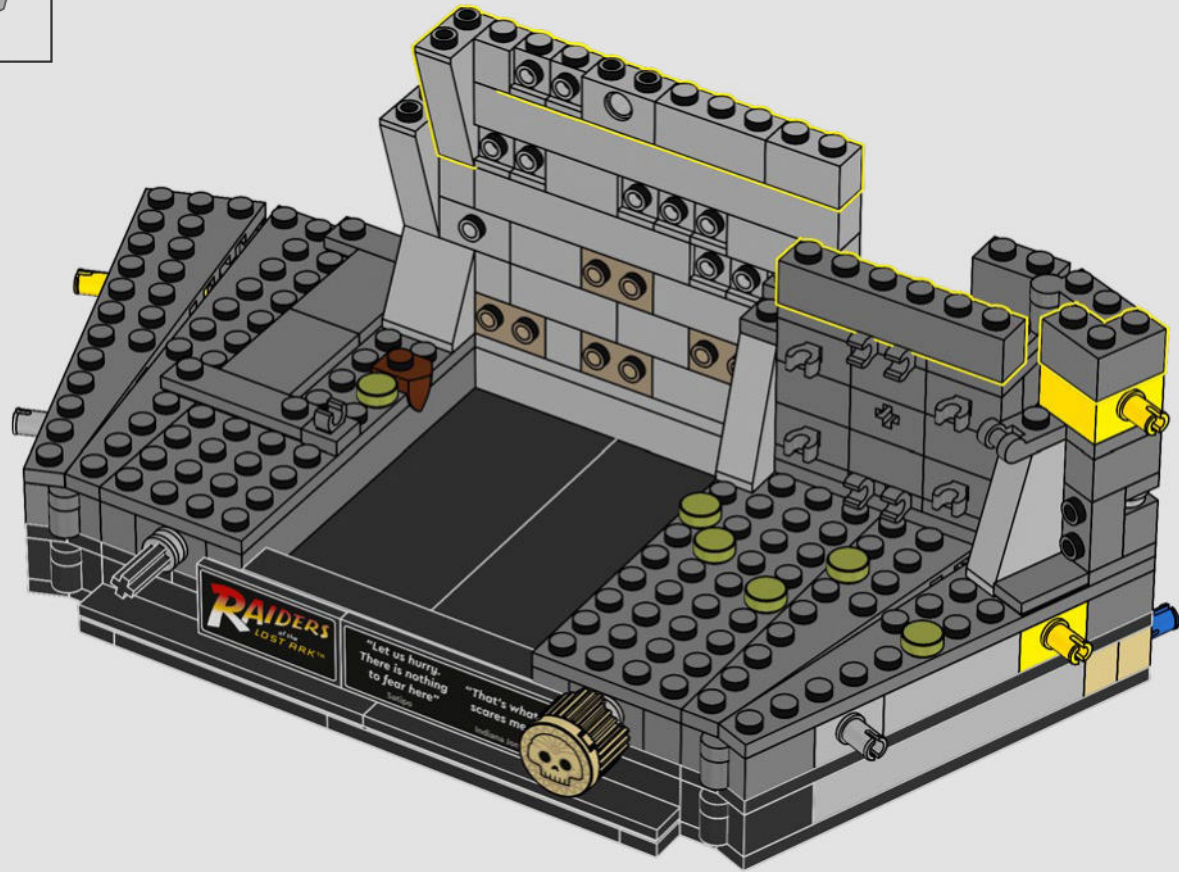

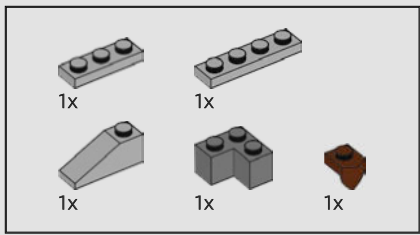

170

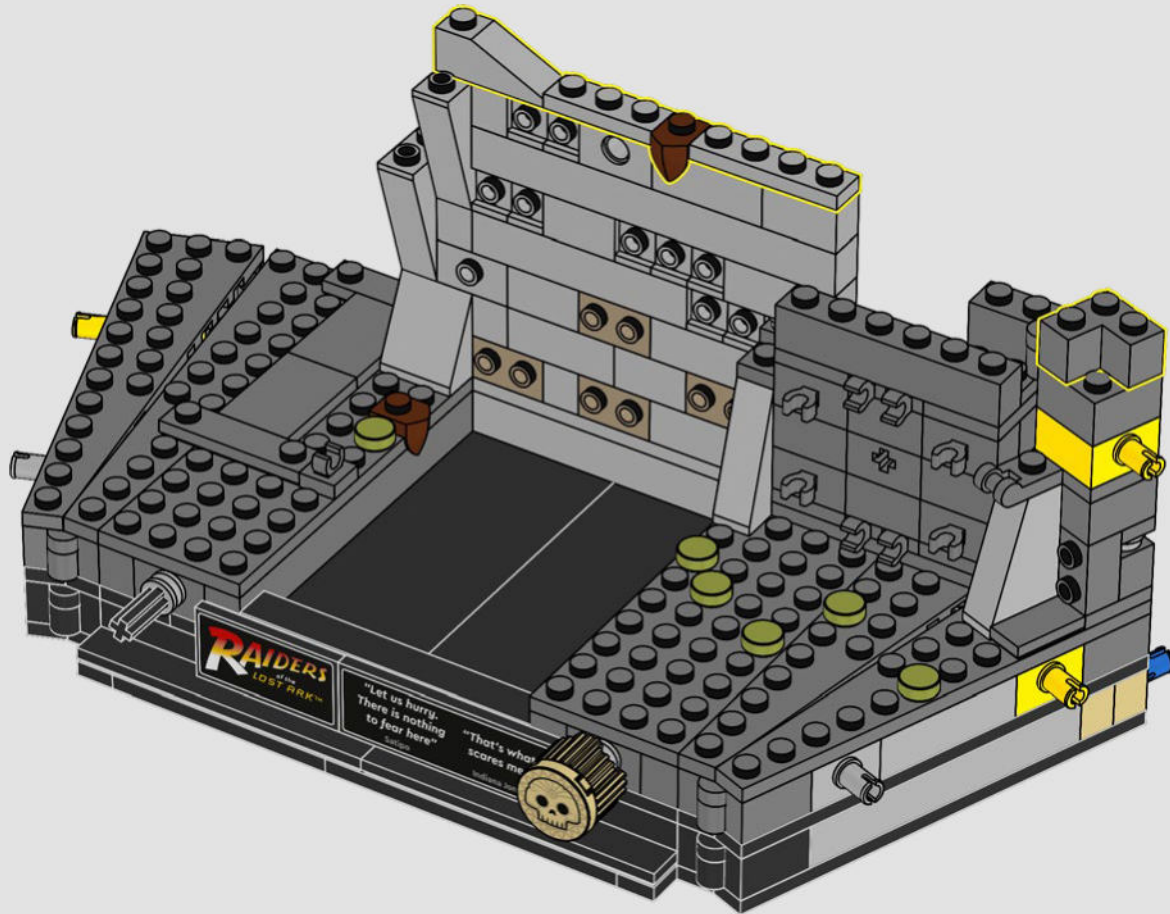

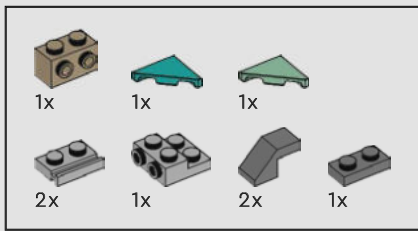

171

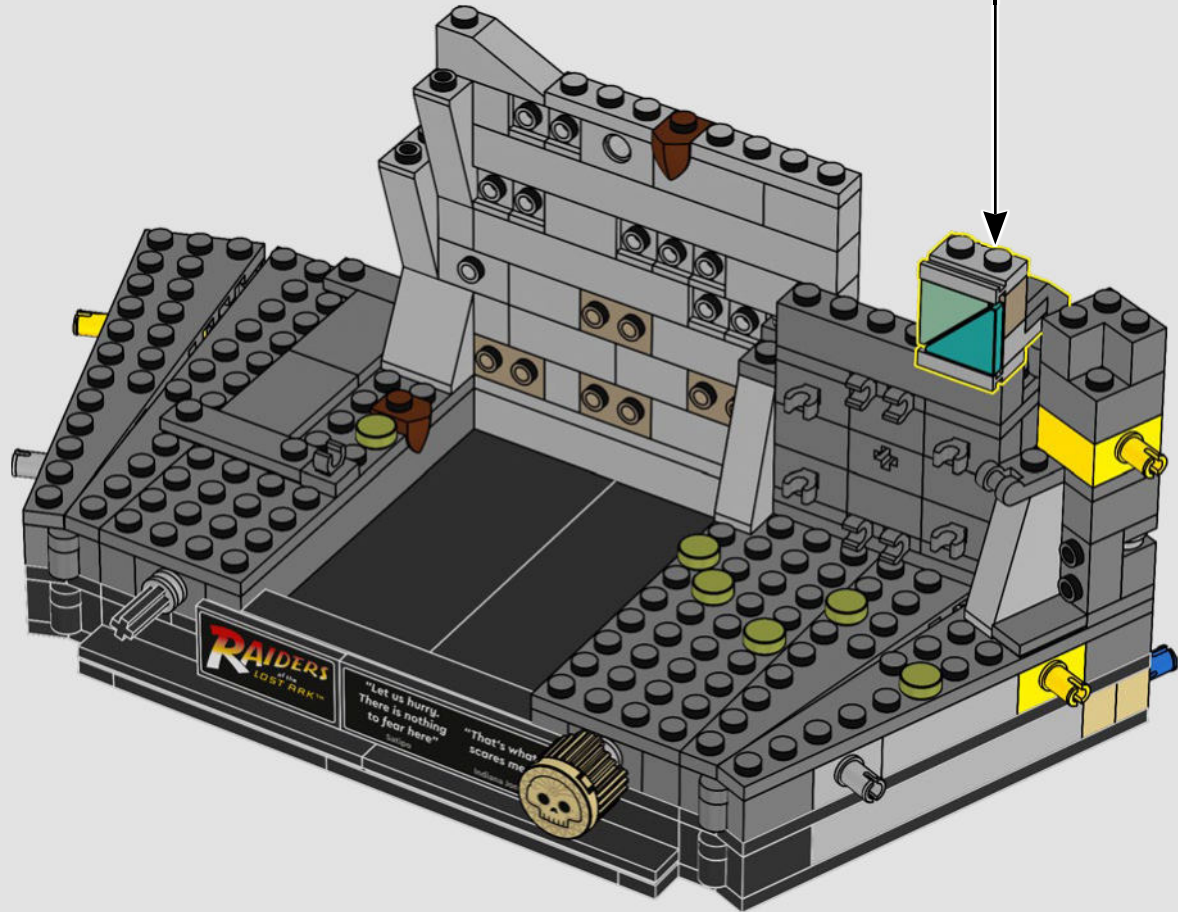
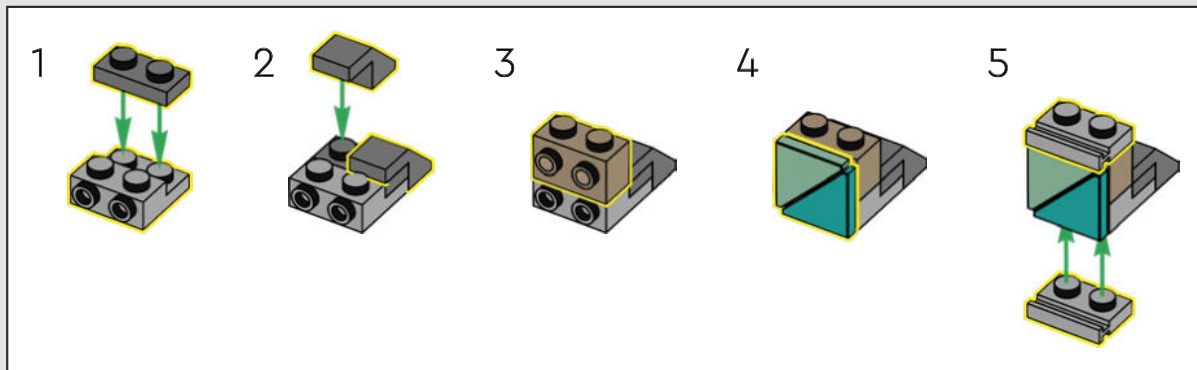

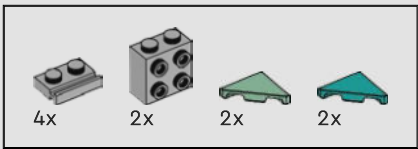

172

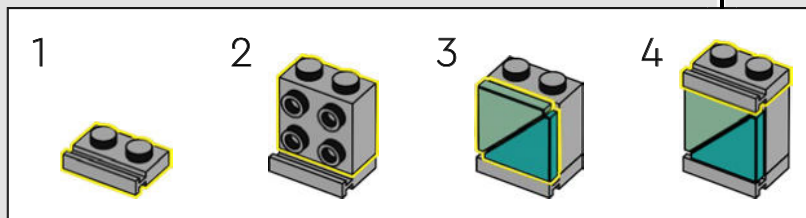
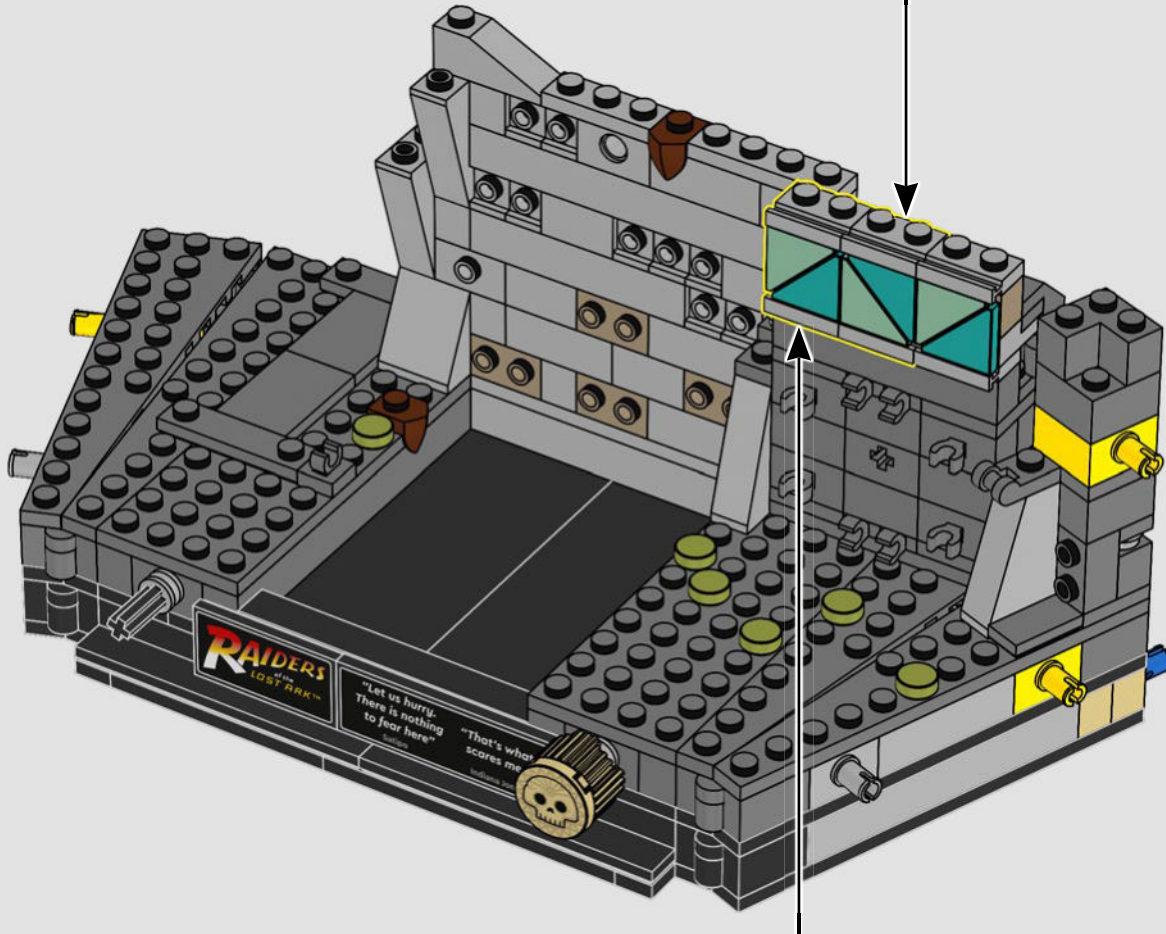
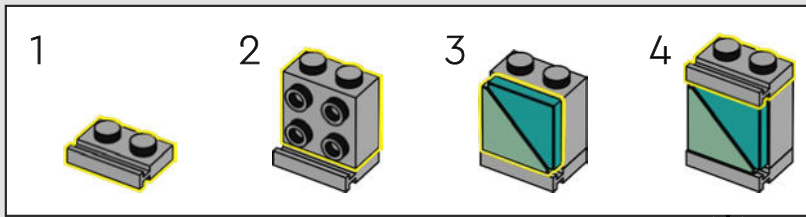

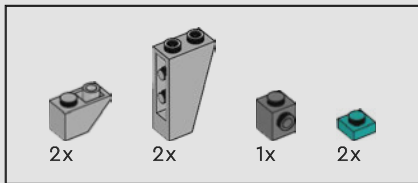

173

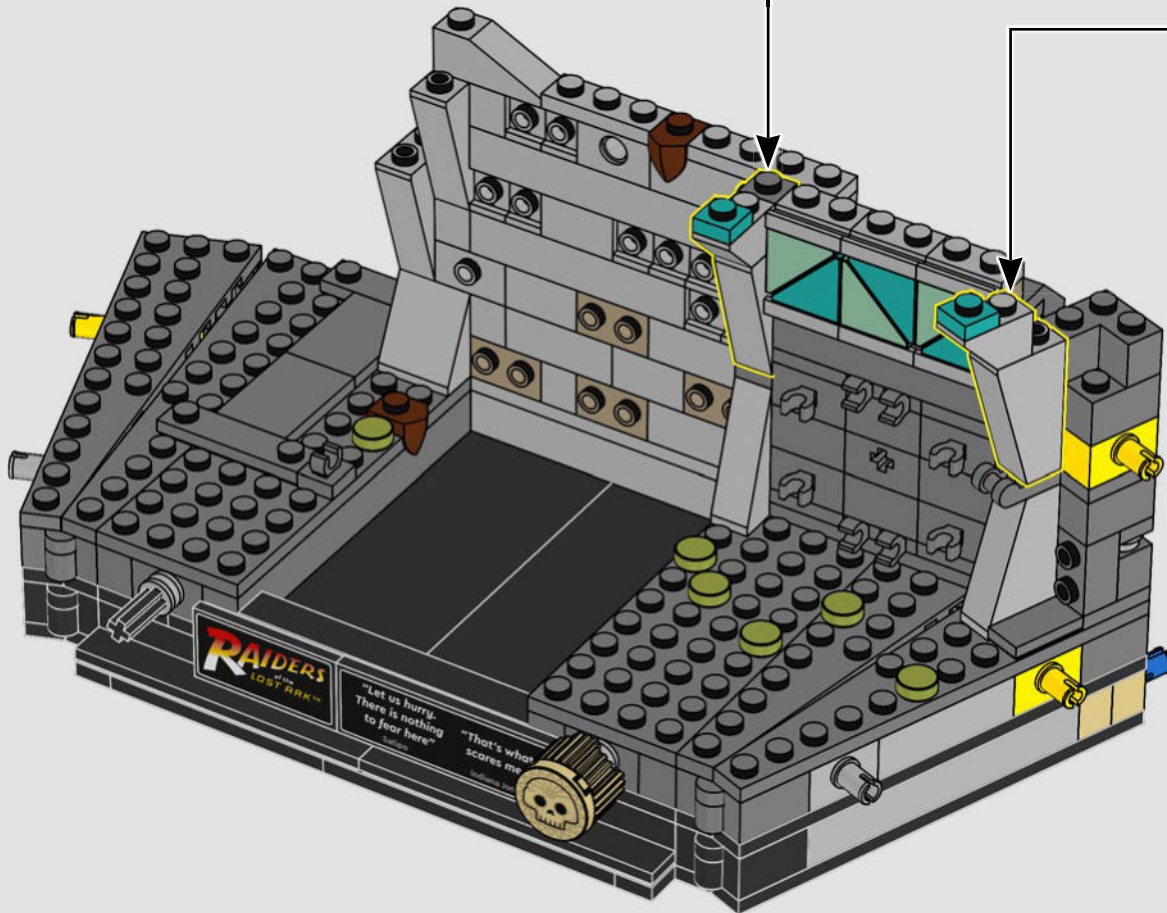
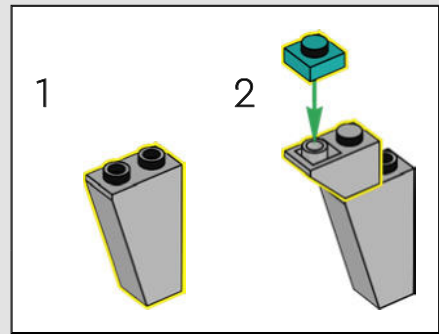
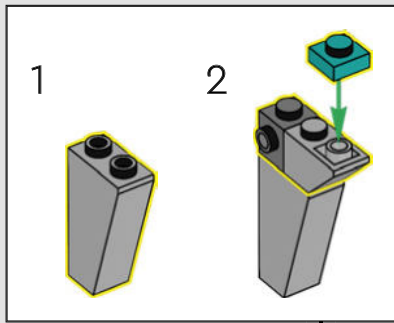



1x

174

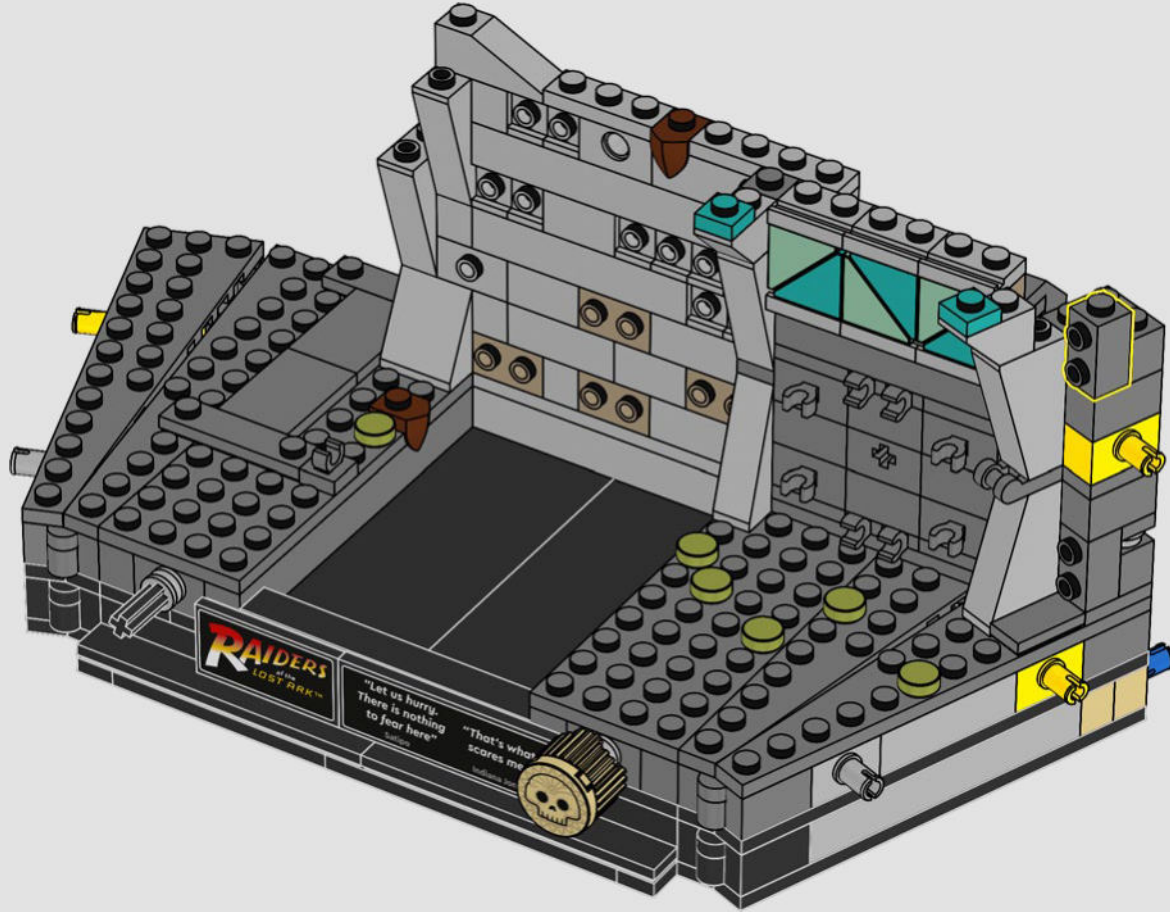

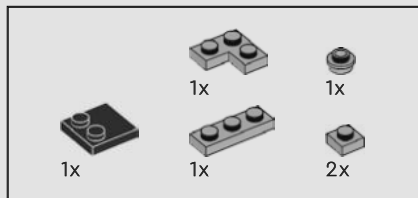

175

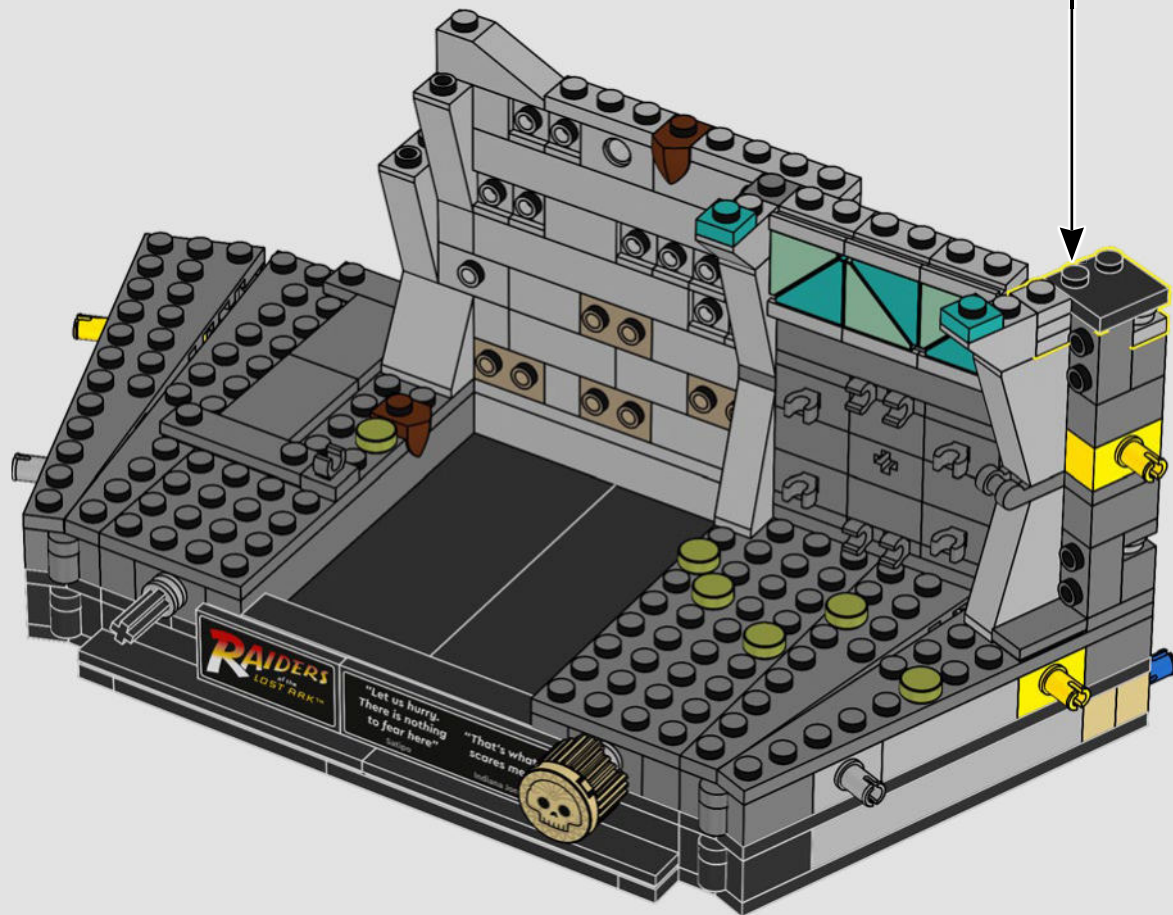
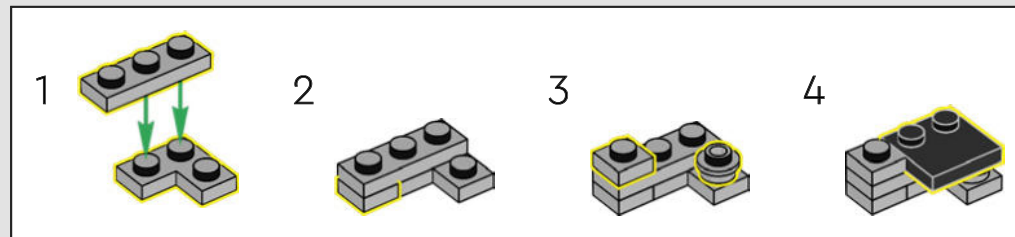



3x

176

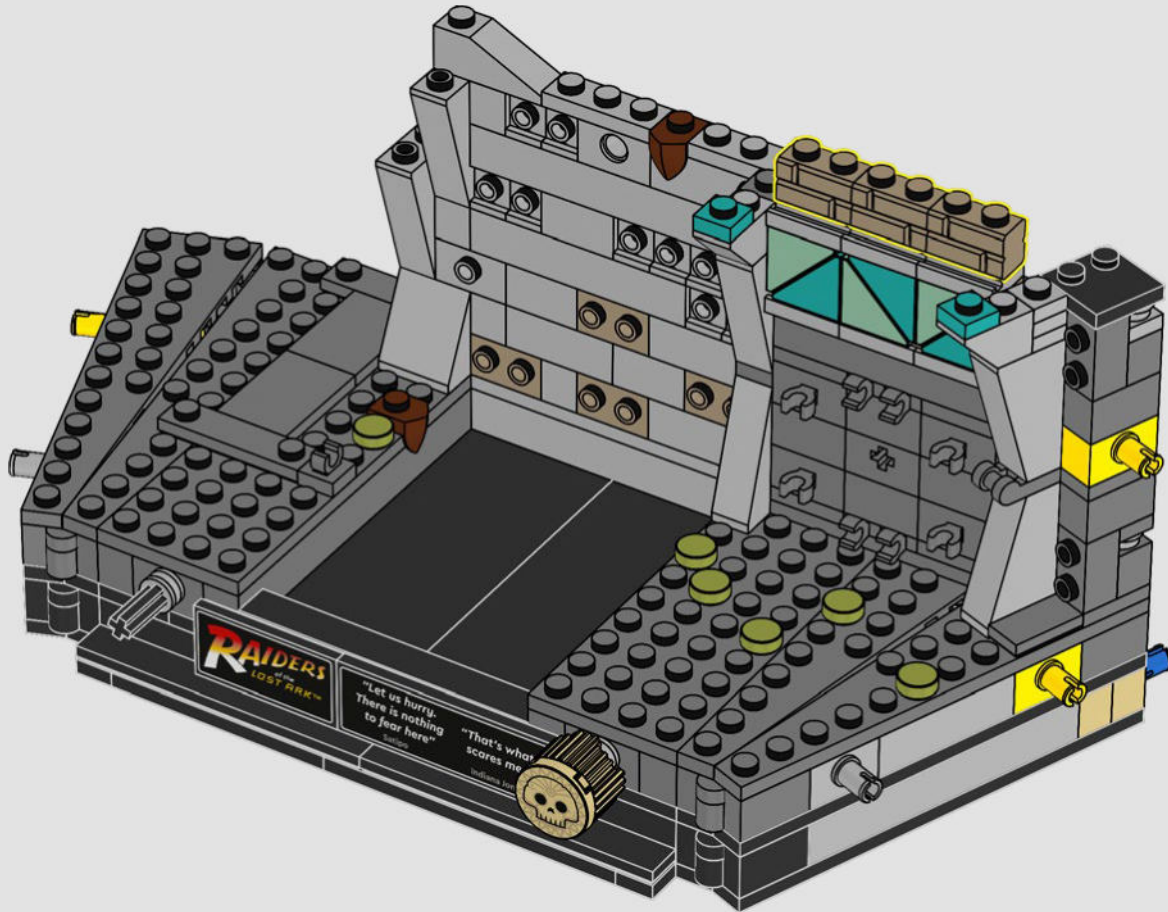

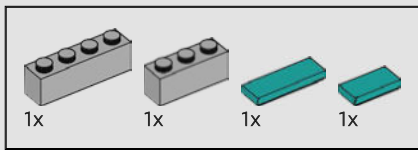

177

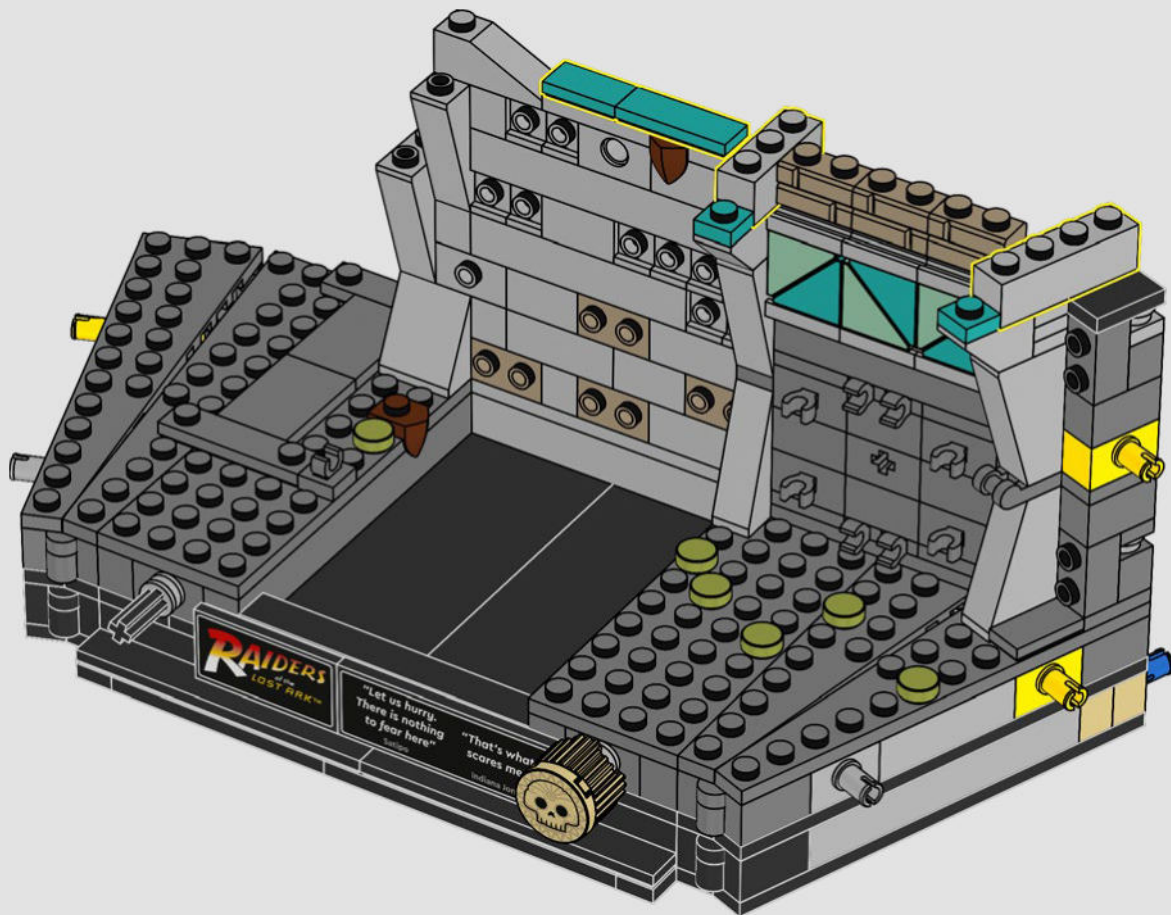

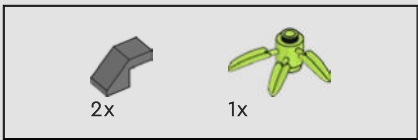

178

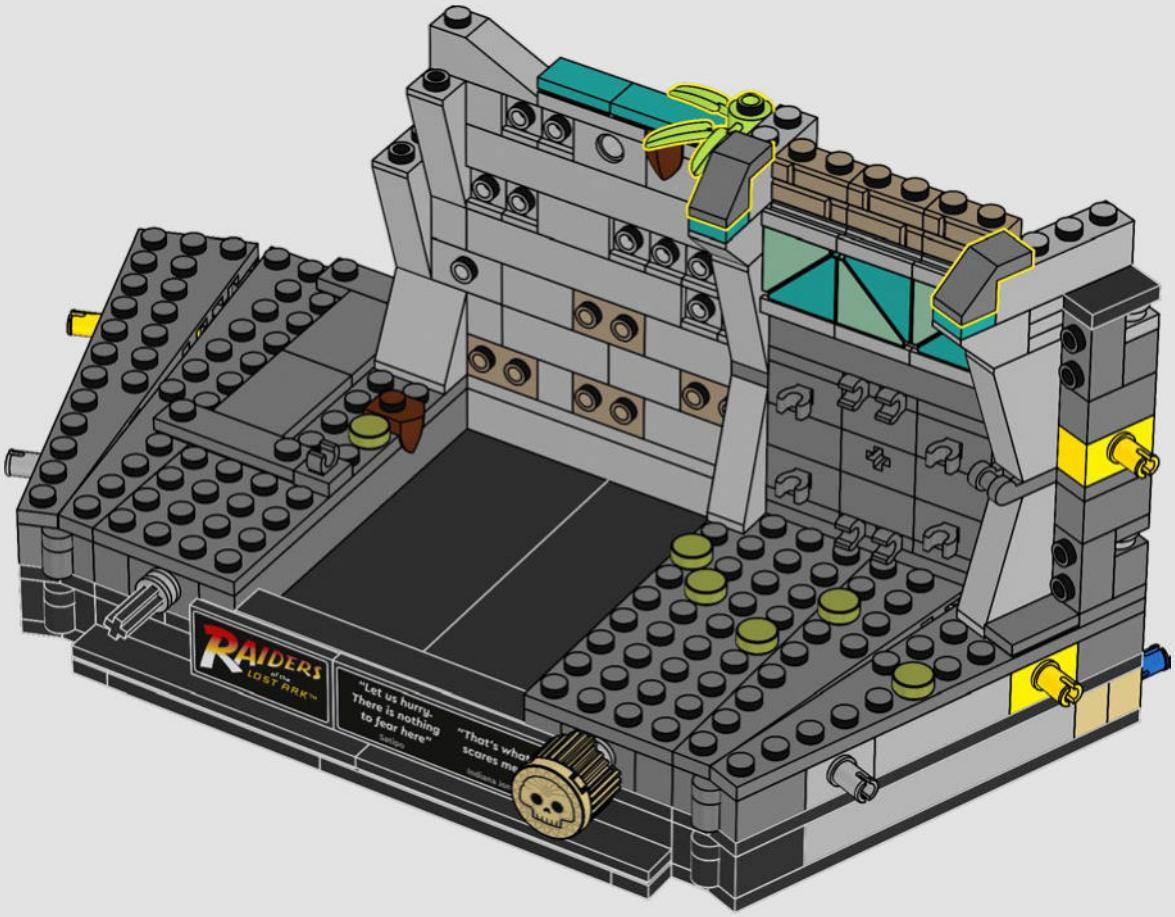

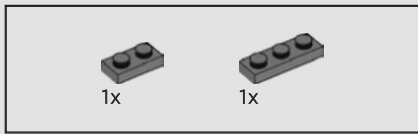

179

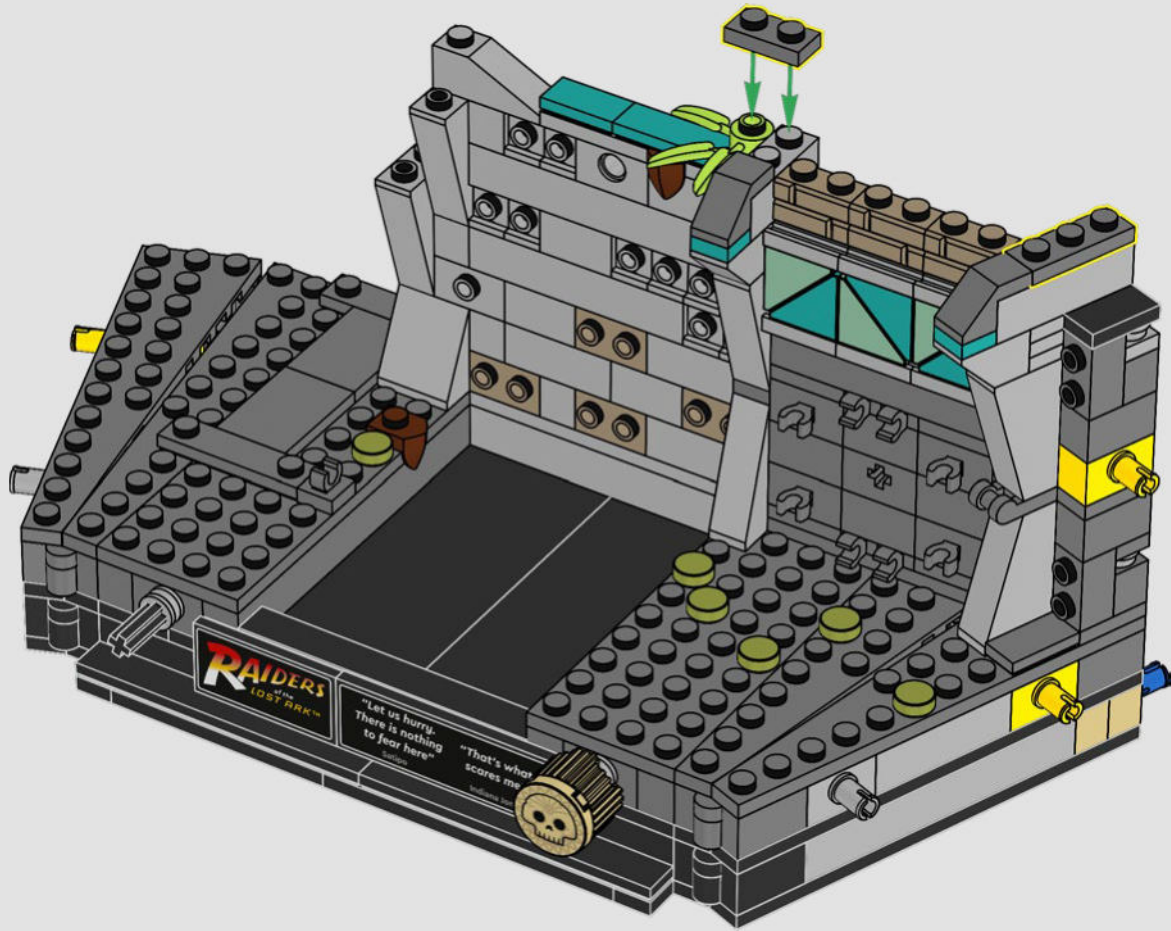

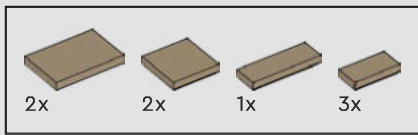

180

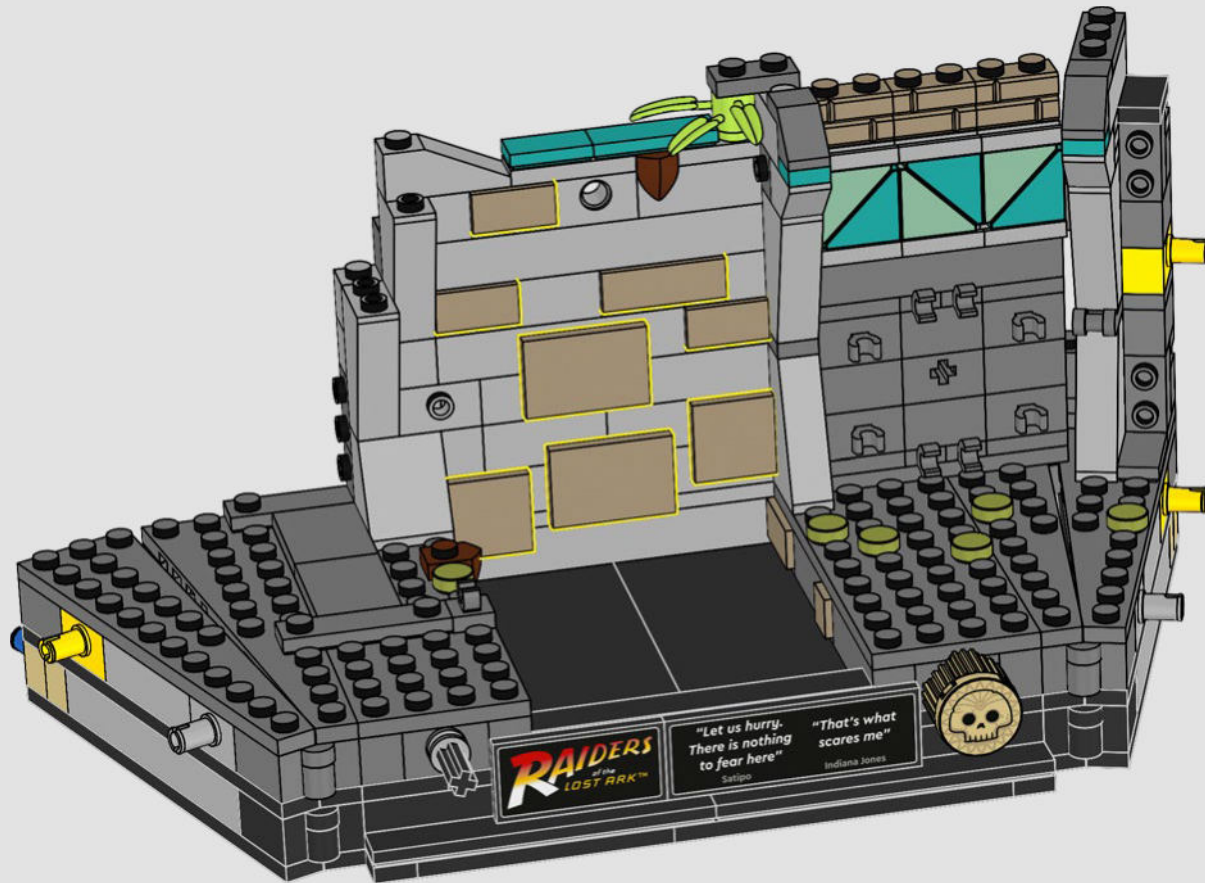

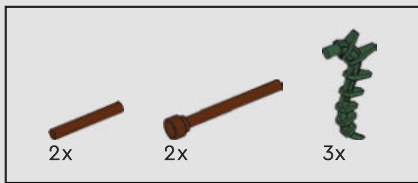

181

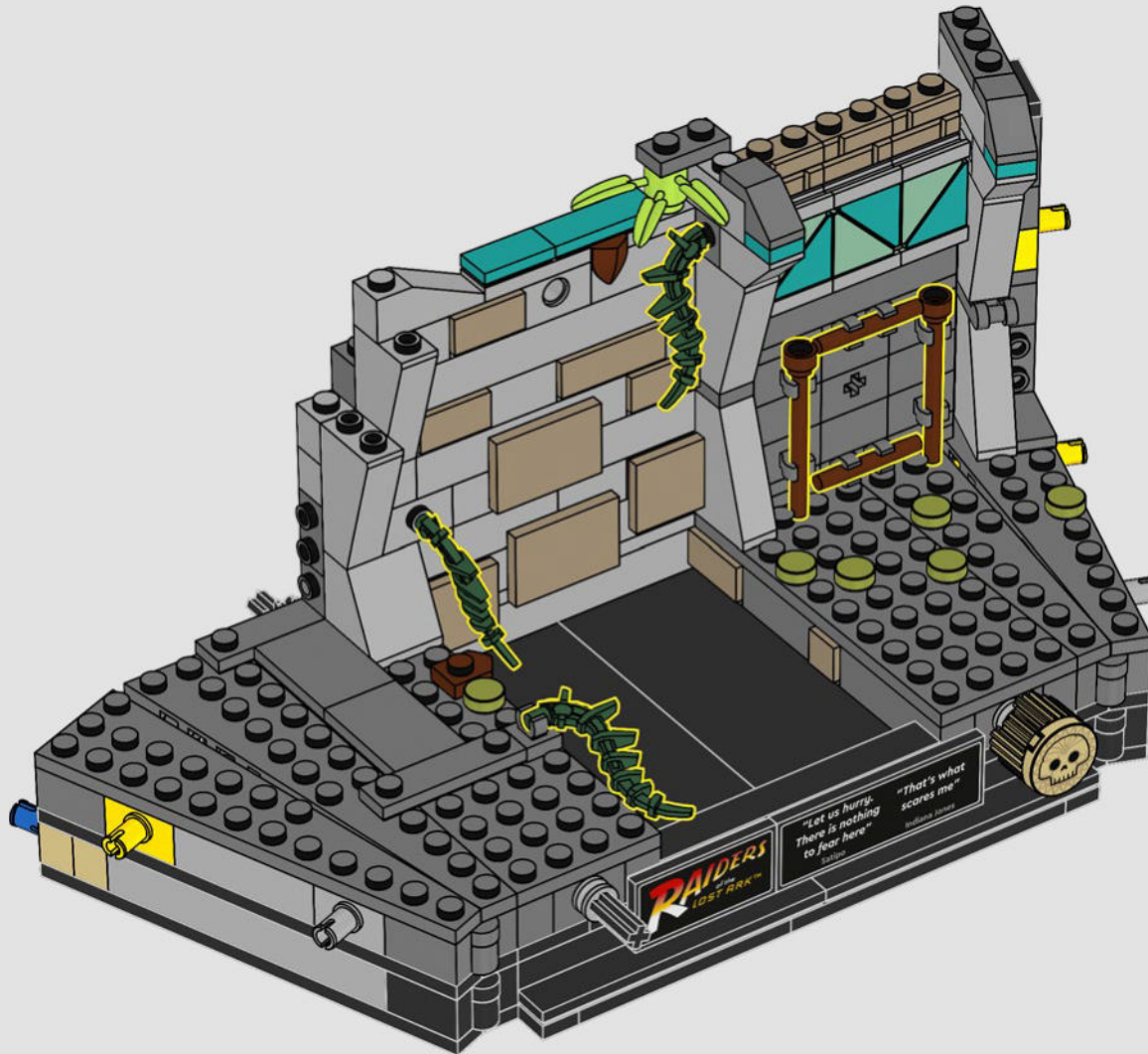

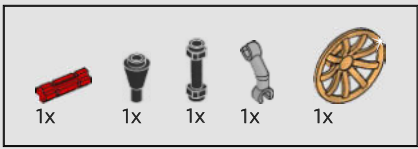

182

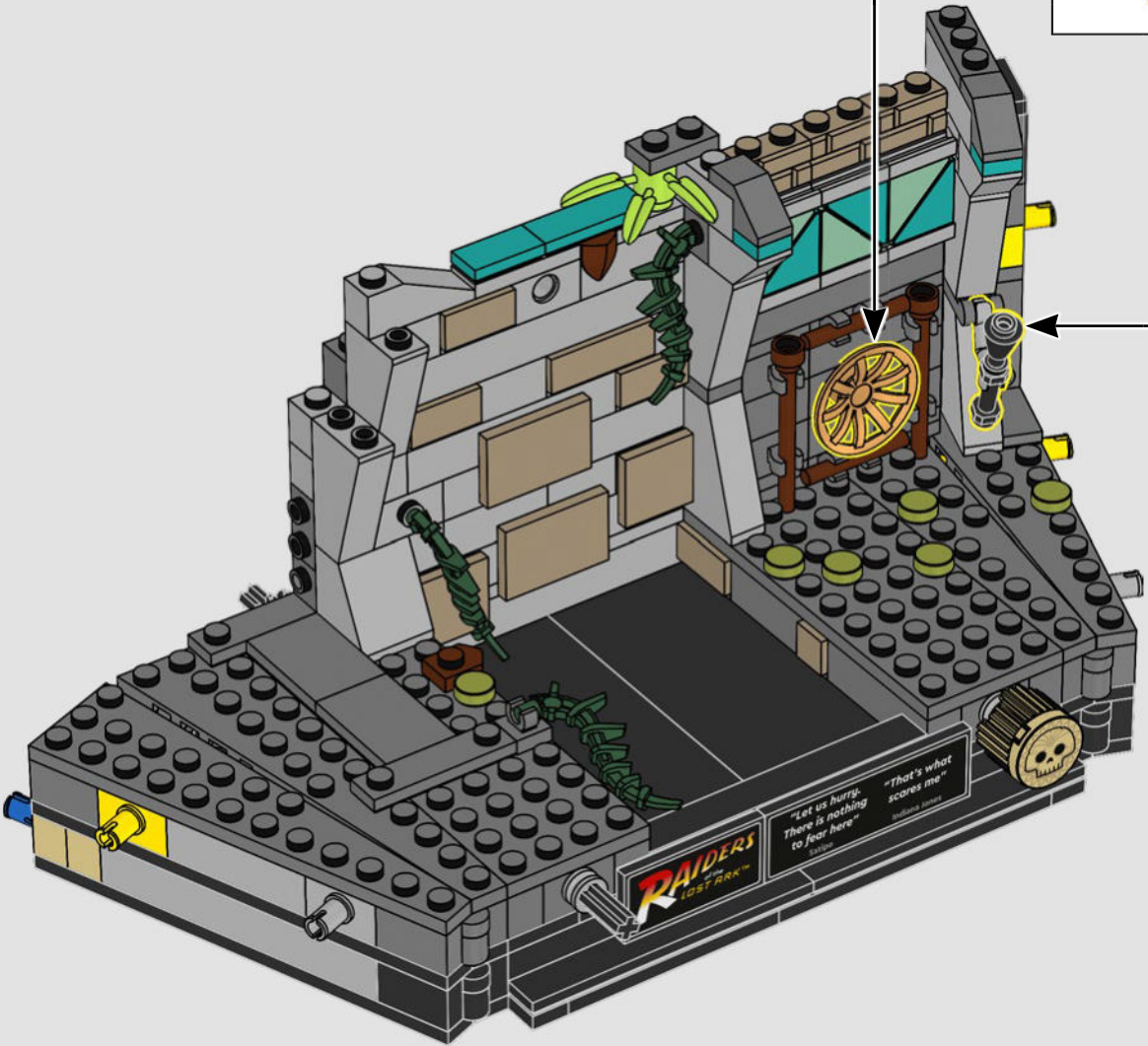
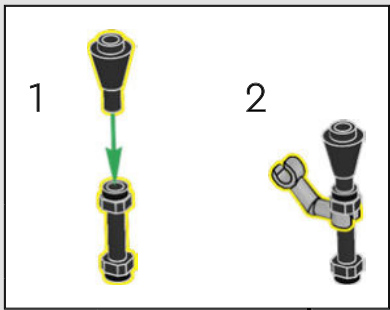
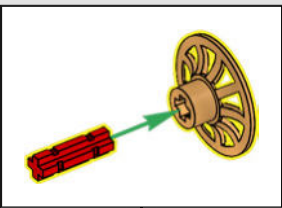

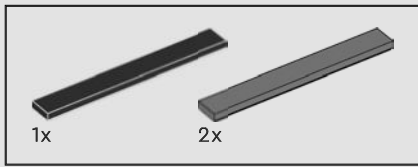

183

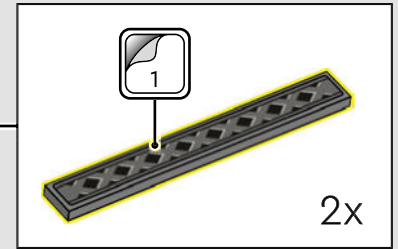
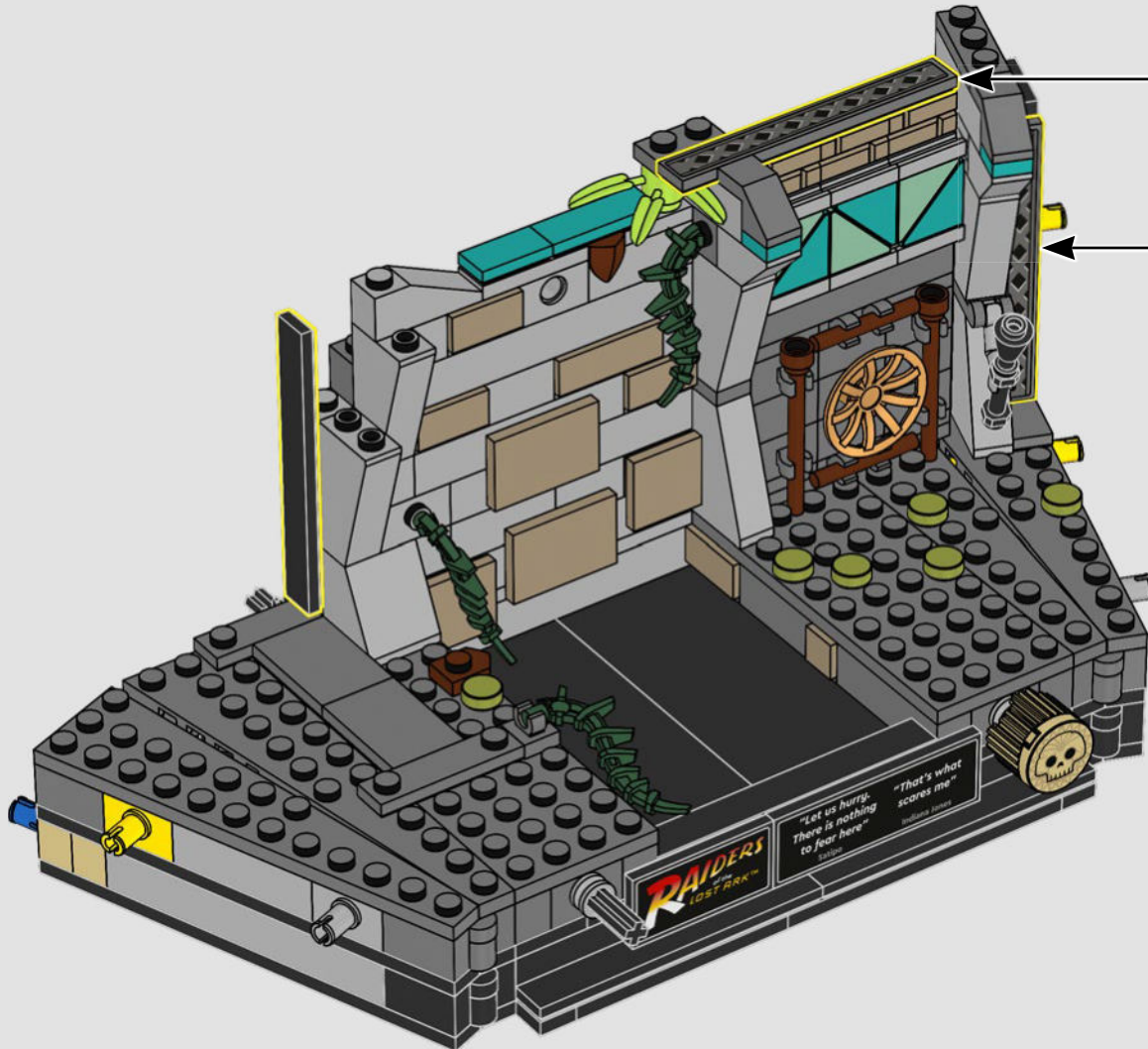



184

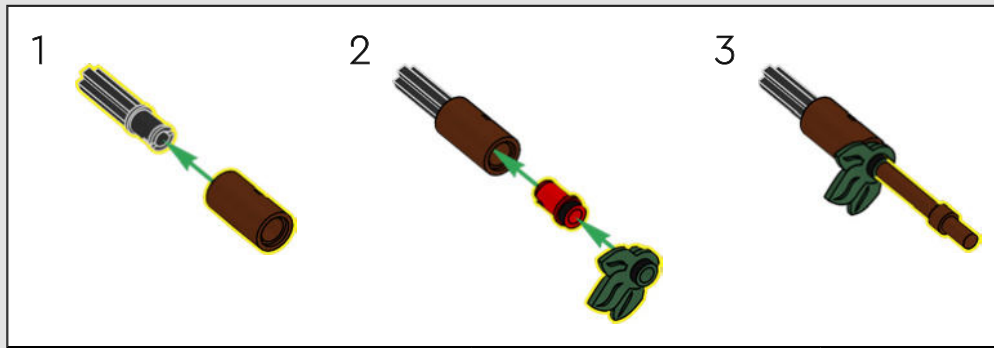

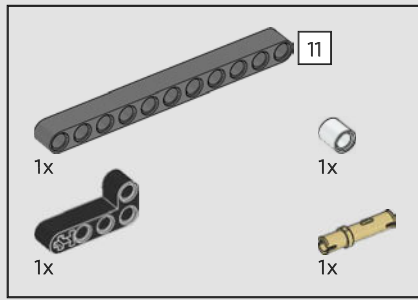

185

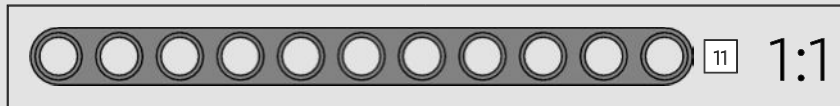
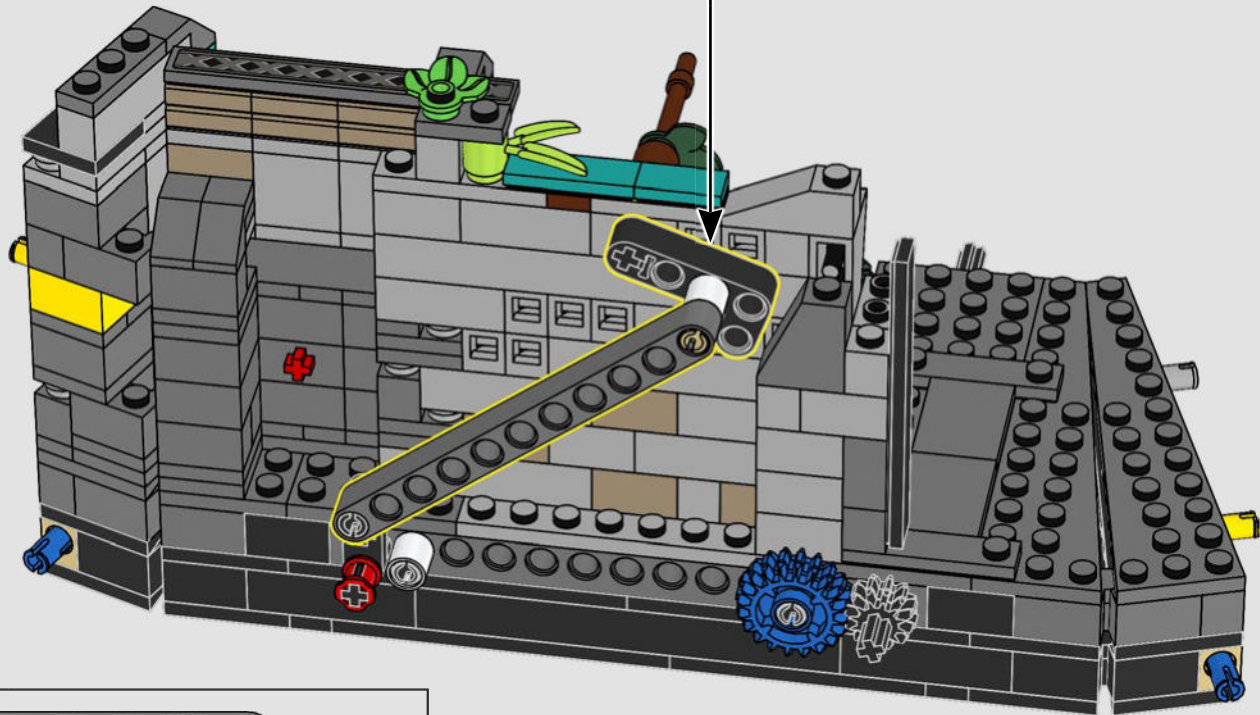
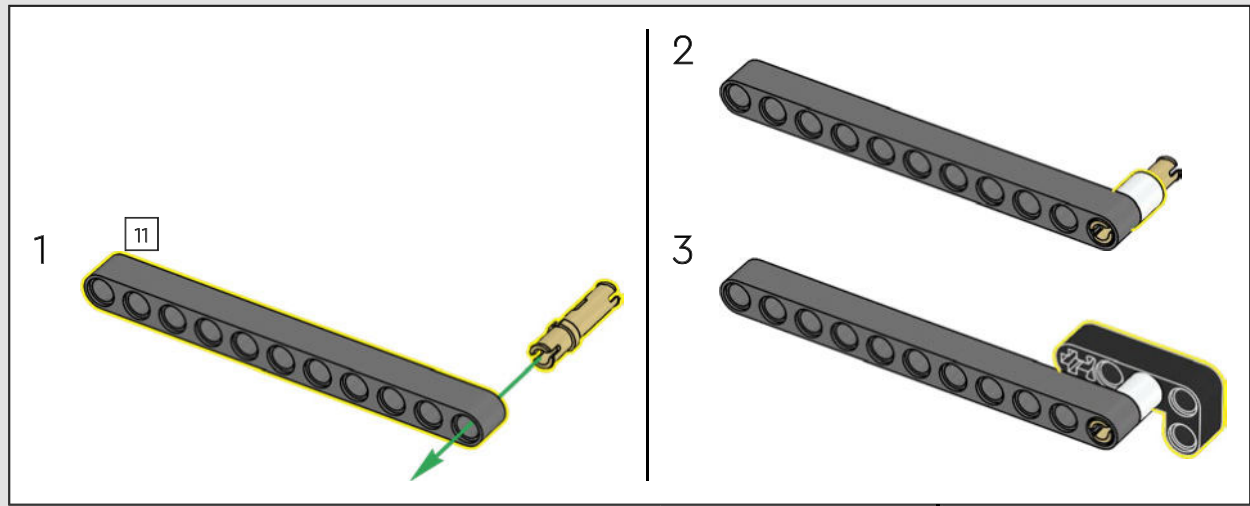

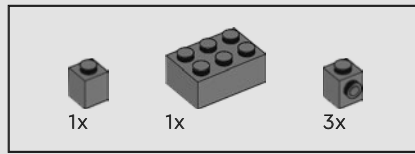

186

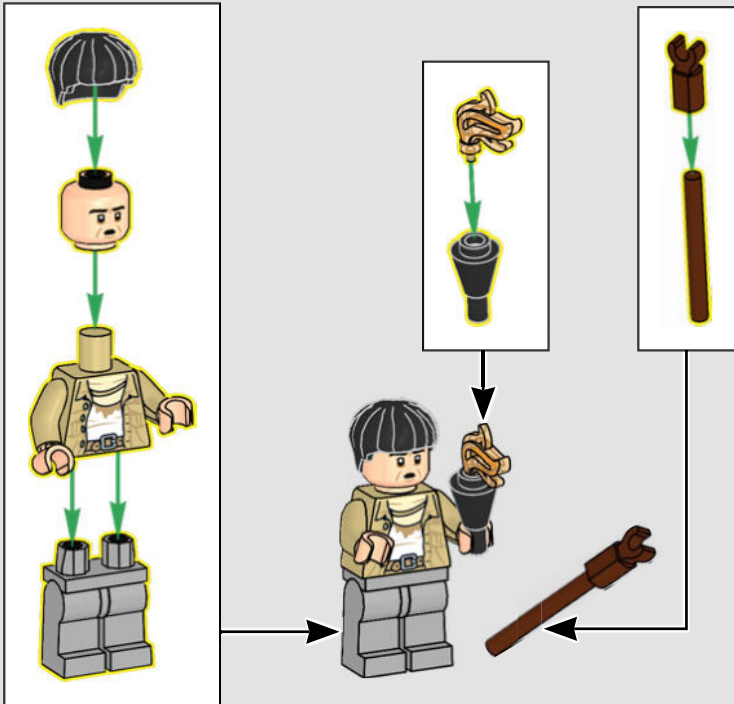
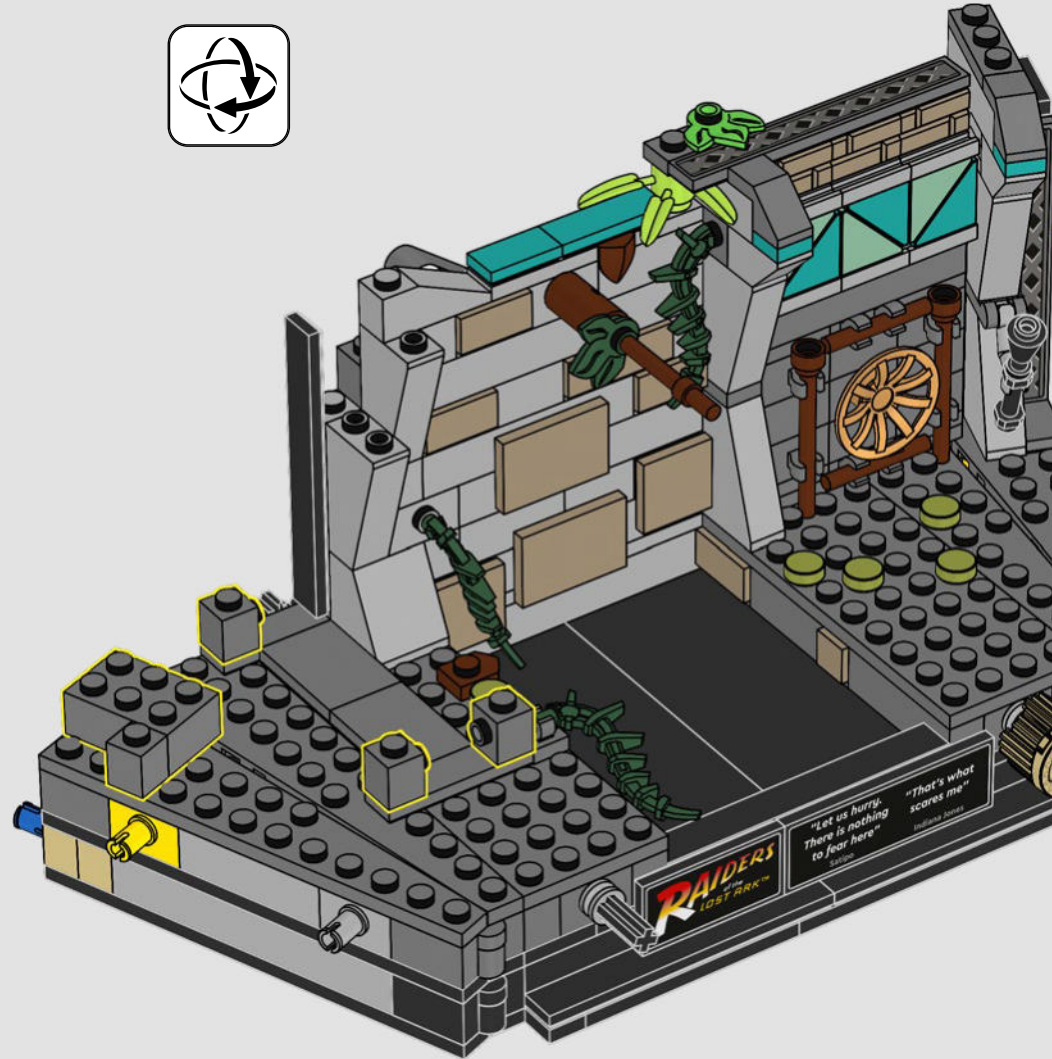
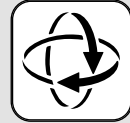

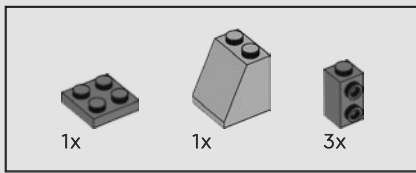

187

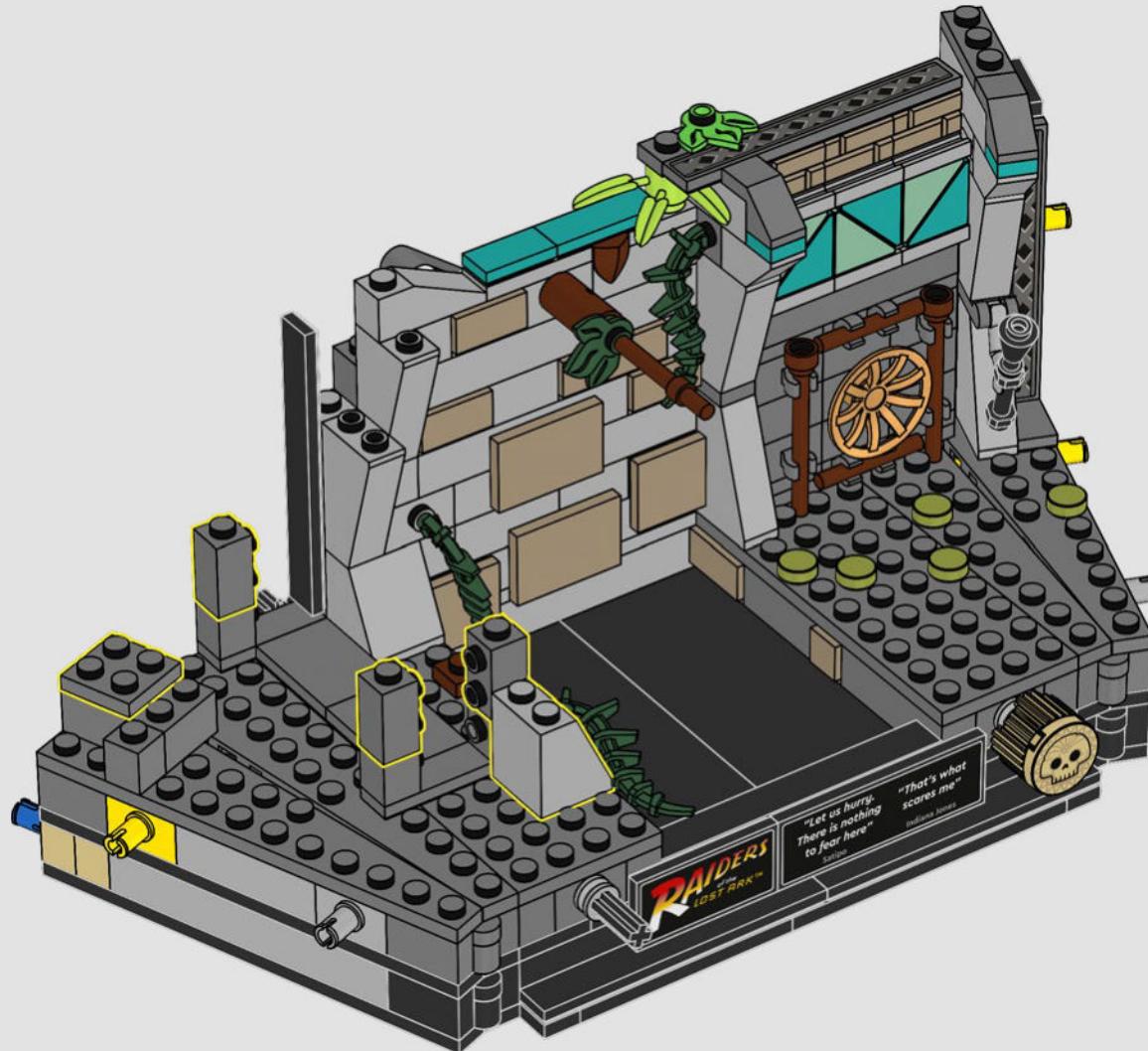

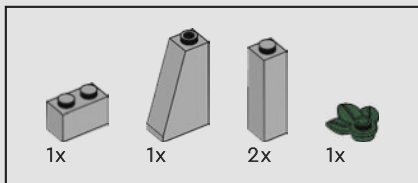

188

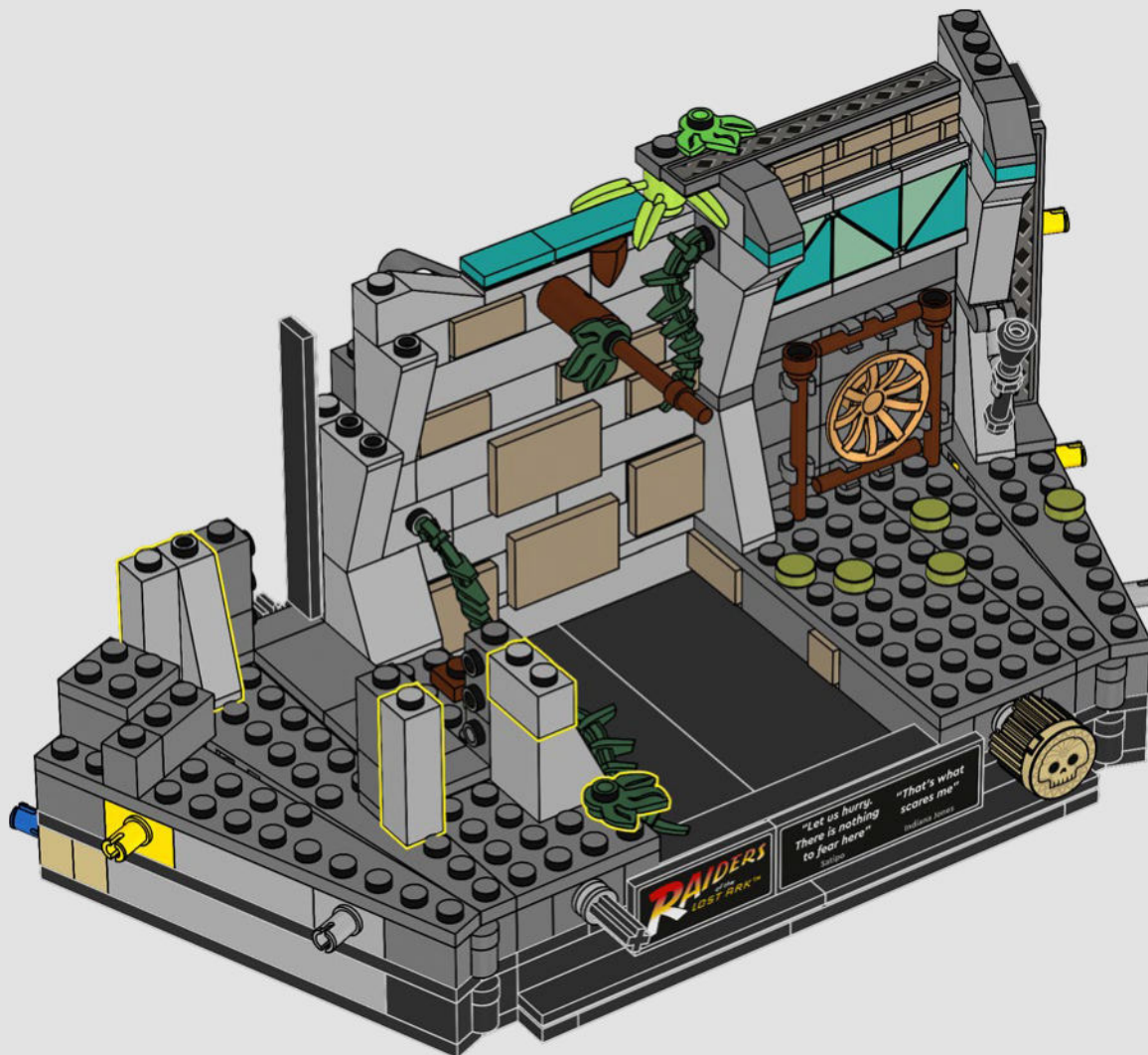

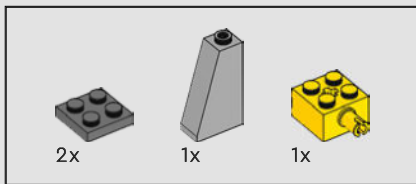

189

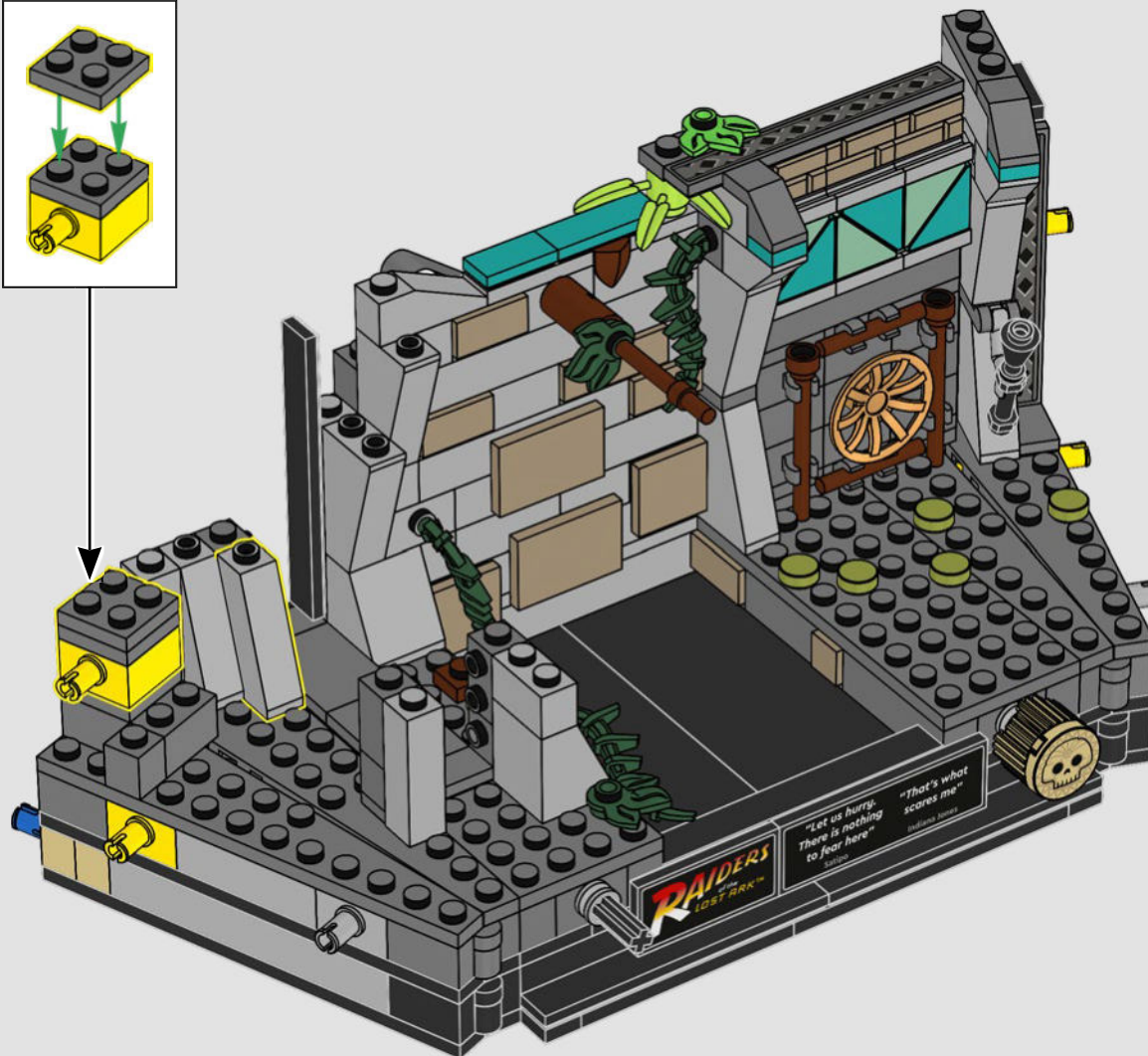
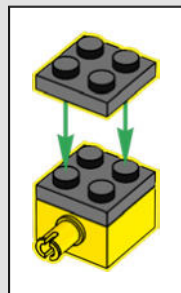

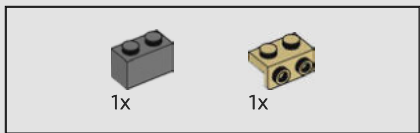

190

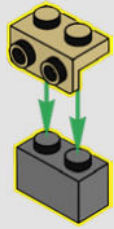

191

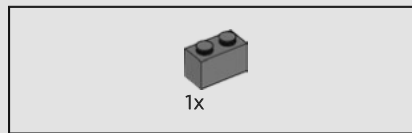
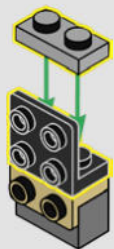

192

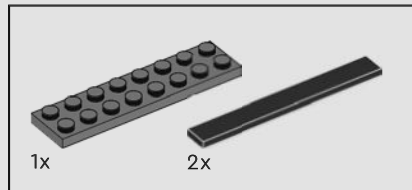

193

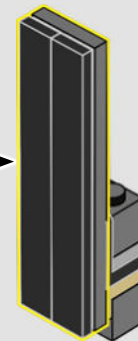
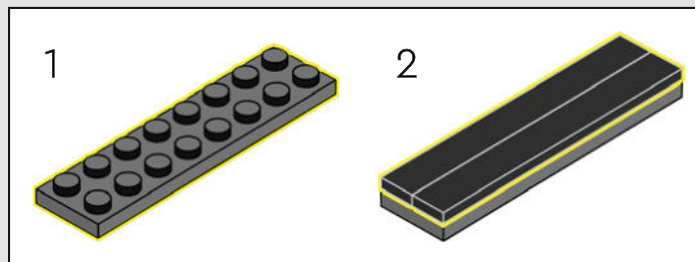

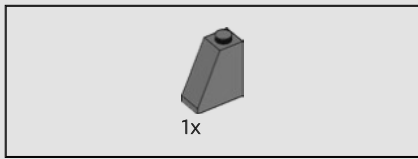

194

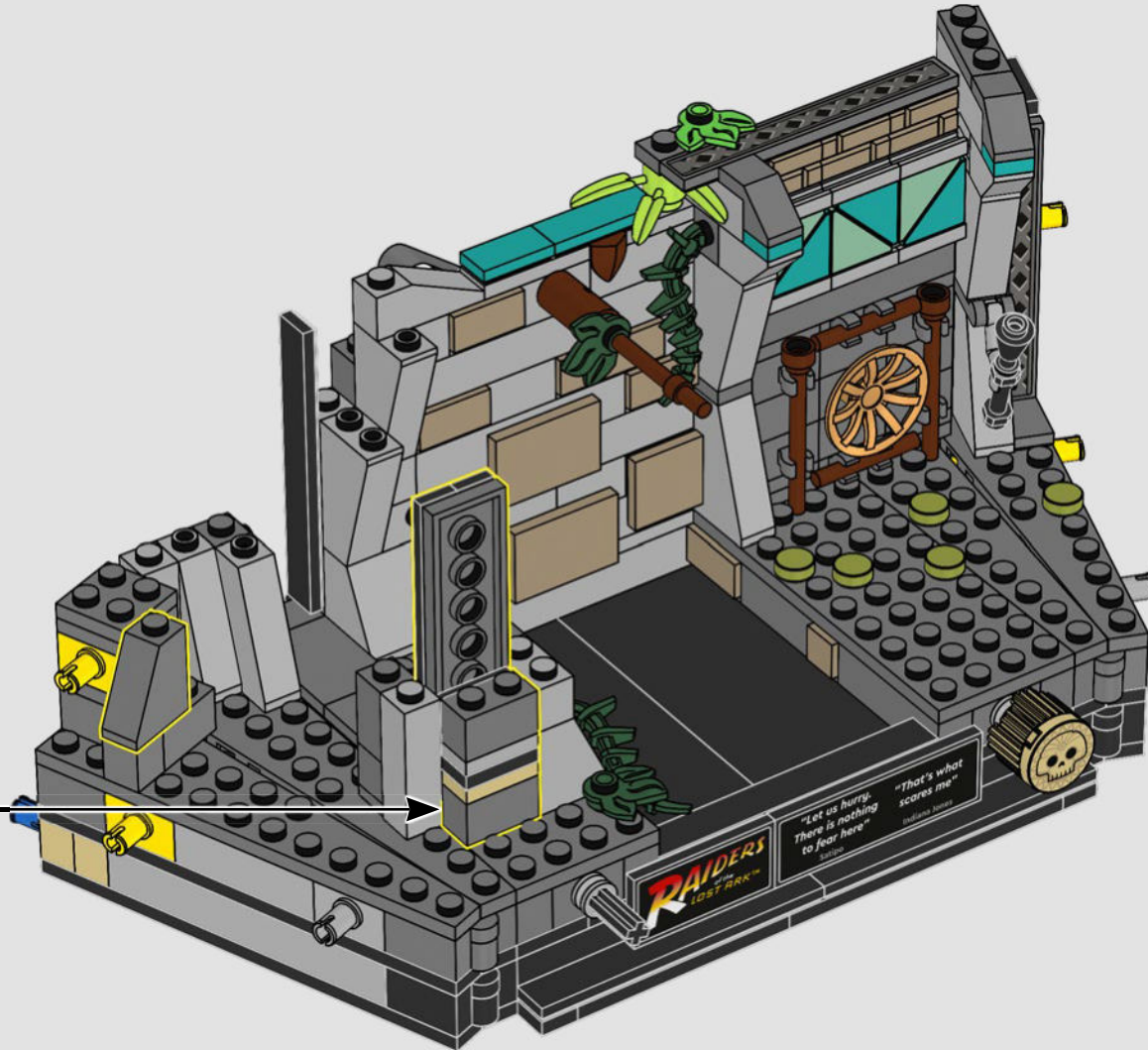

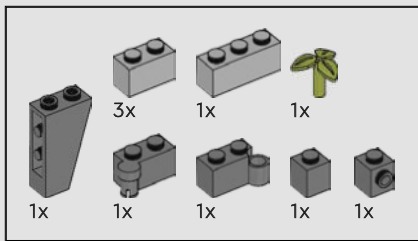

195

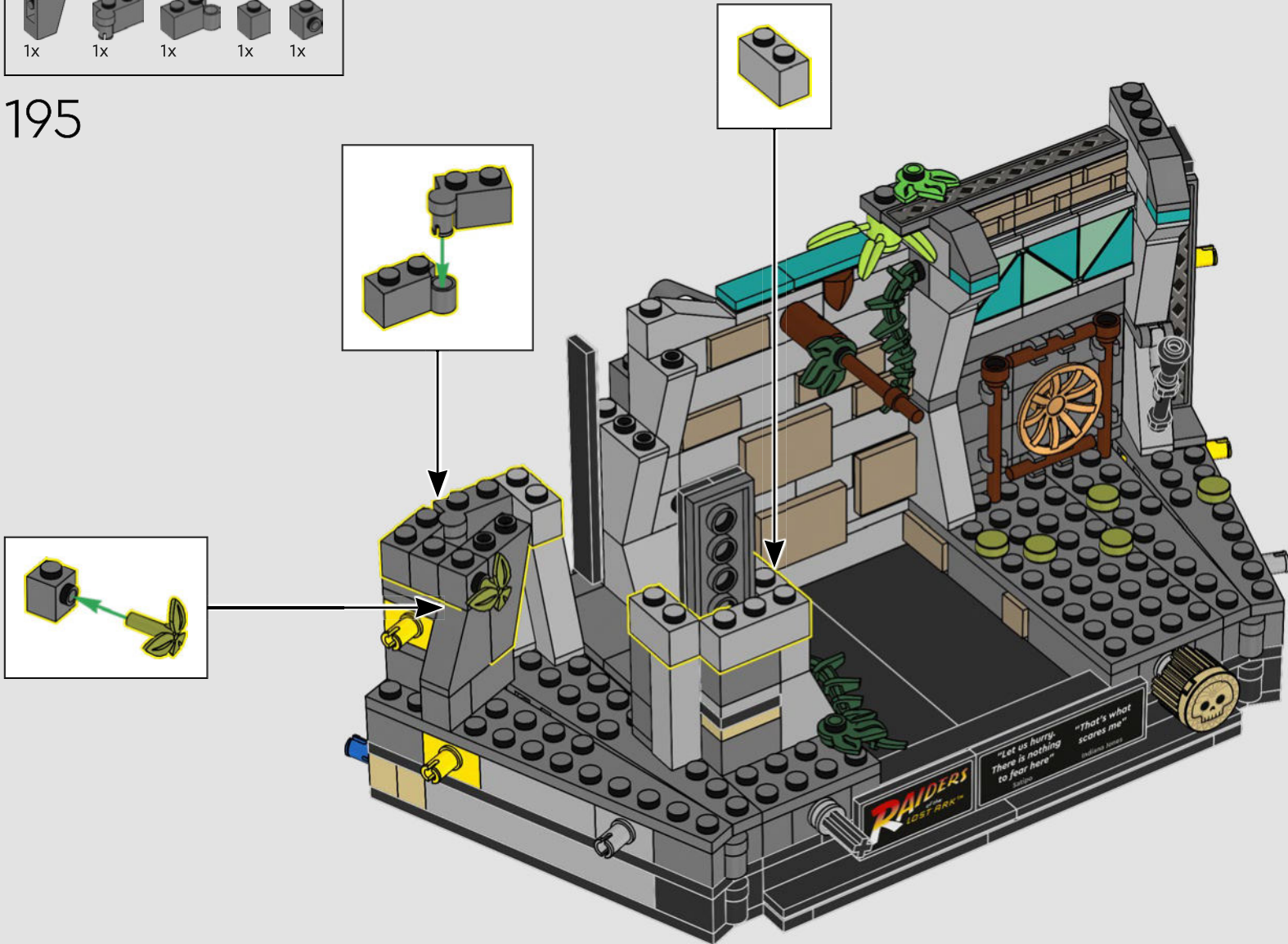

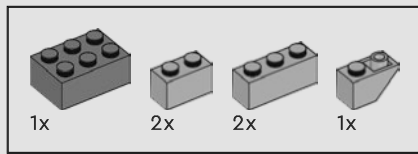

196

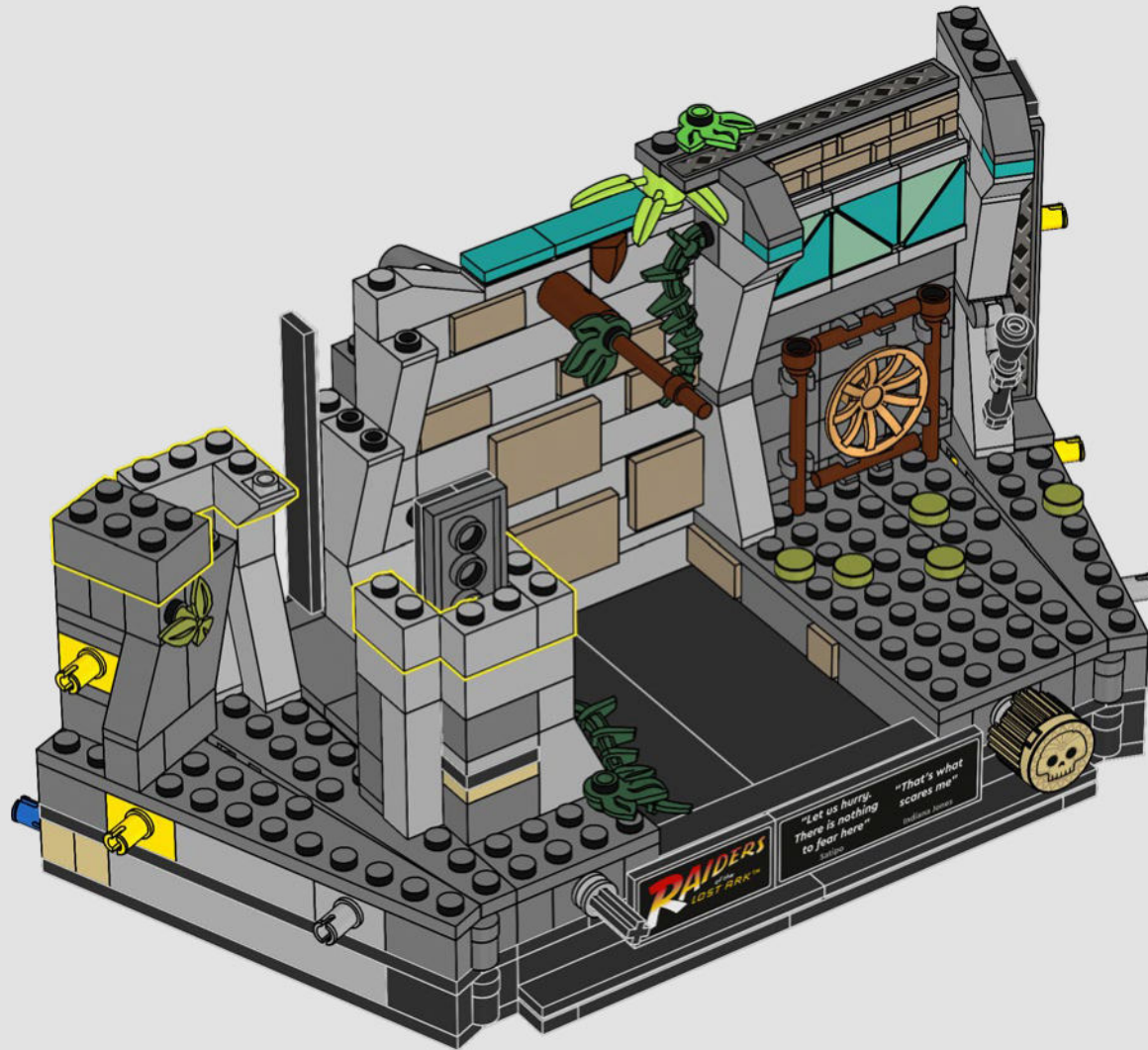

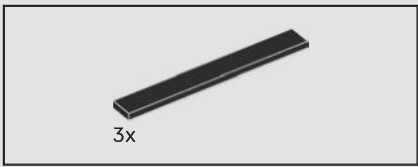

197

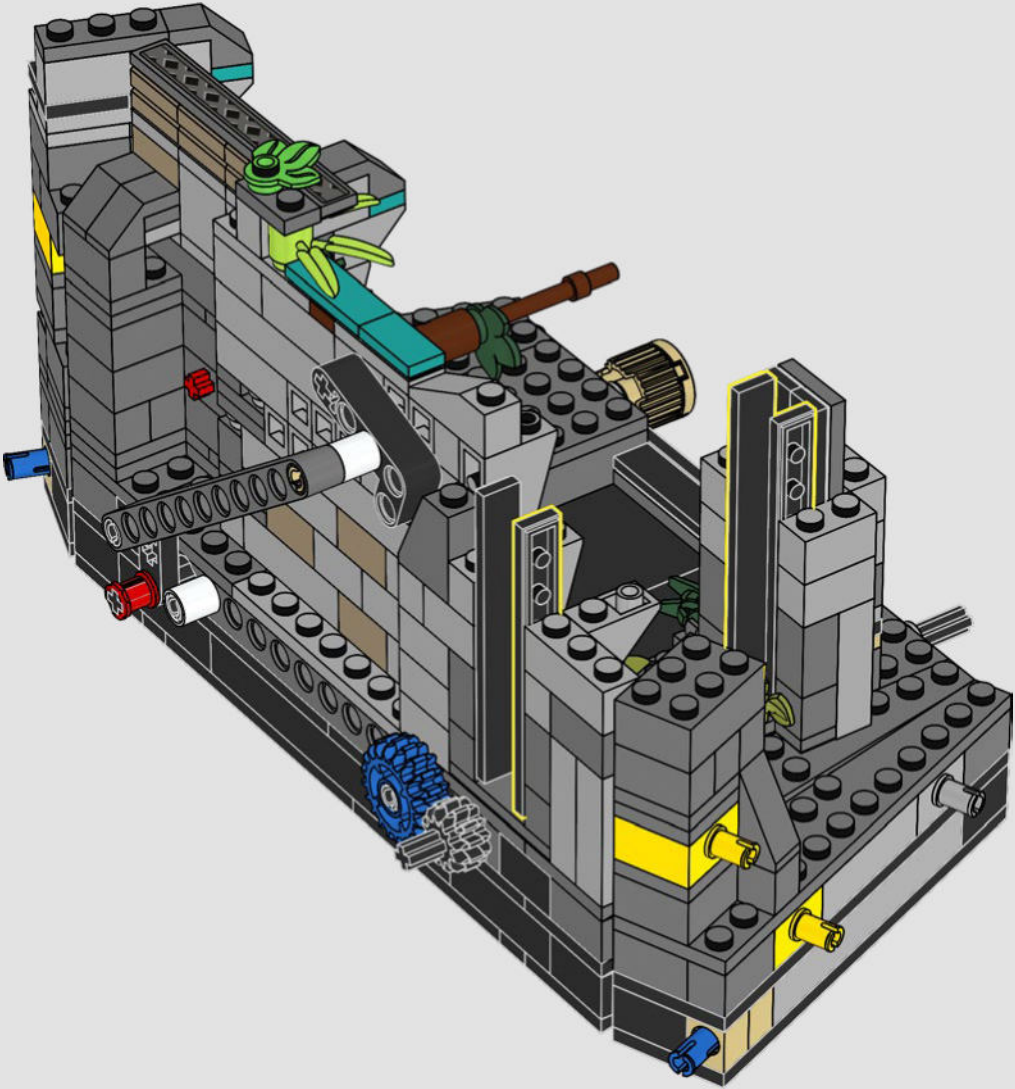

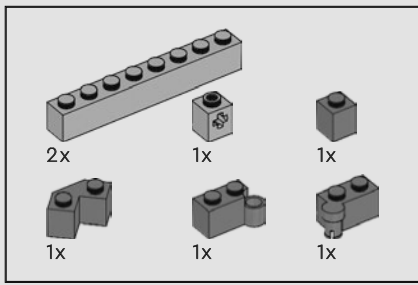

198

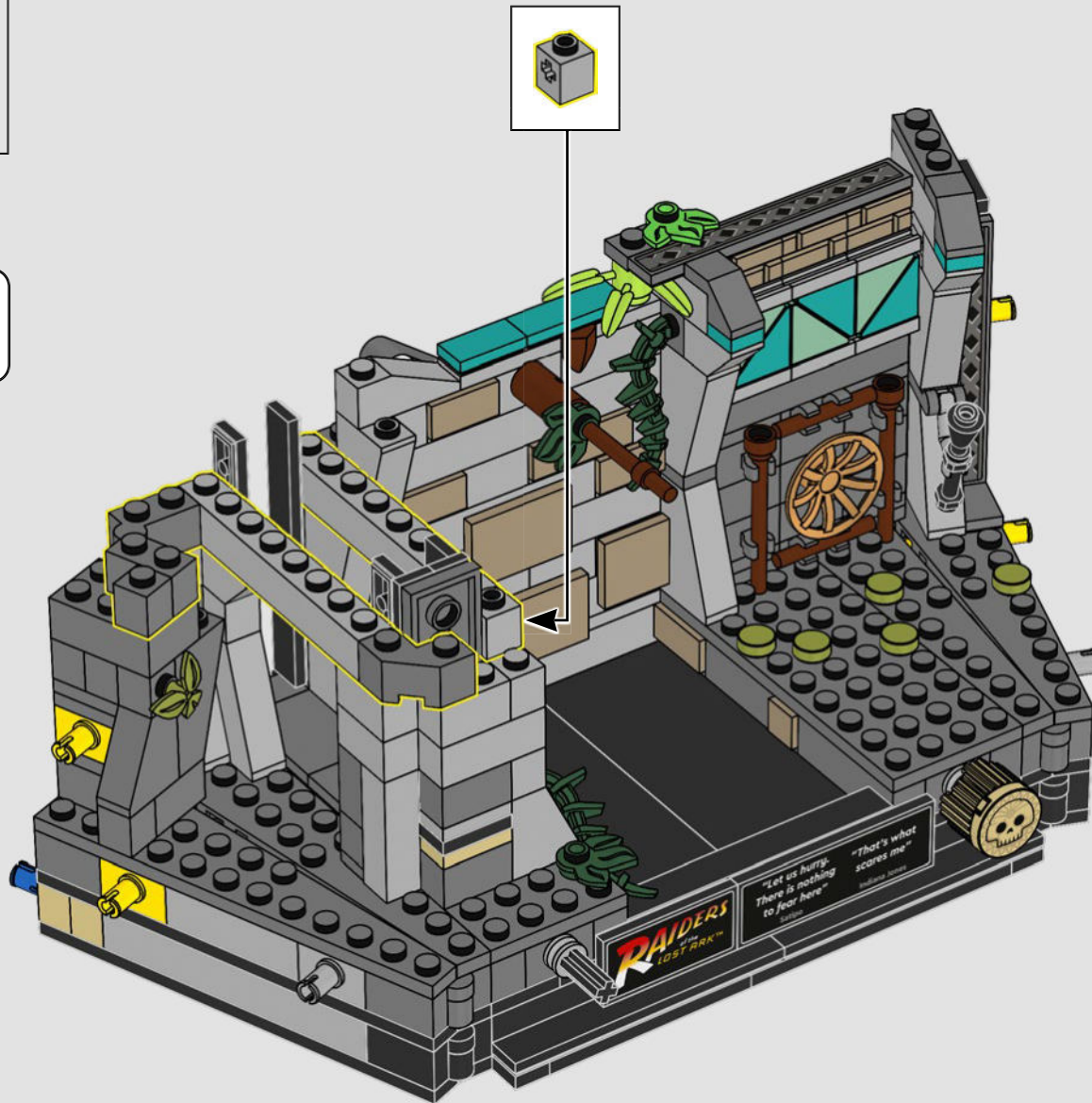

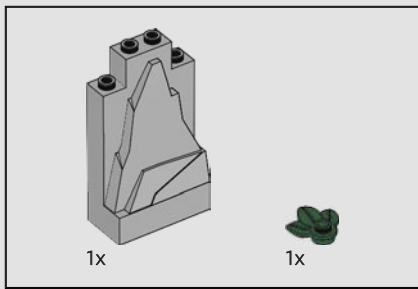

199

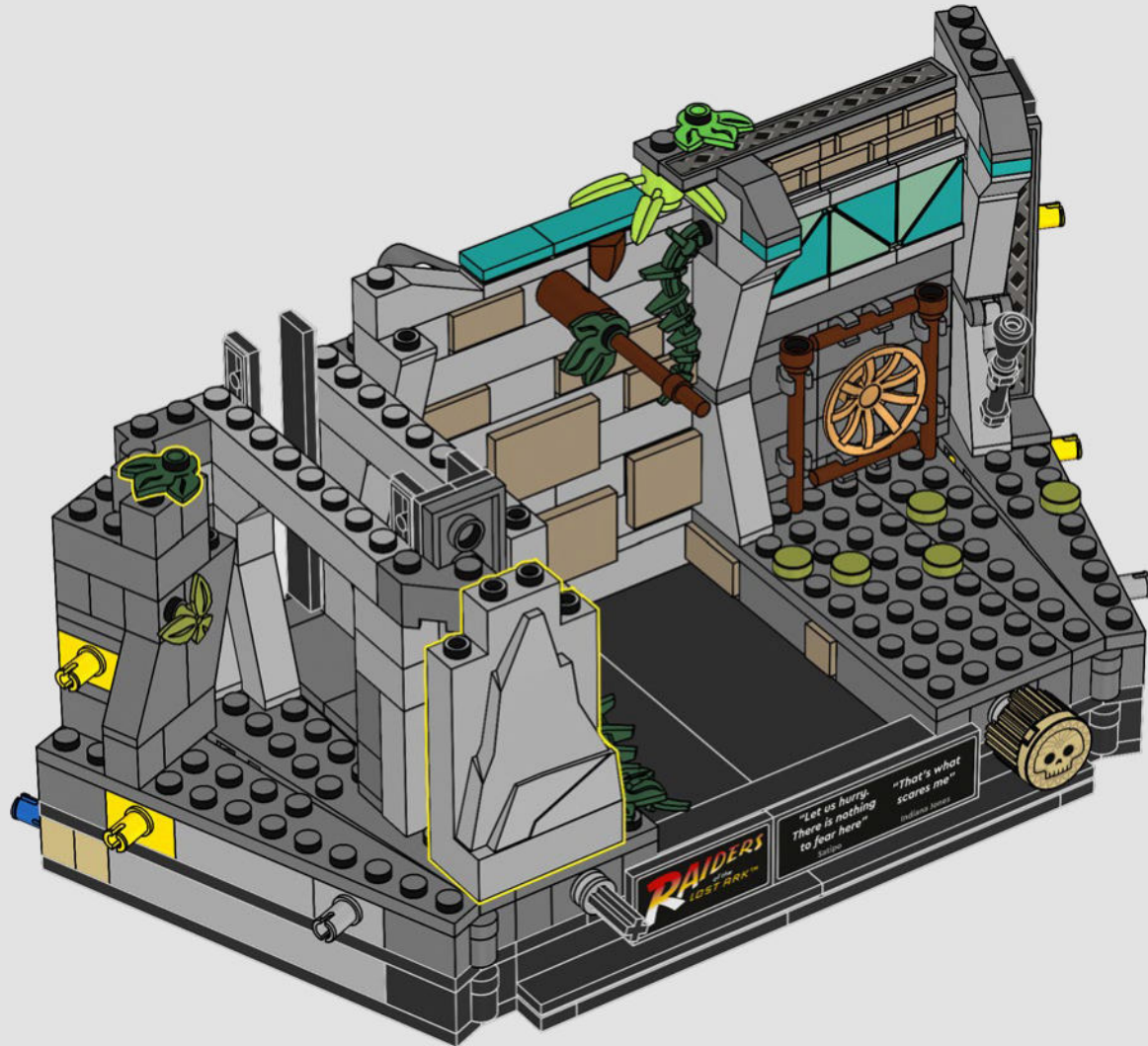

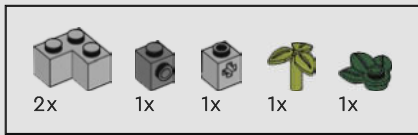

200

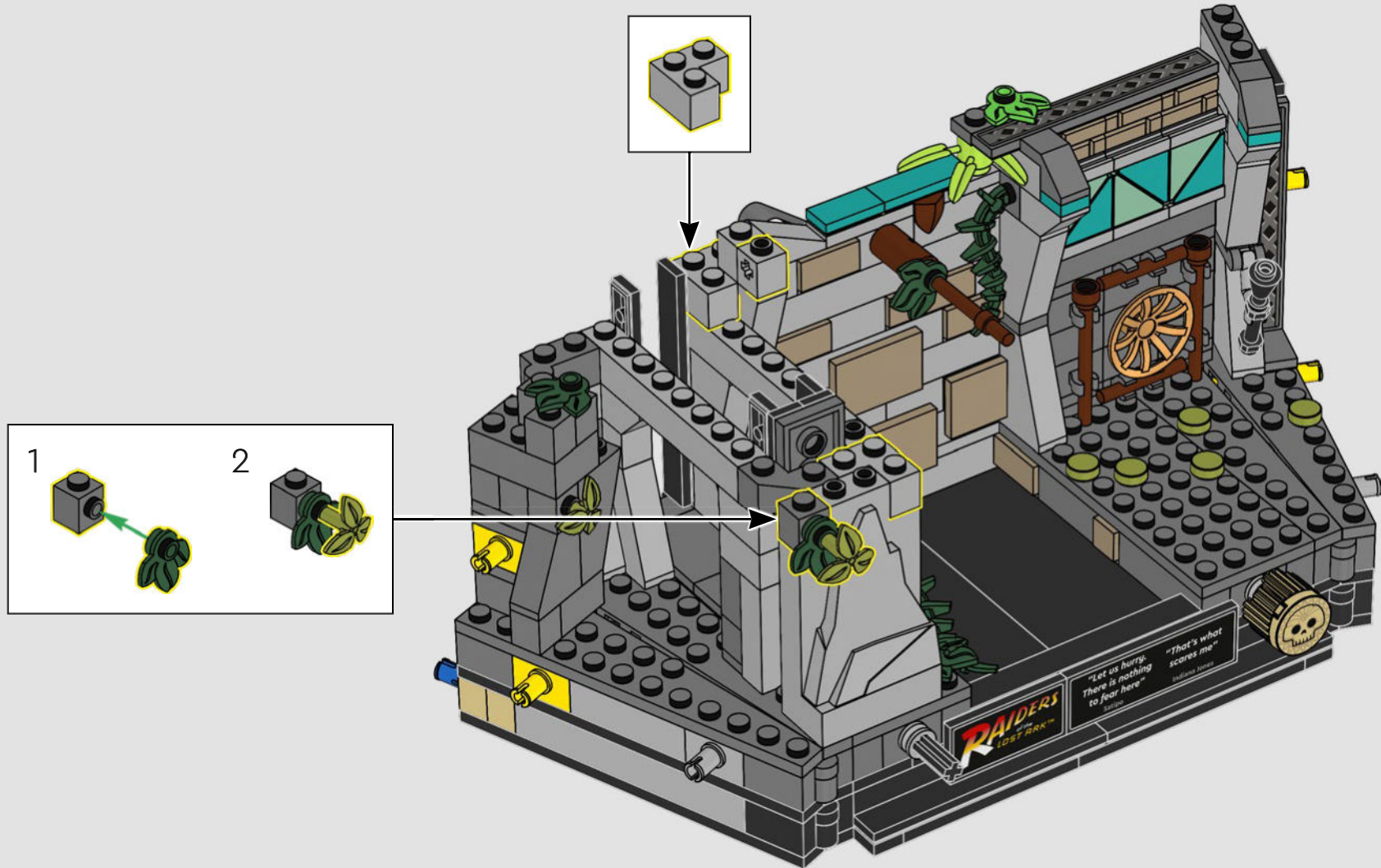

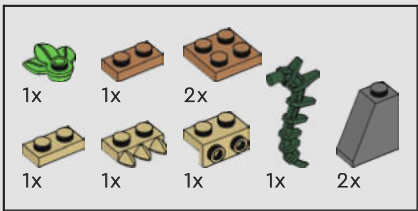

201

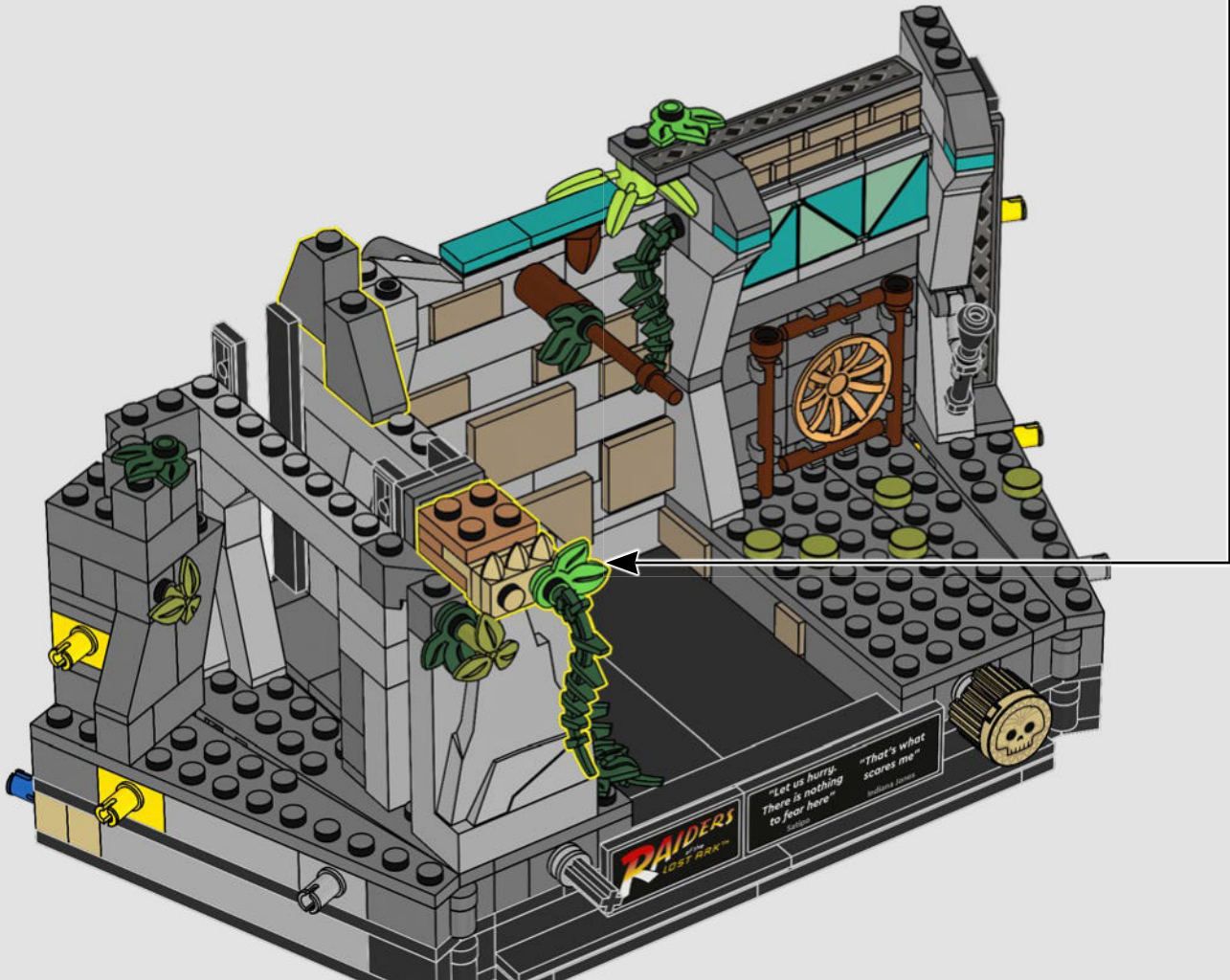
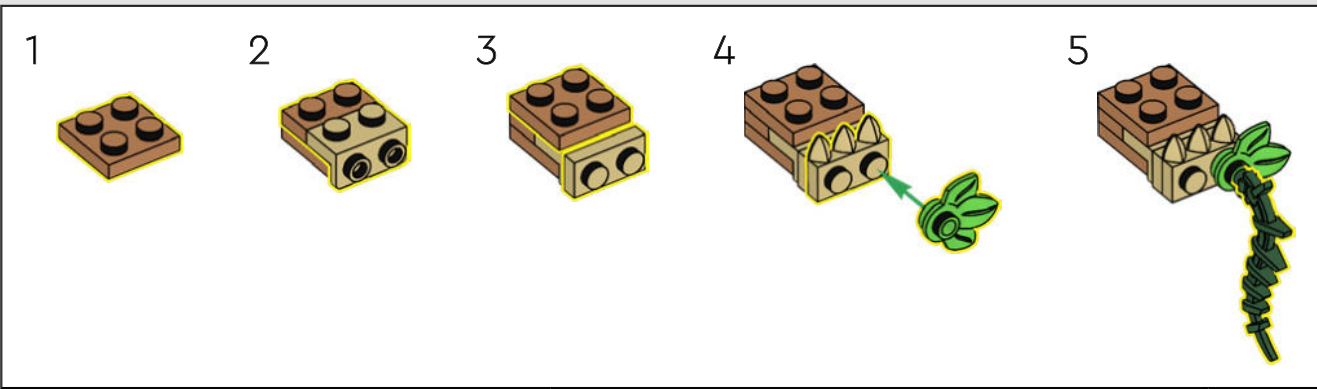

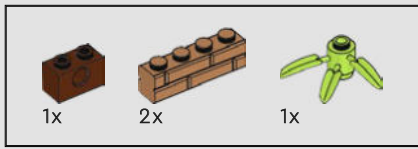

202

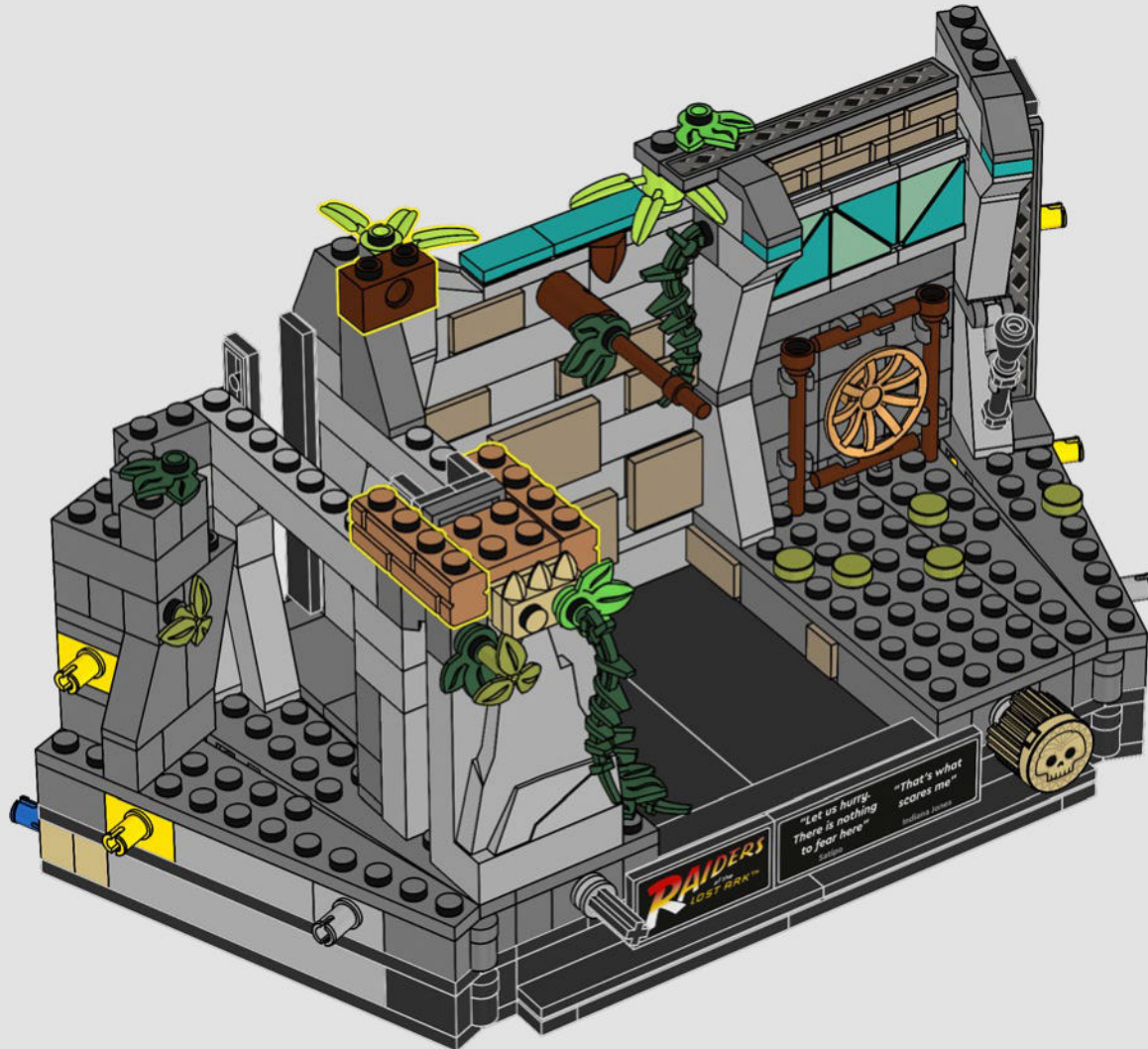



1x

203

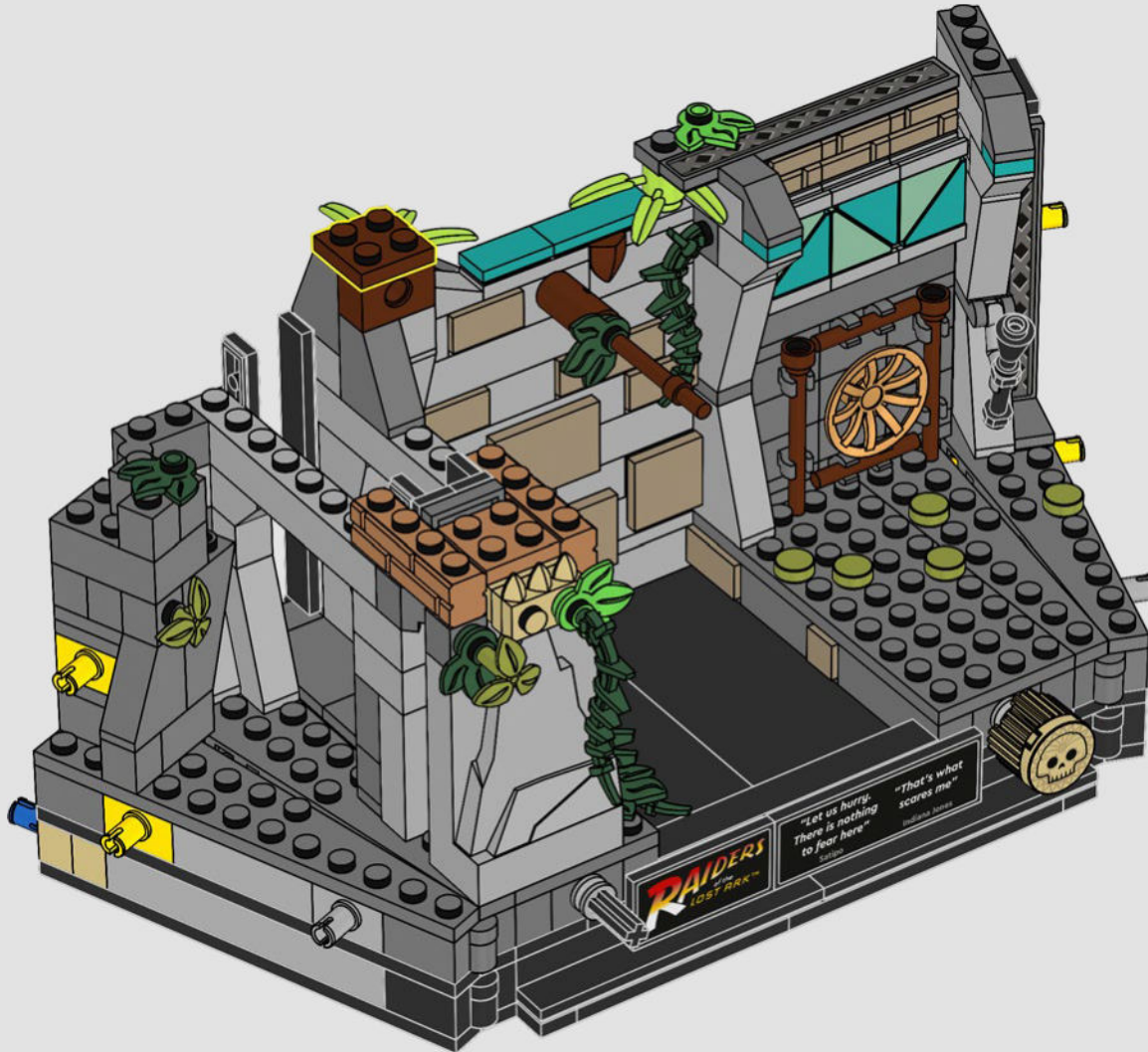

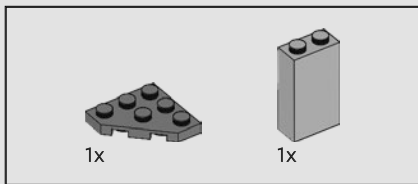

204

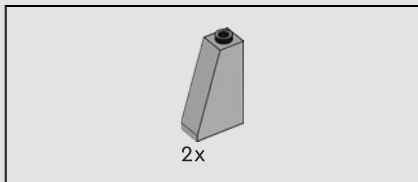
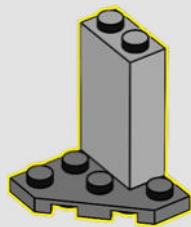

205

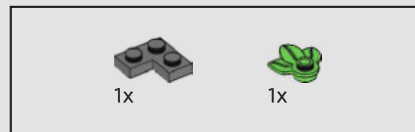
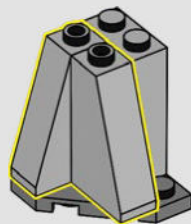

206



207

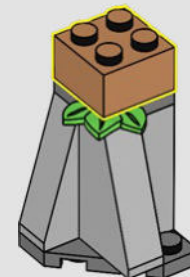

208



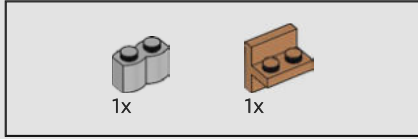
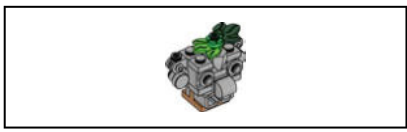

209

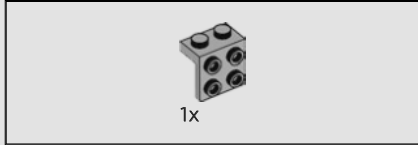
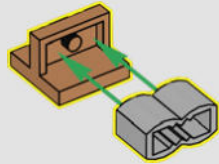

210

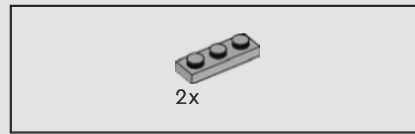
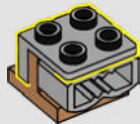

211

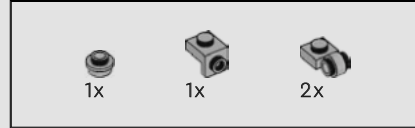
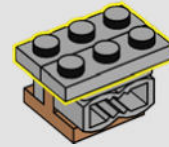

212

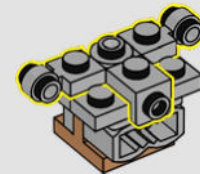



2x

213

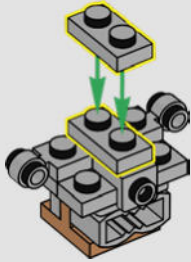

2x



2x

214

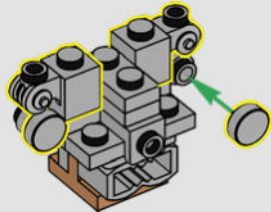

2x

215

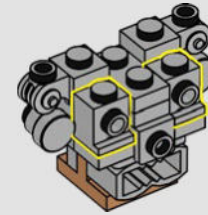

1x



2x

216

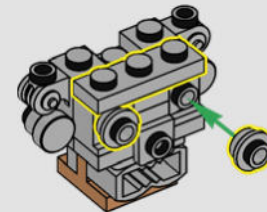



217

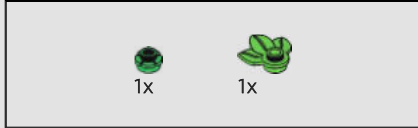
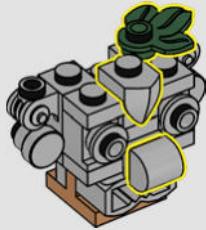

218

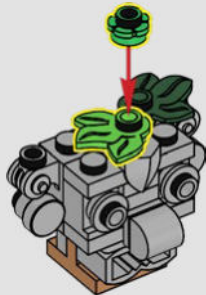

219



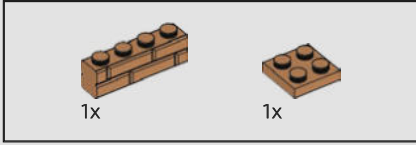
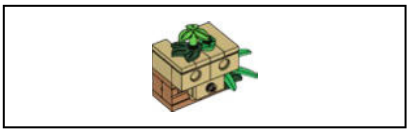

220

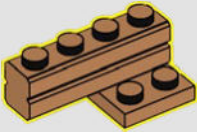

221

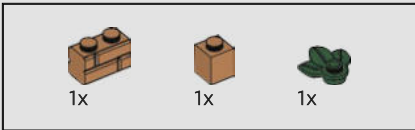
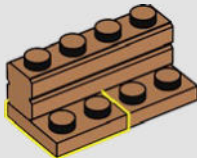

222

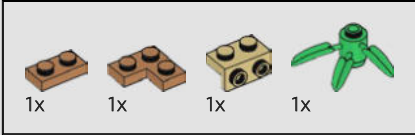
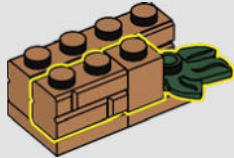

223

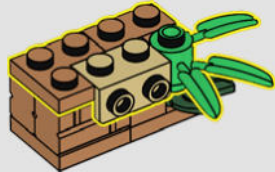

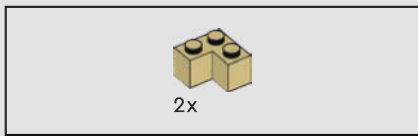

224

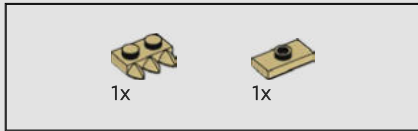
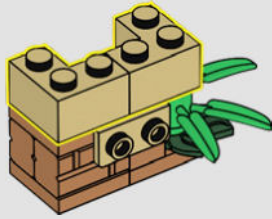

225

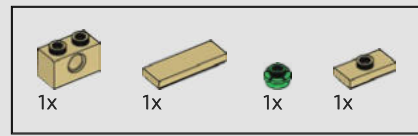
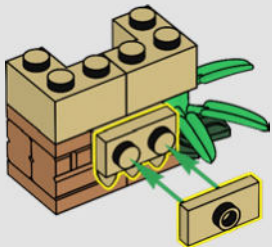

226

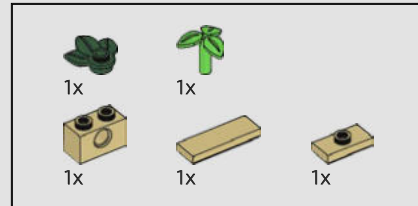
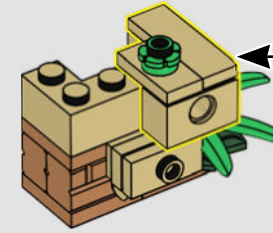
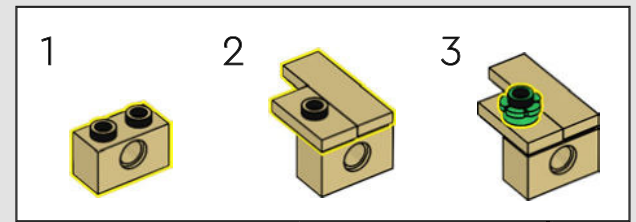

227

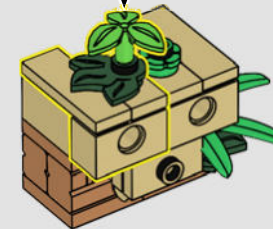
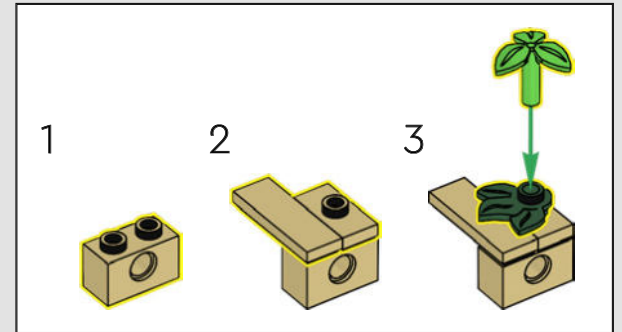

228

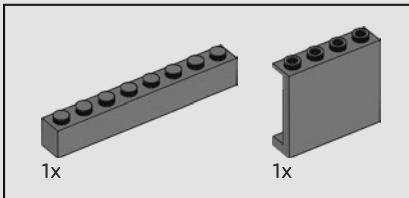
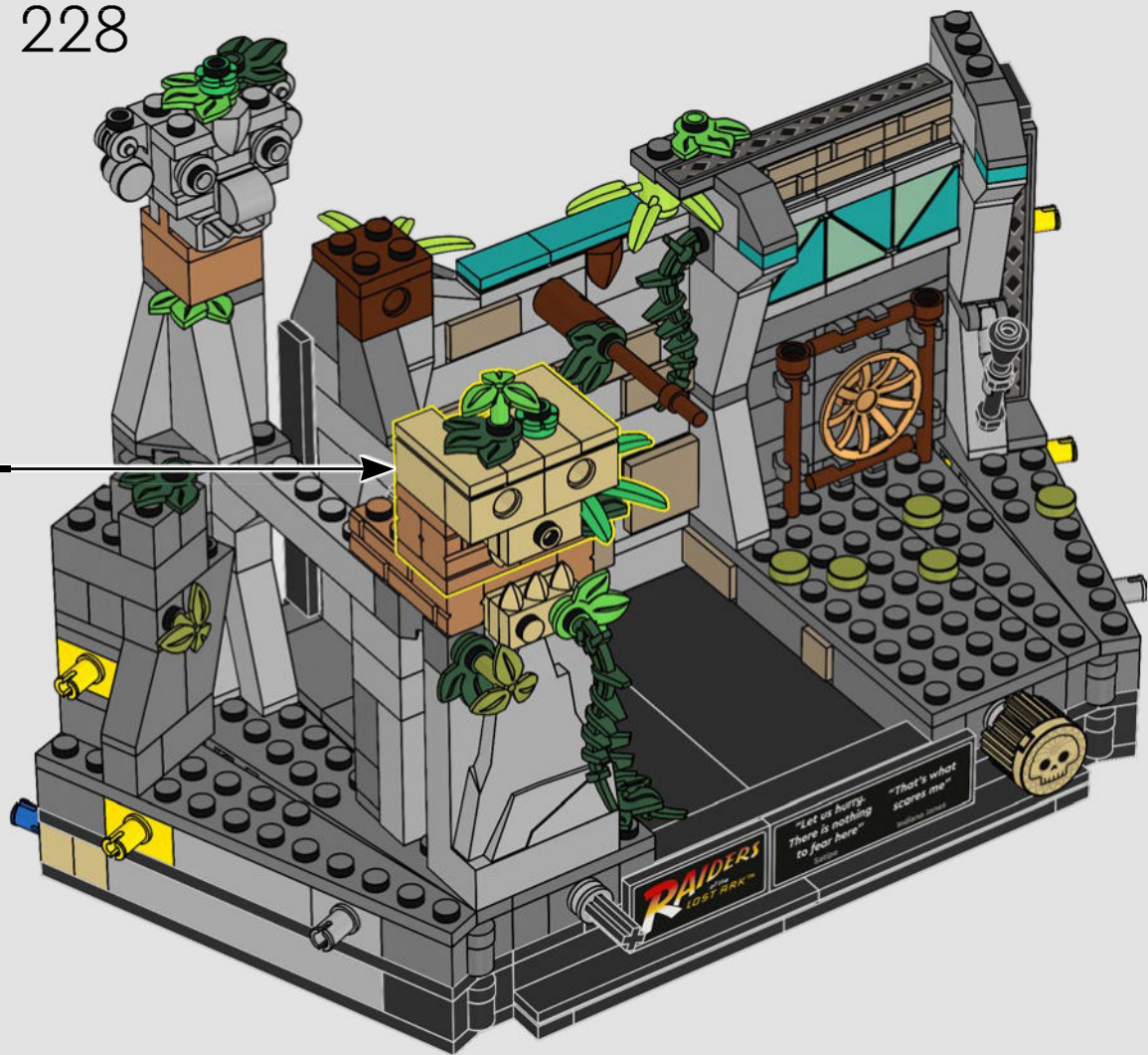

1x

1x

229

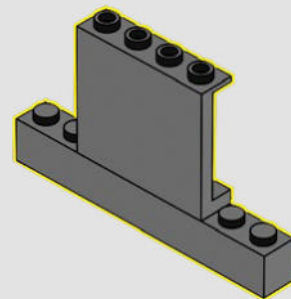

1:1

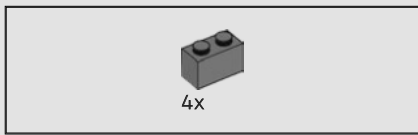

230

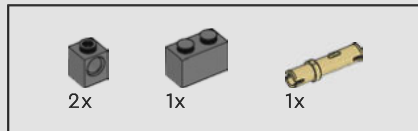
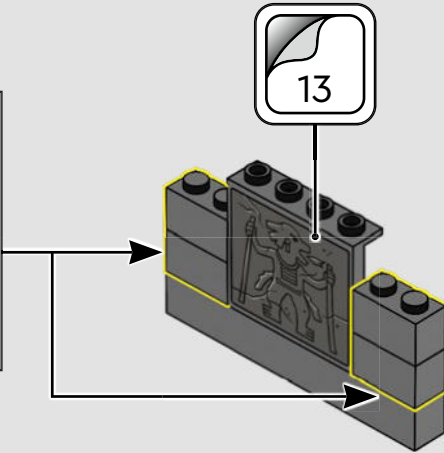
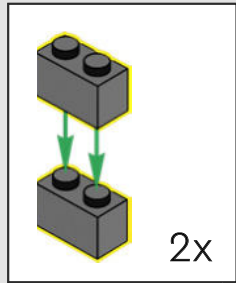

231

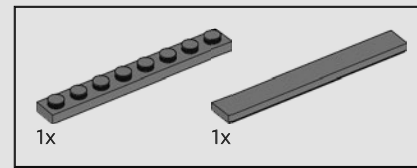
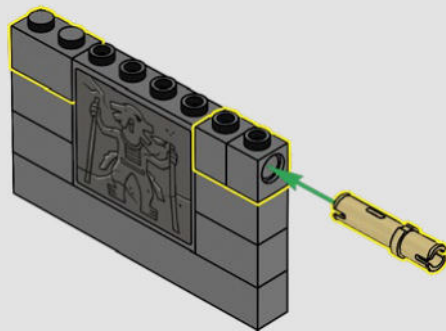

232

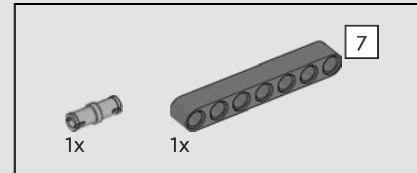
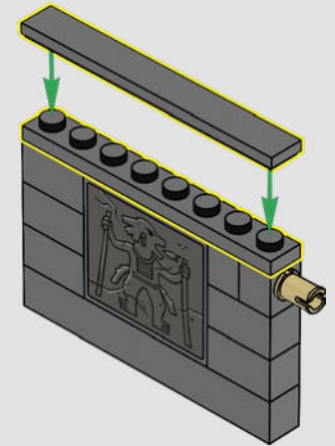

233

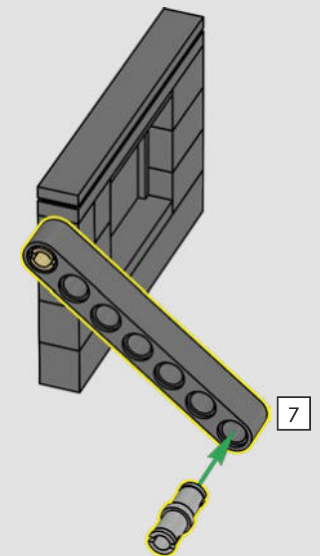
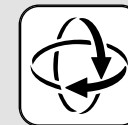

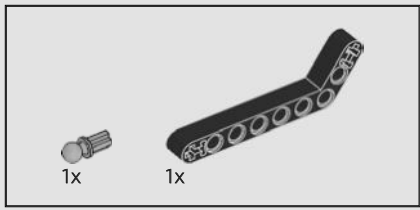

234

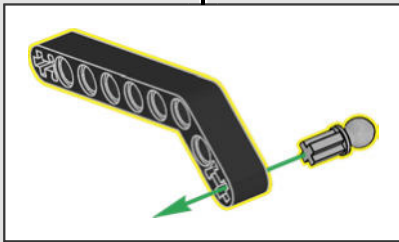
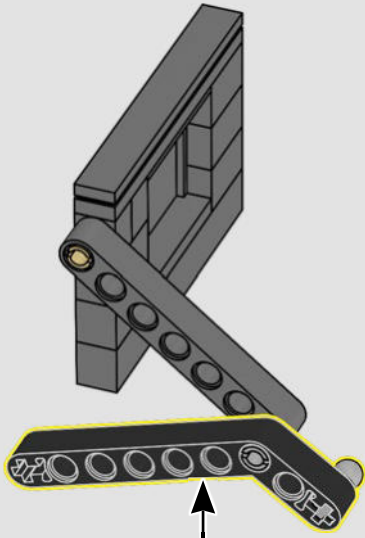

235

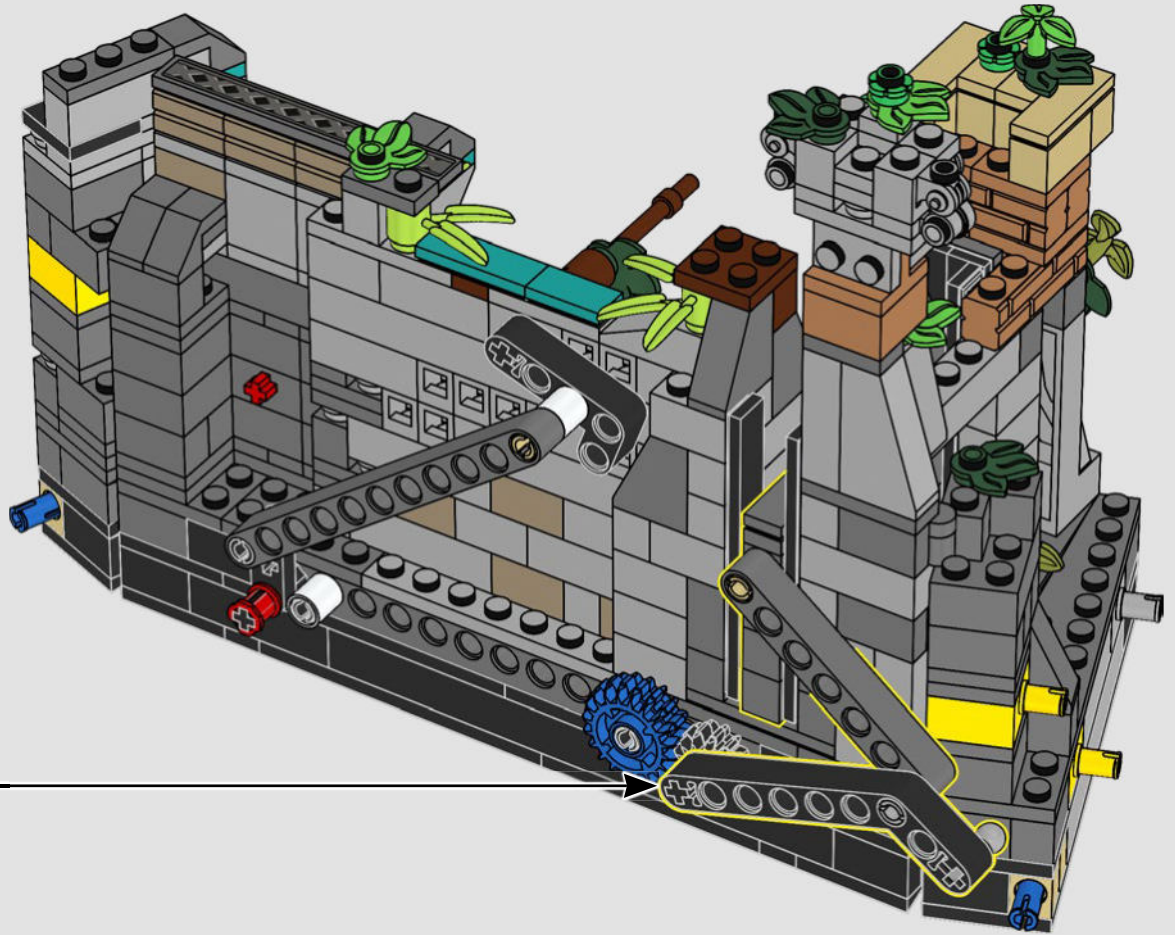
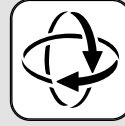

236

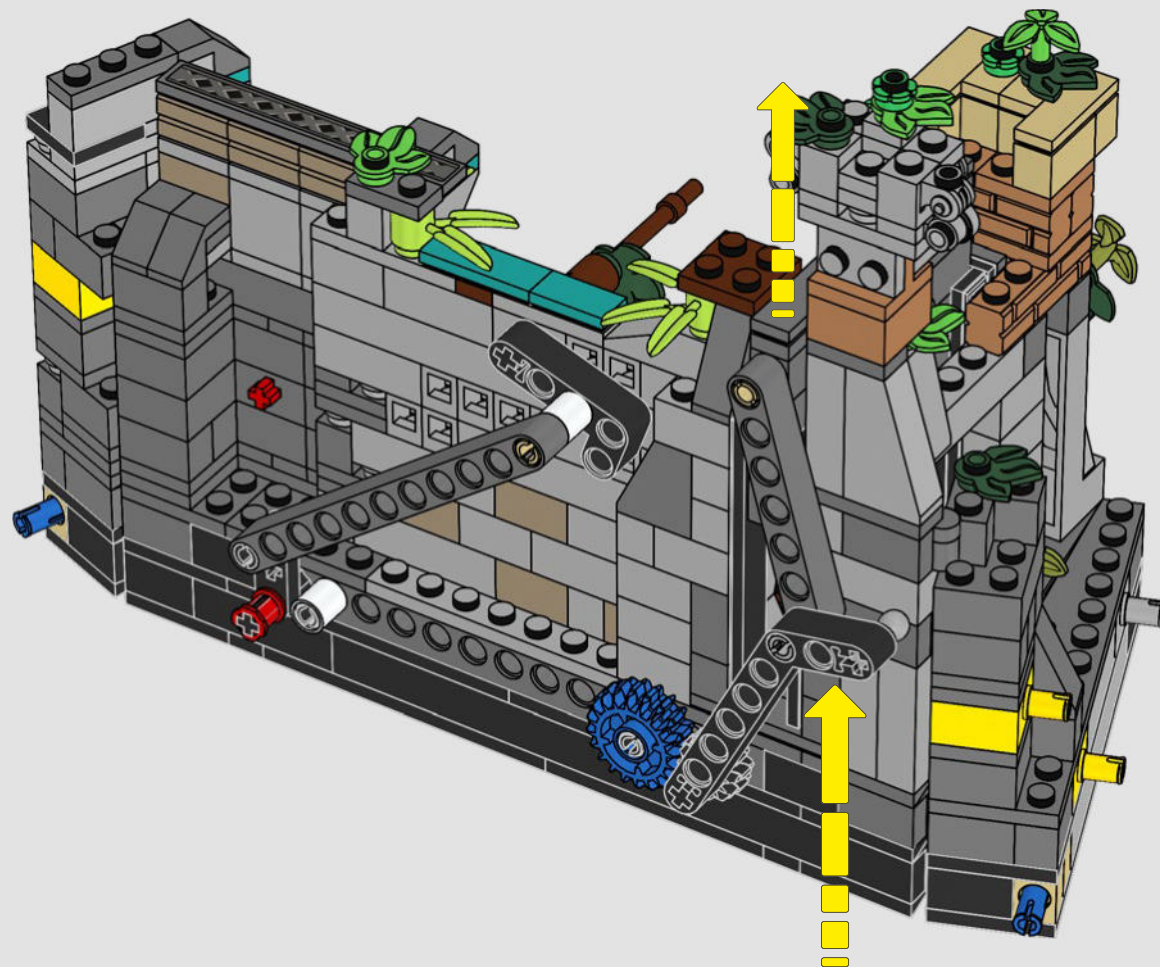

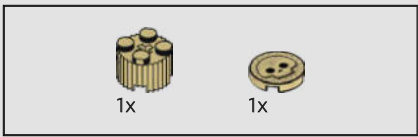

237

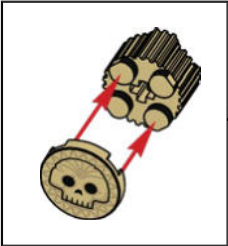
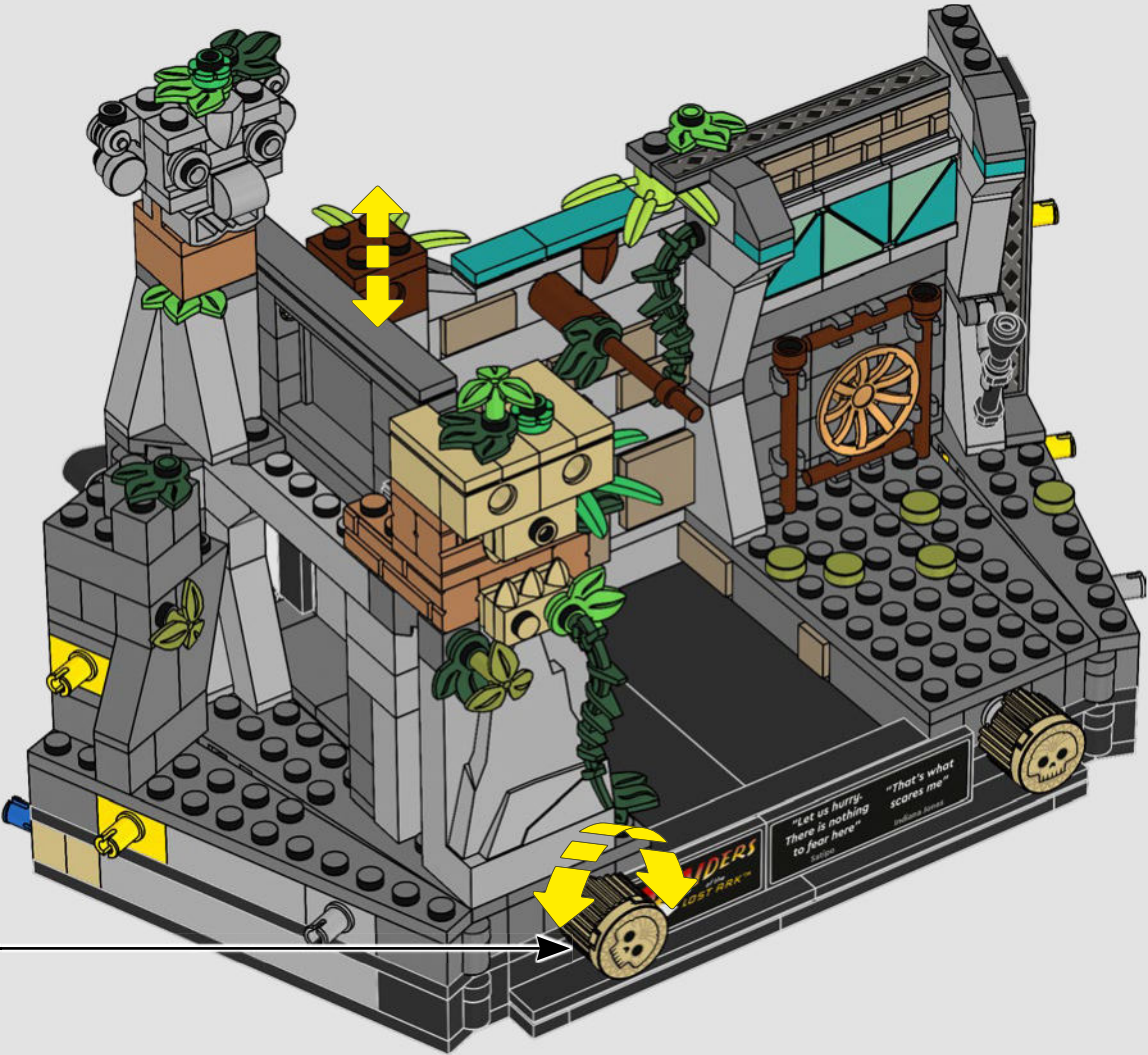

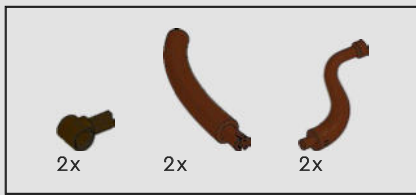

238

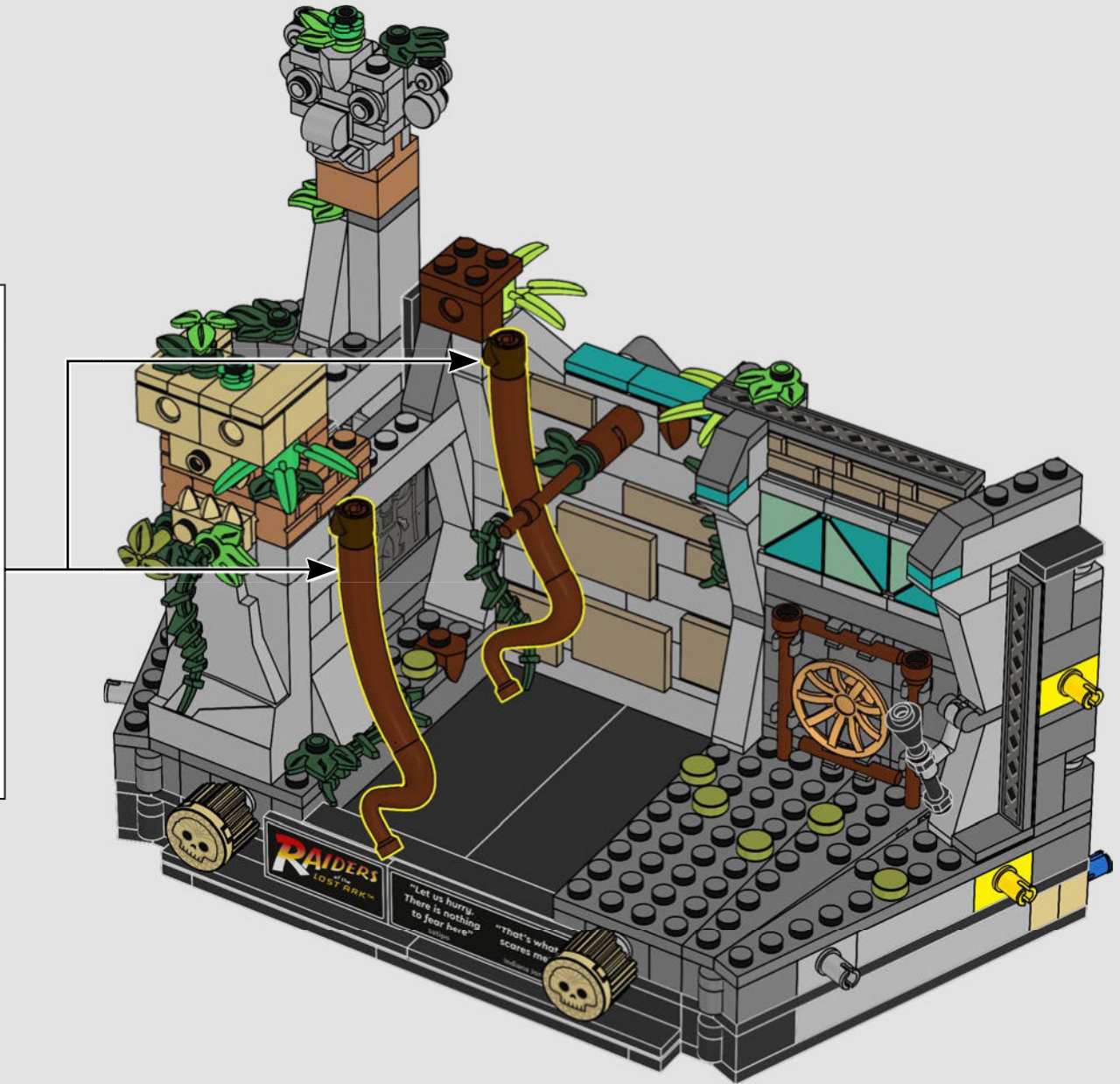
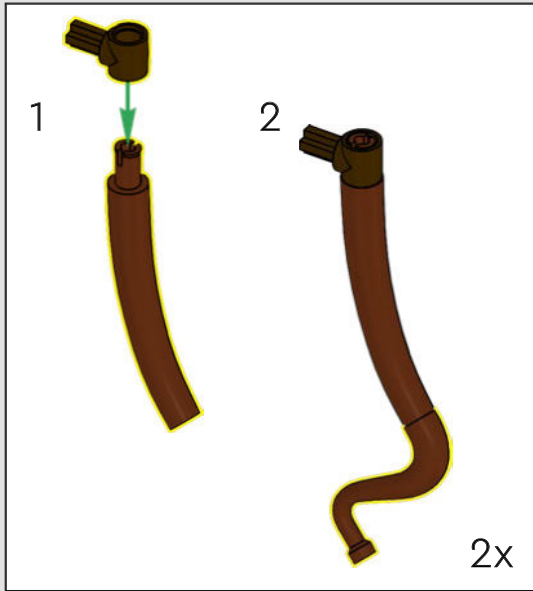

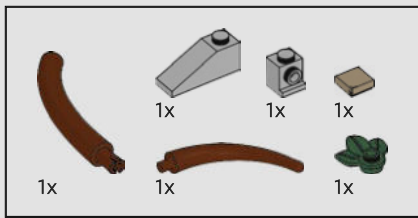

239

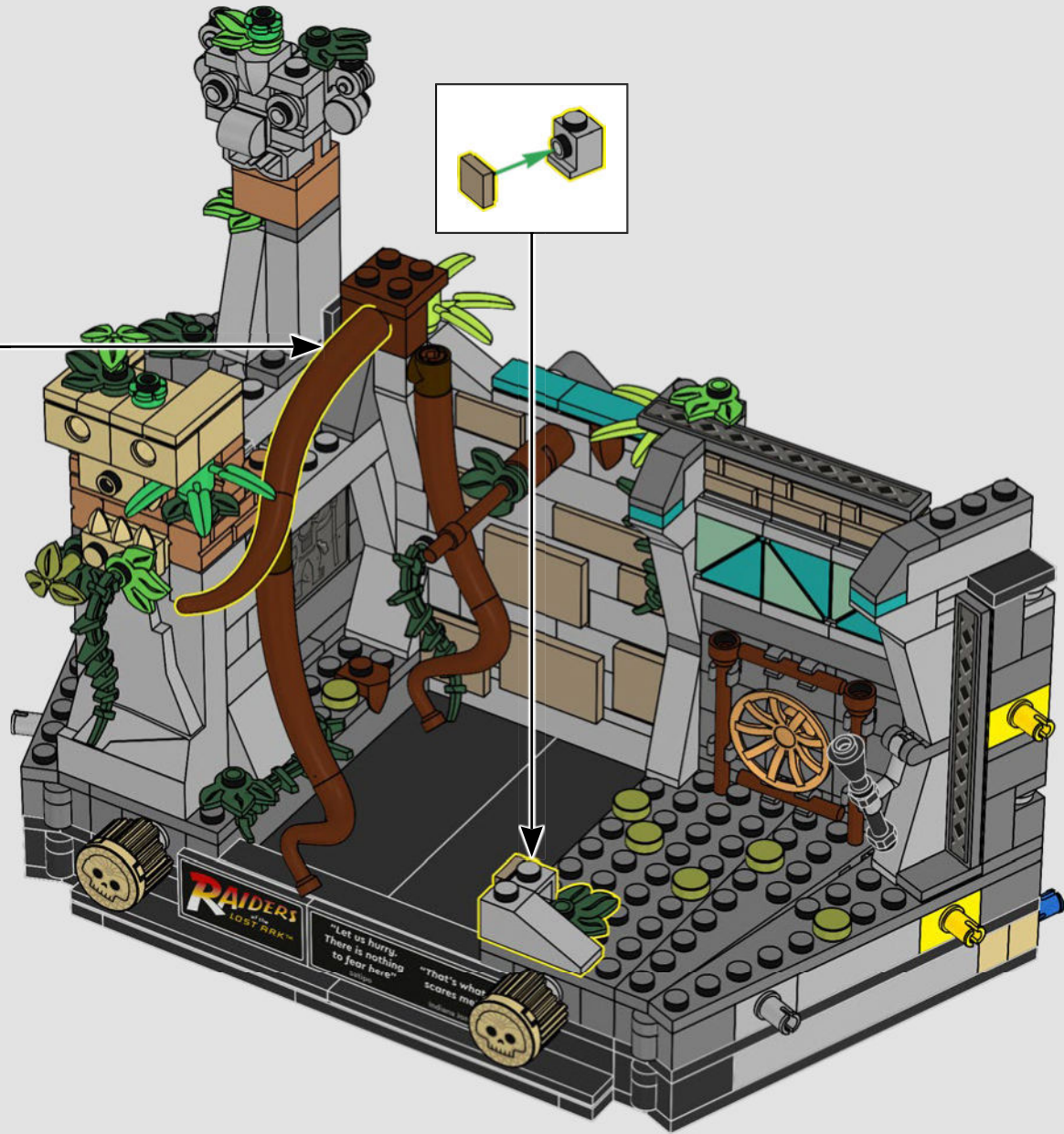
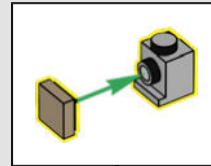
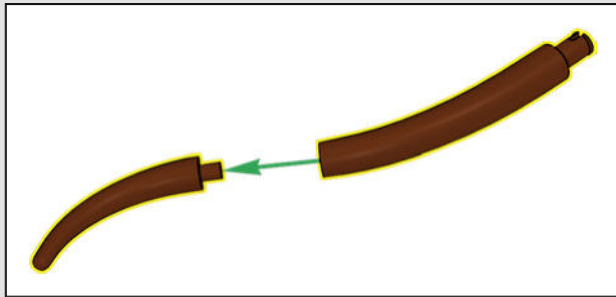

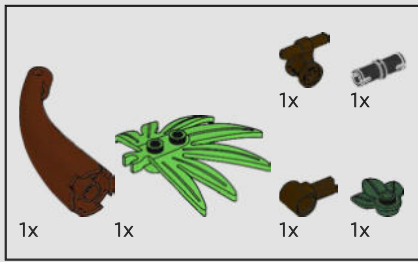

240

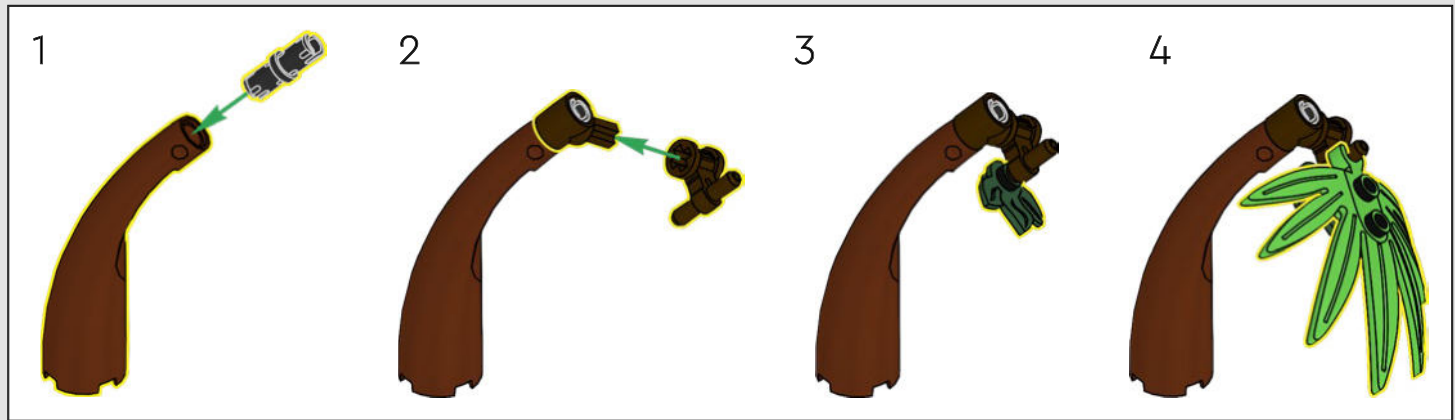



1x

241



242



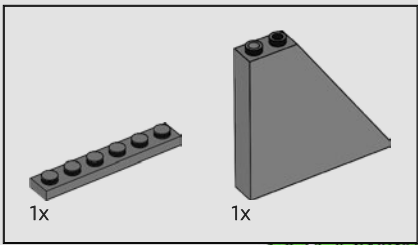

243

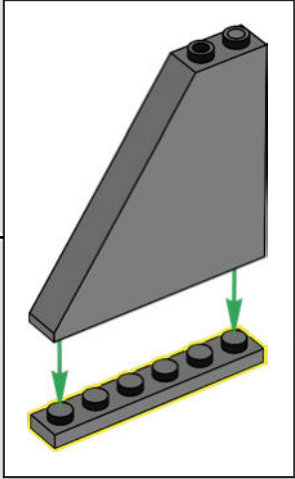

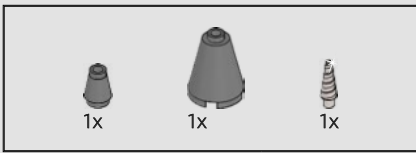

244

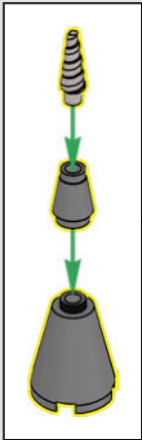



245

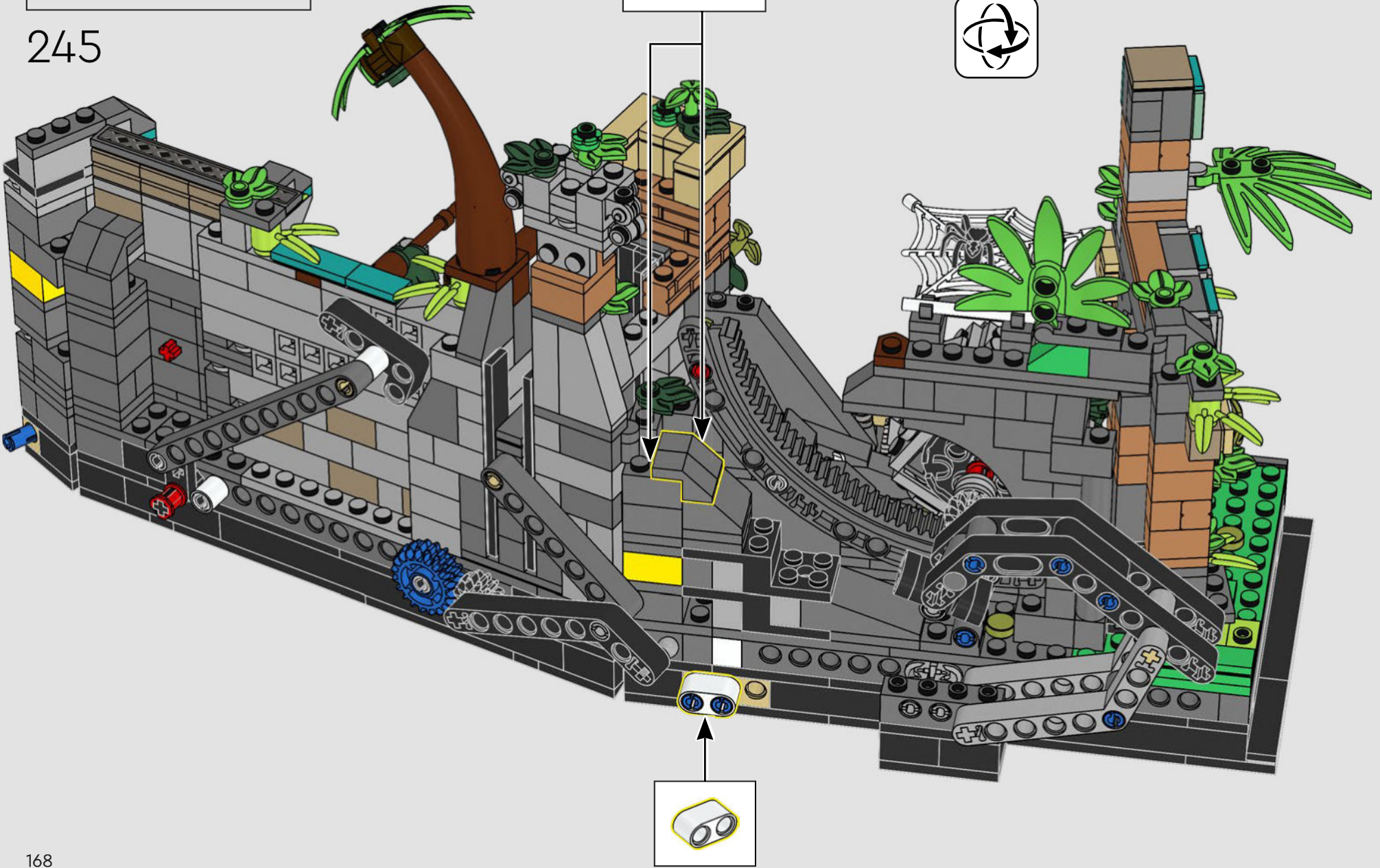
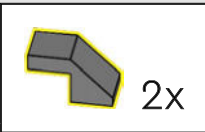

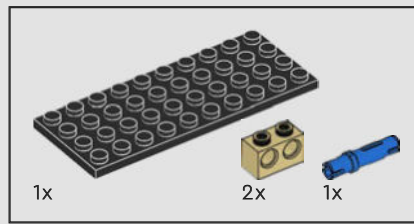

246

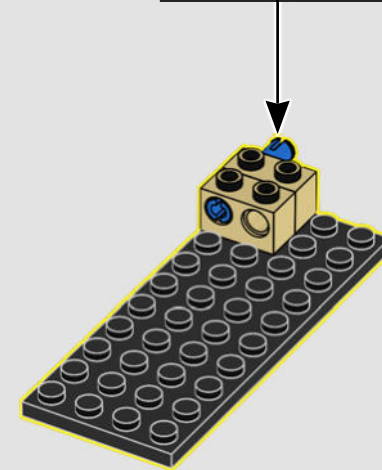
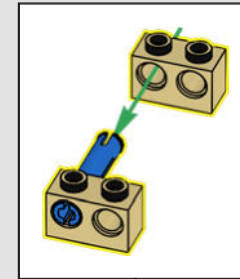

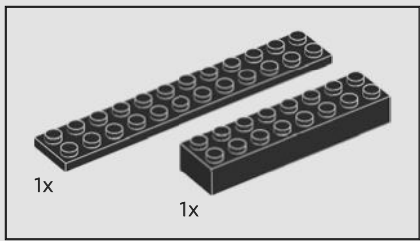

247

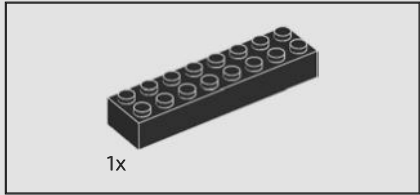
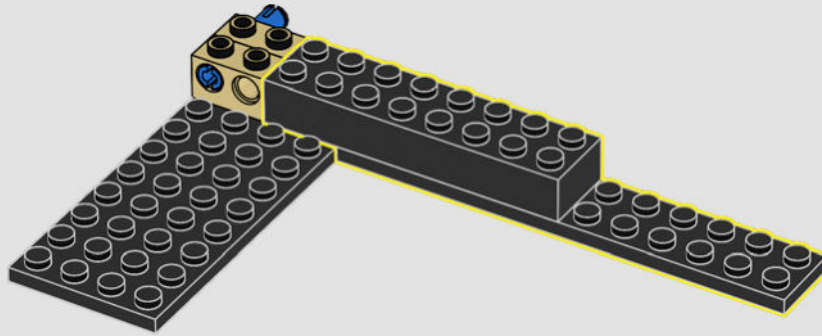

248

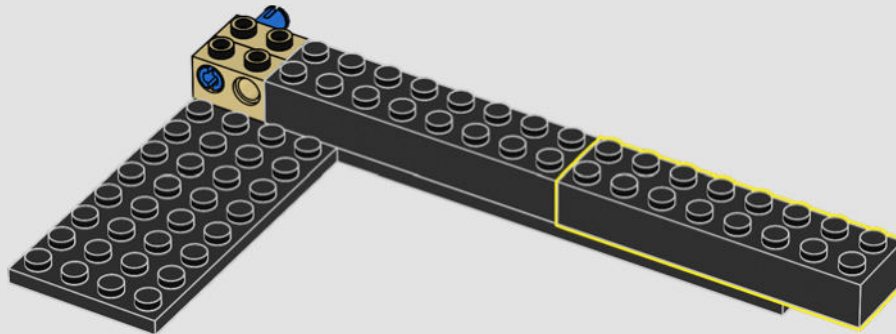

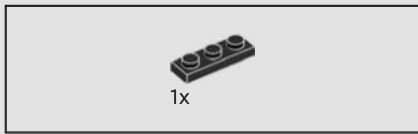

249

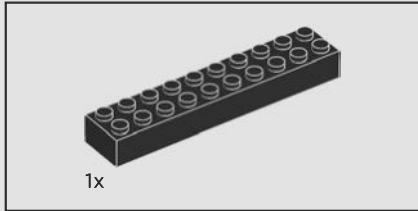
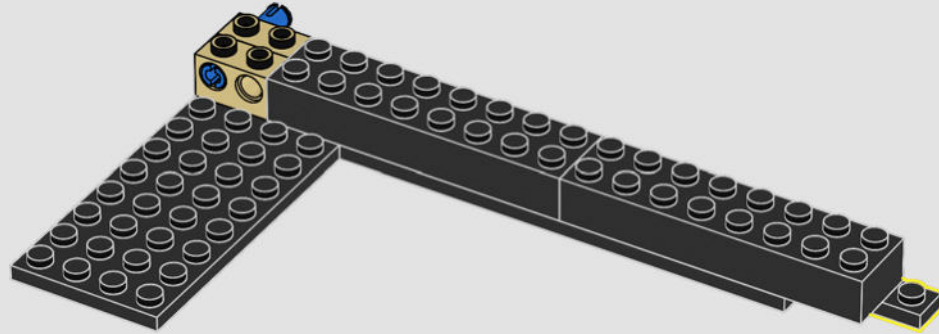

250

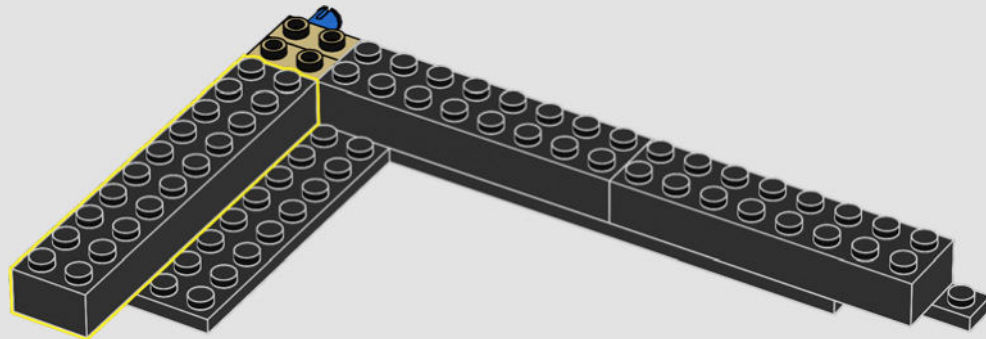

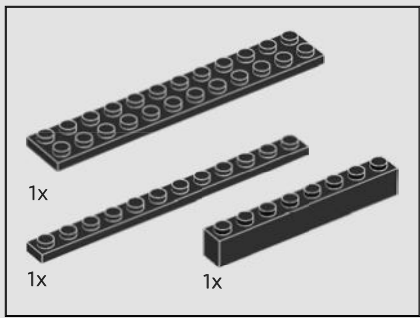

251

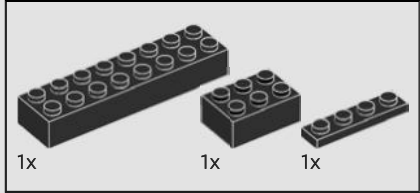
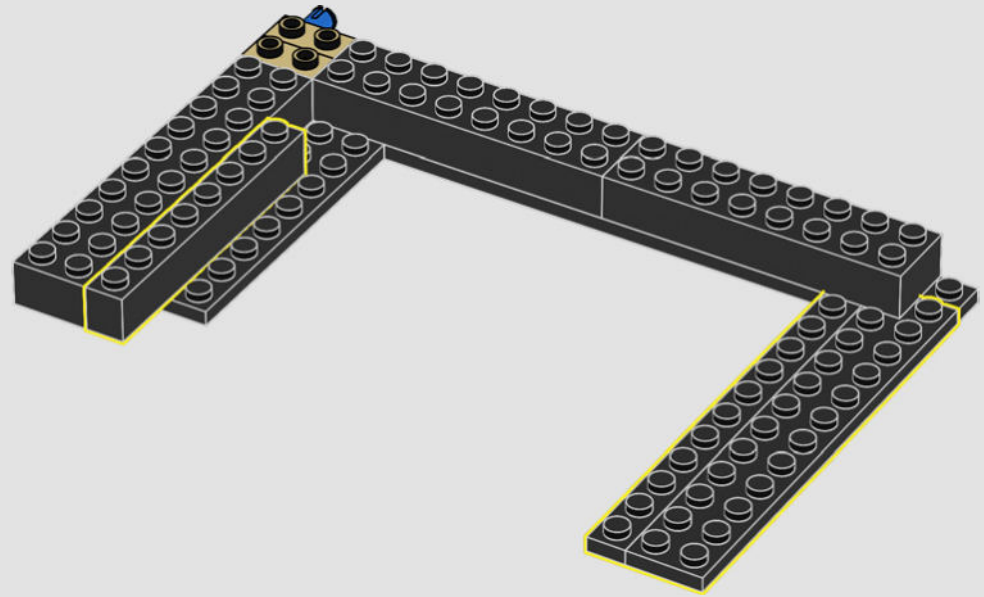

252

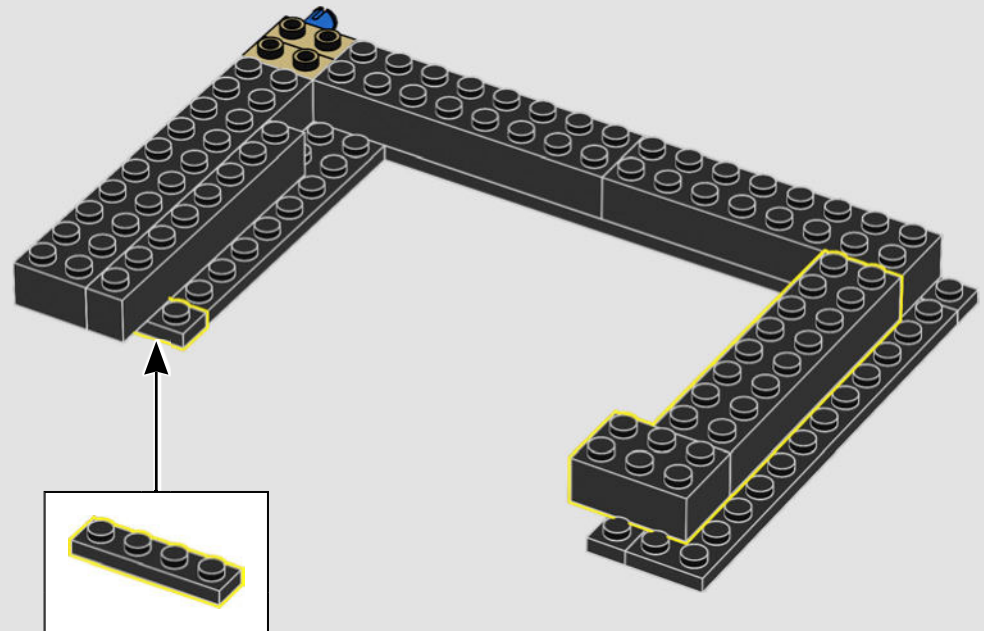

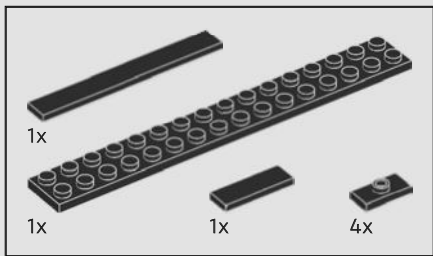

253

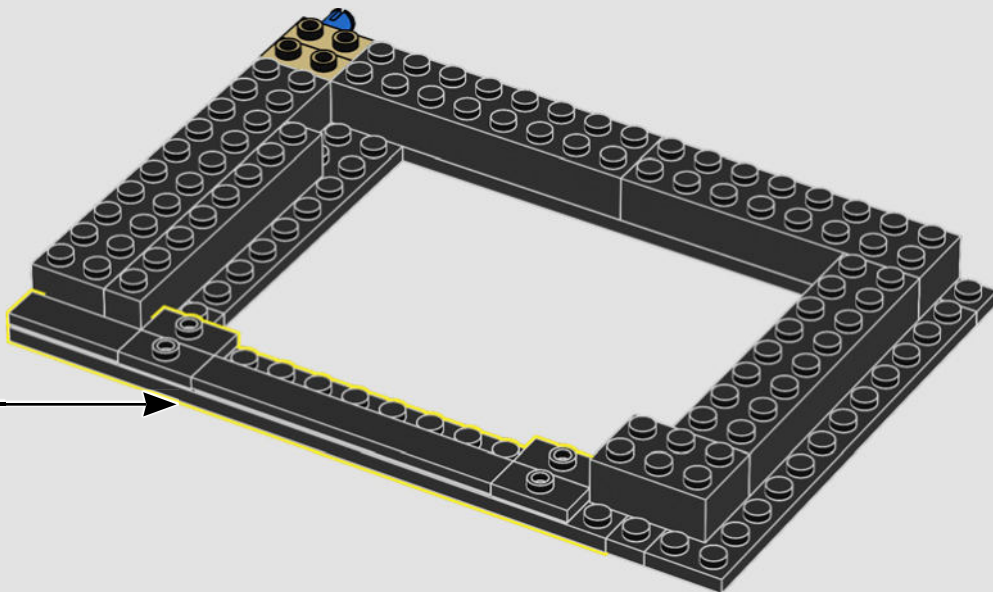
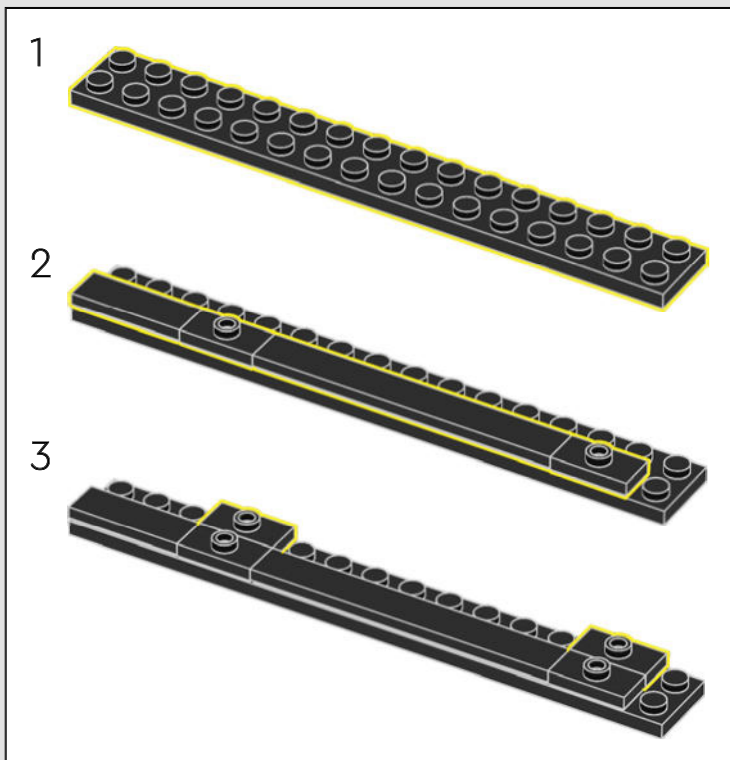

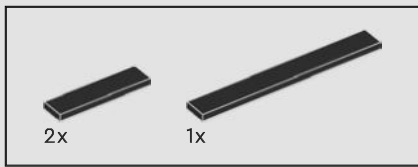

254

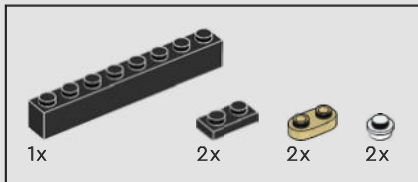
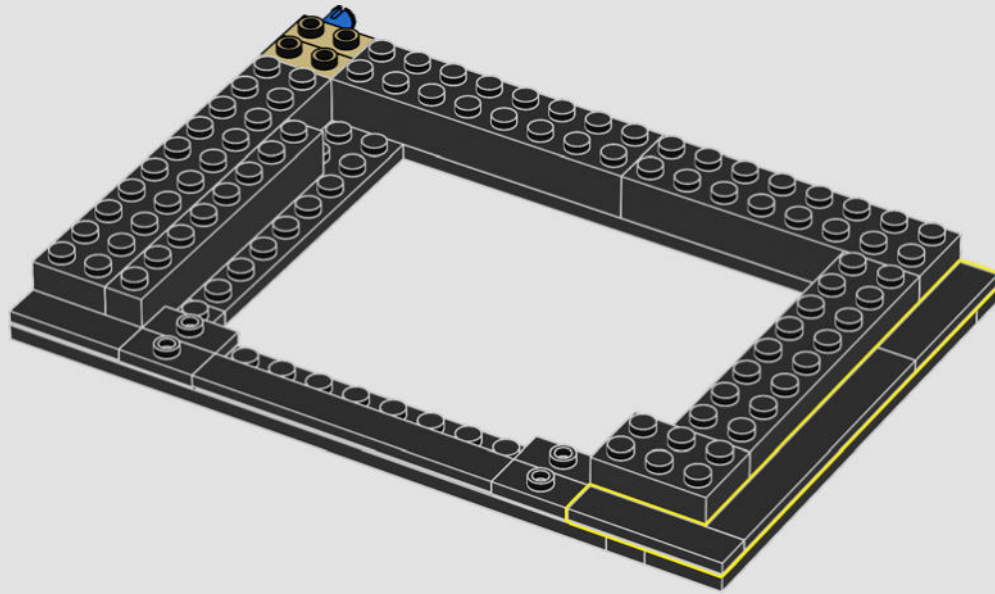

255

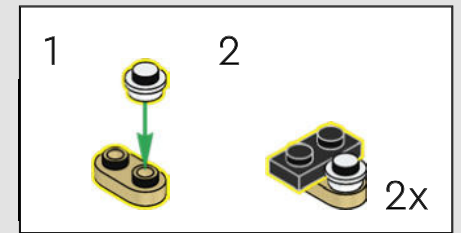
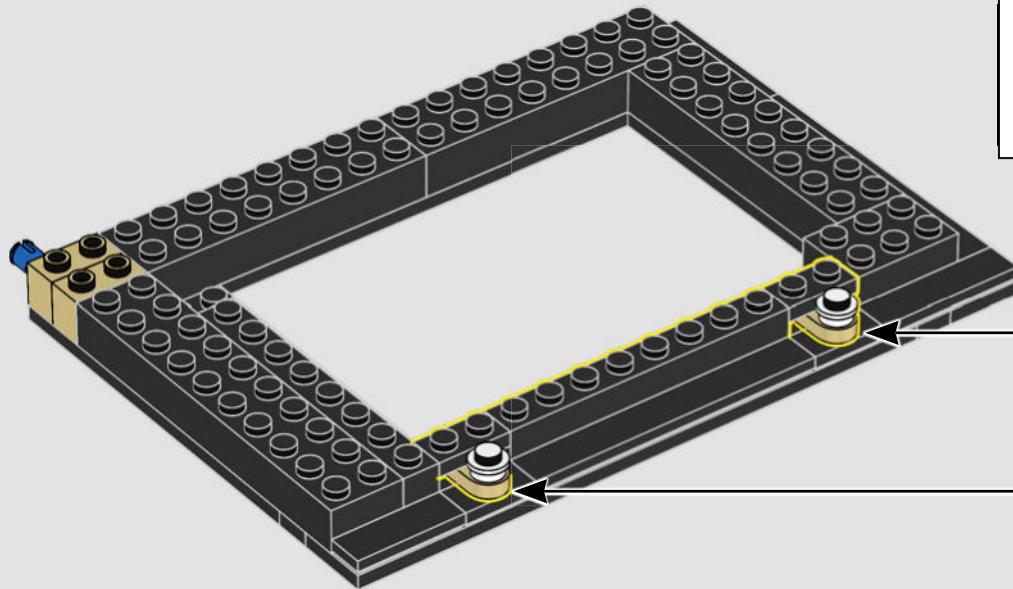

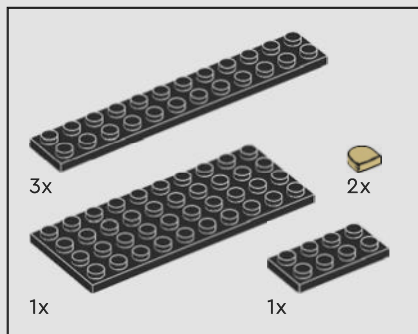

256

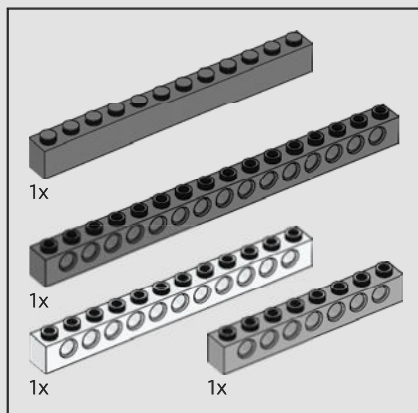
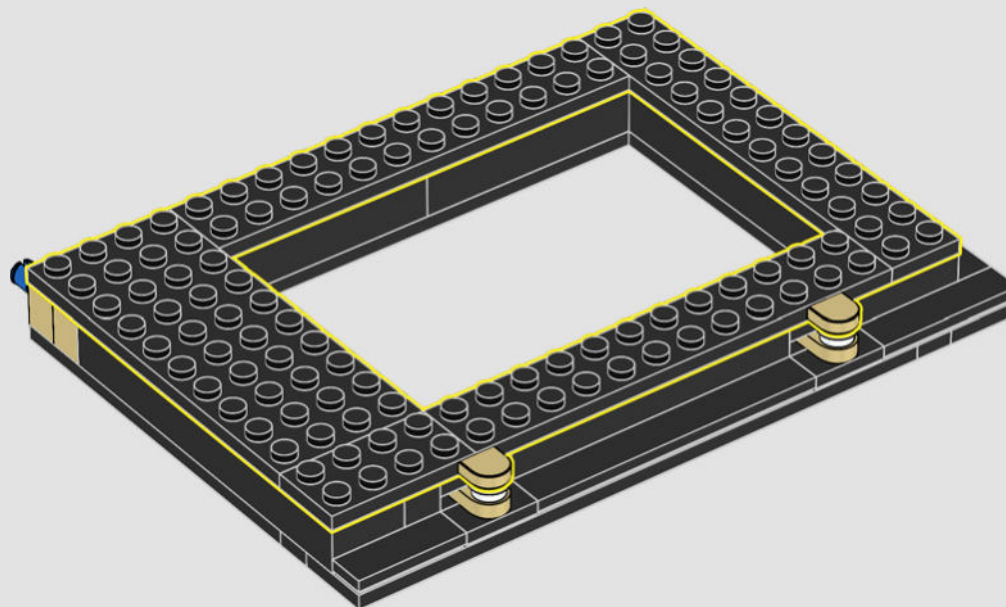

257

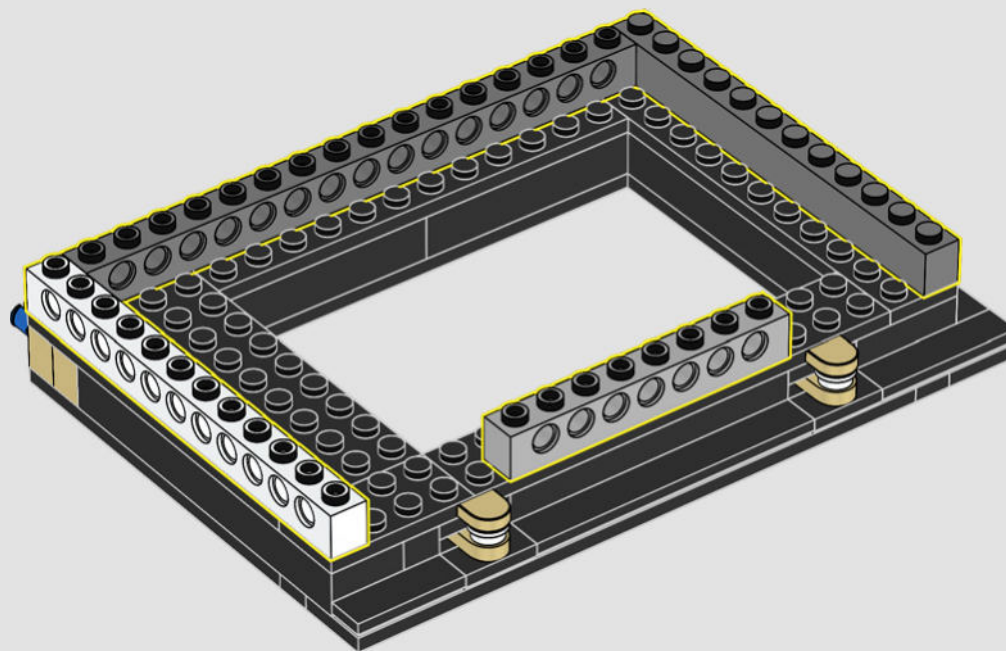

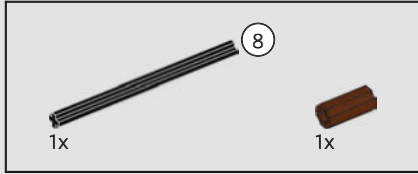
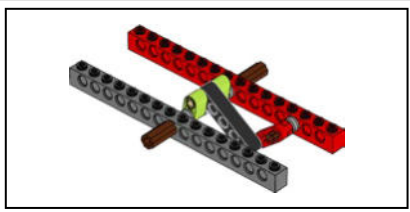

258

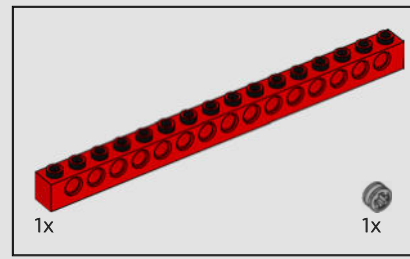
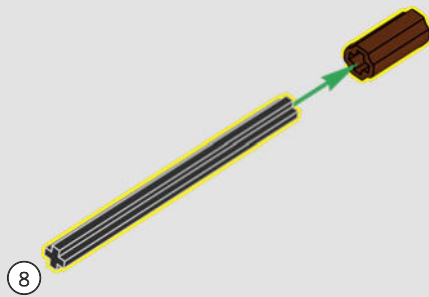

259

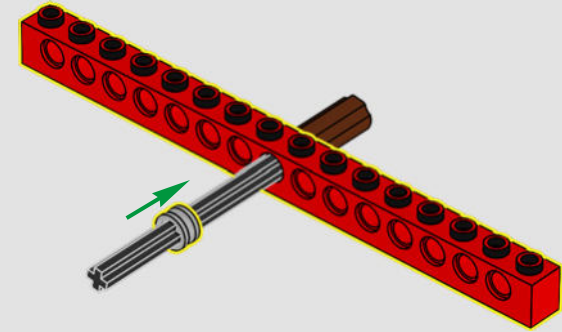

260

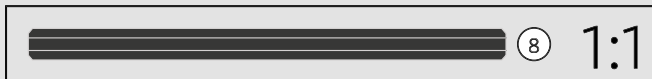
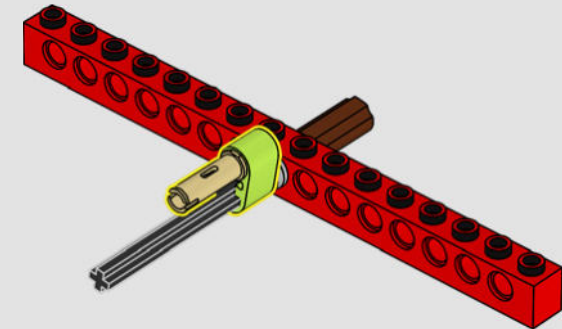

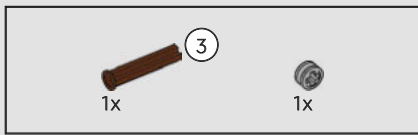

261

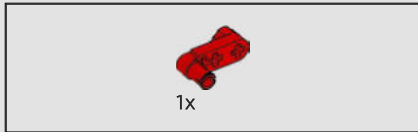
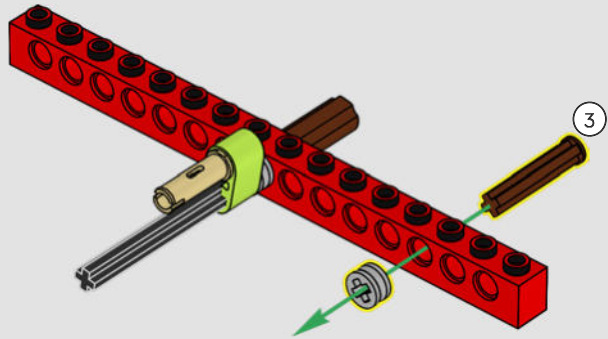

262

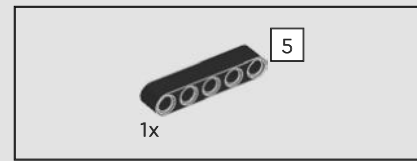
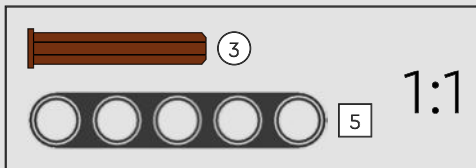
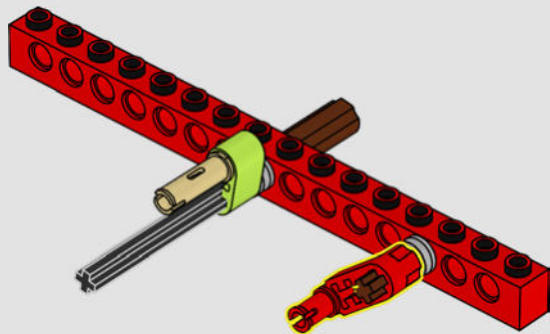

263

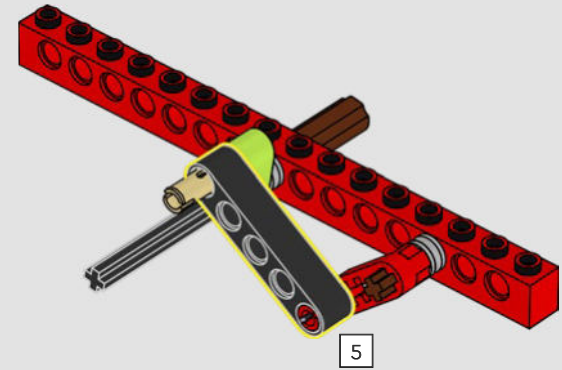

264



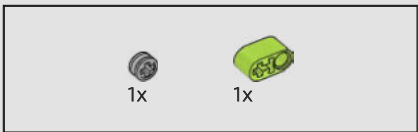

265

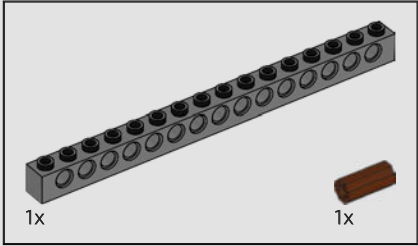
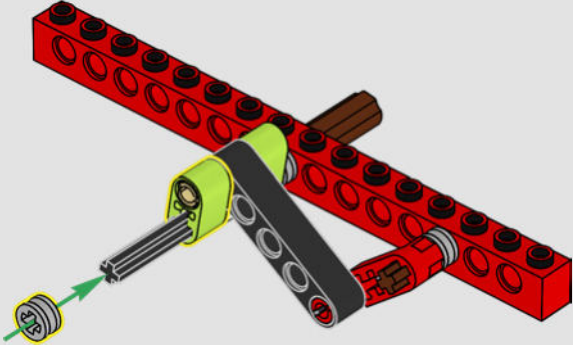

266

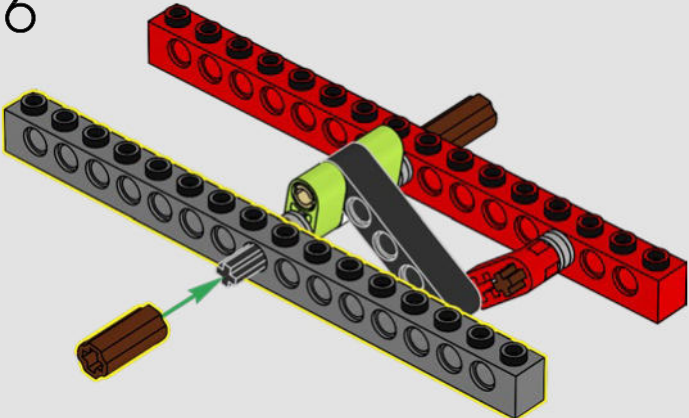

267

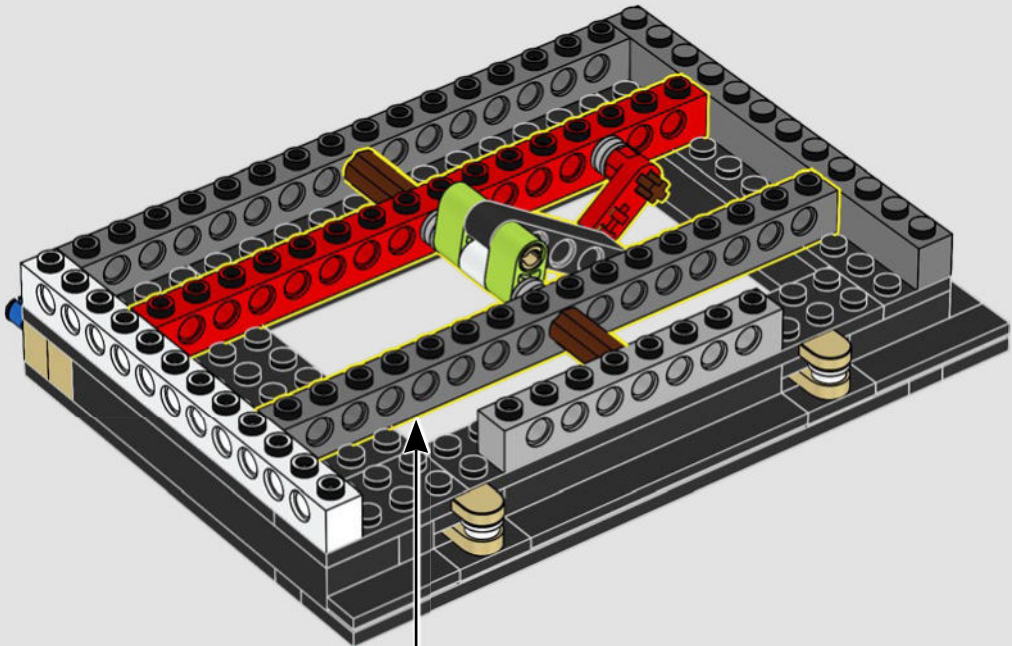

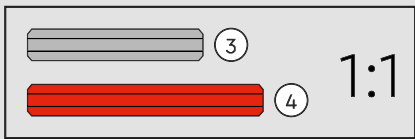
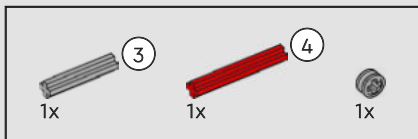

268

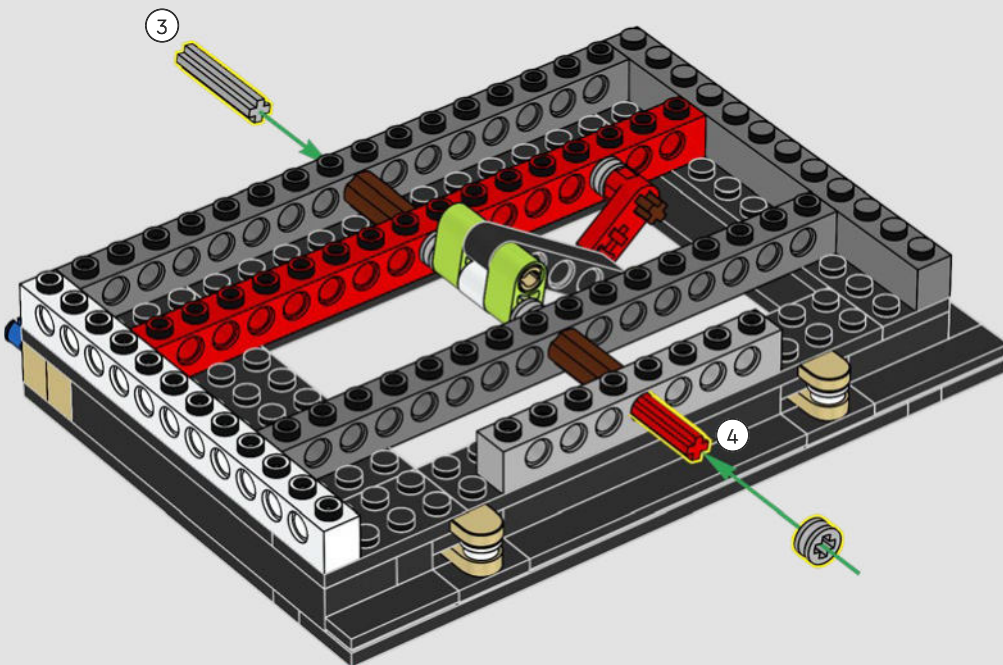



1x

269

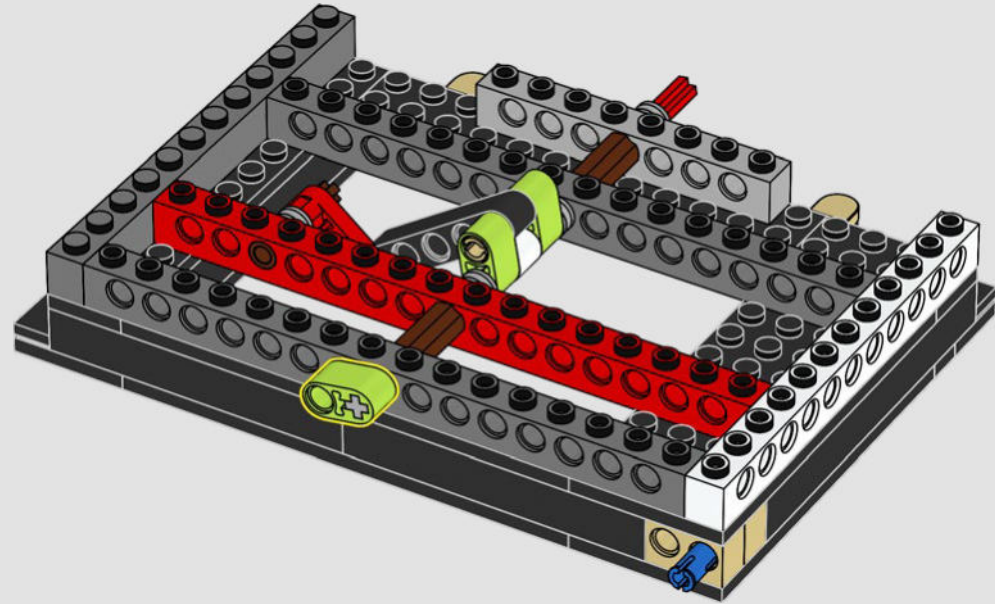

1x



1x



1x

270

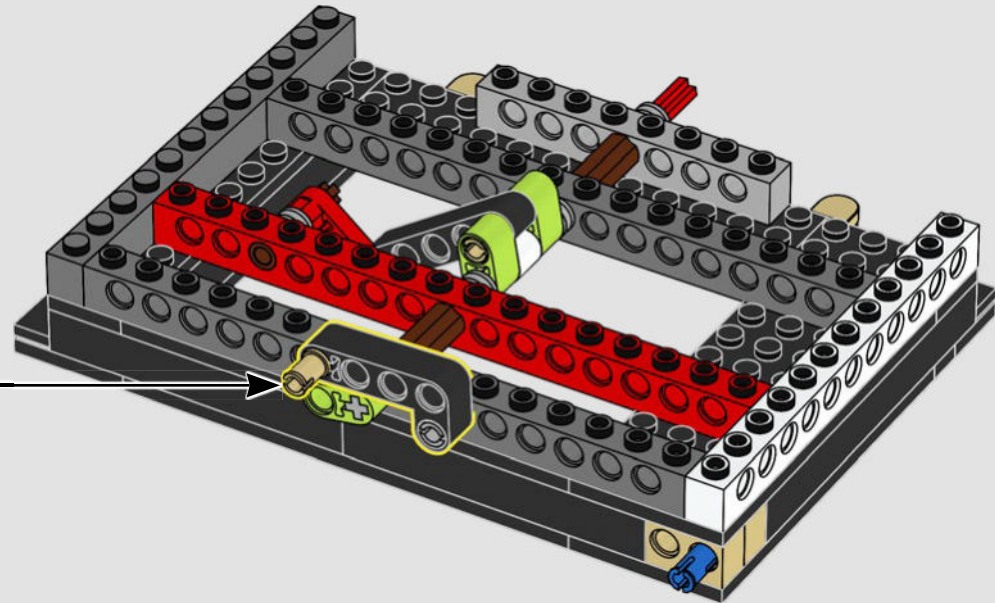
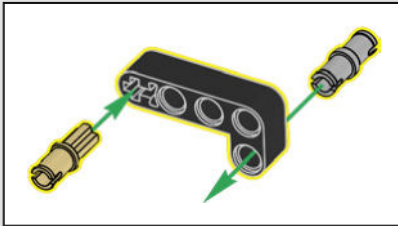



271

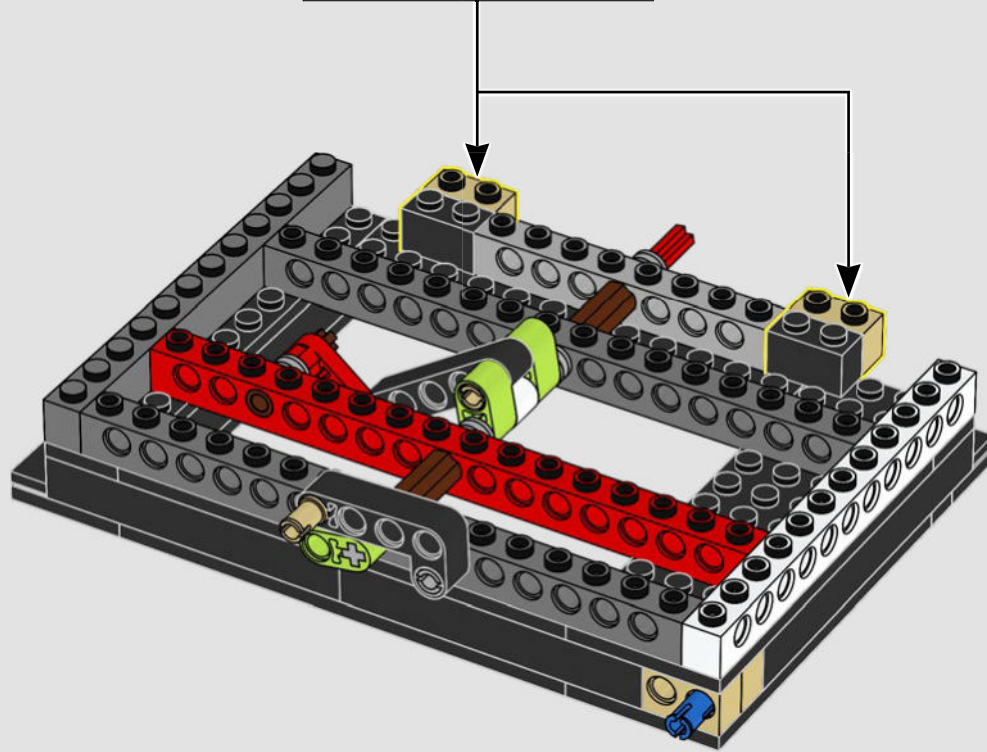
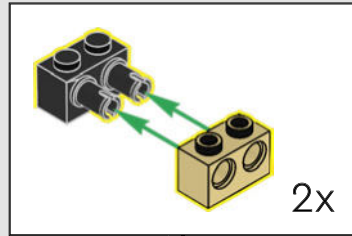

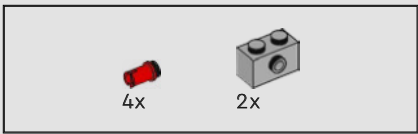

272

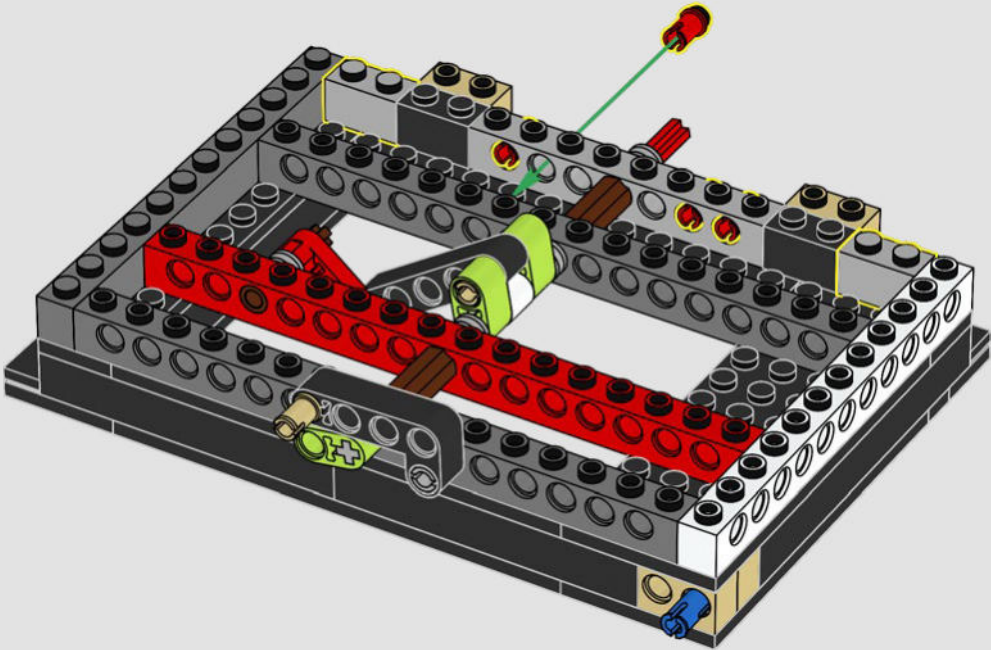

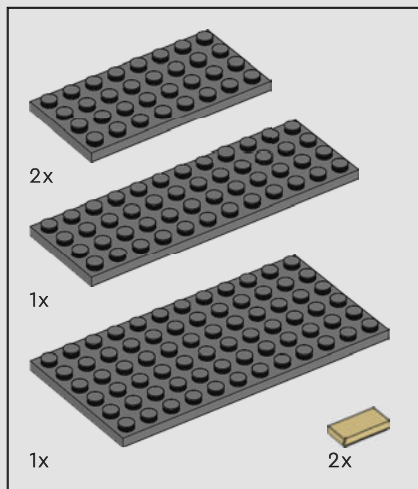

273

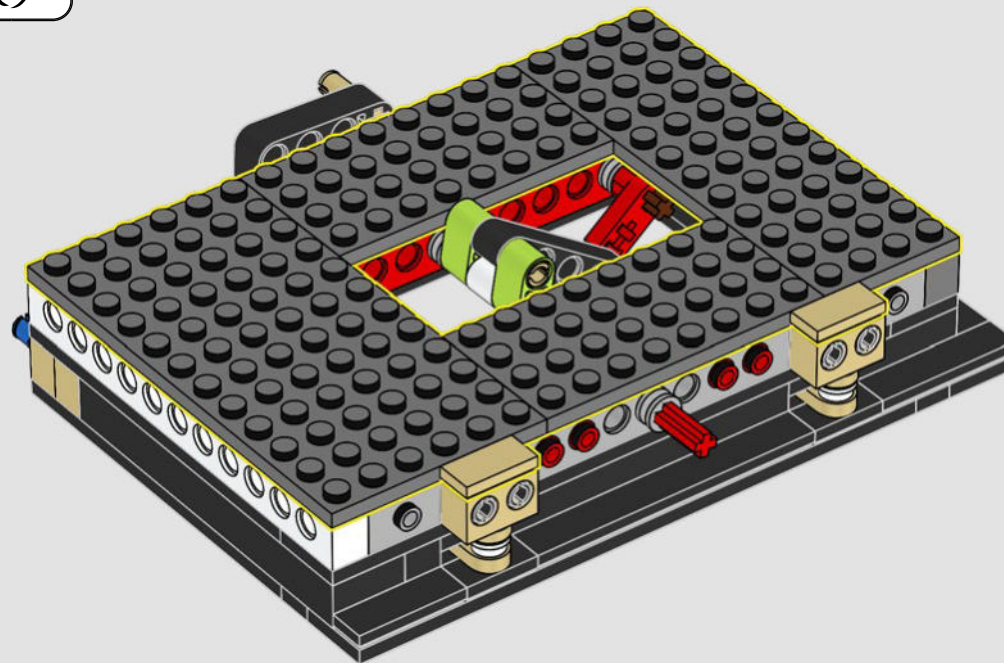
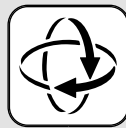



274

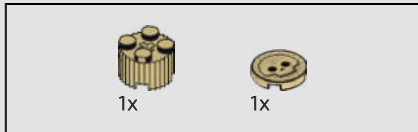
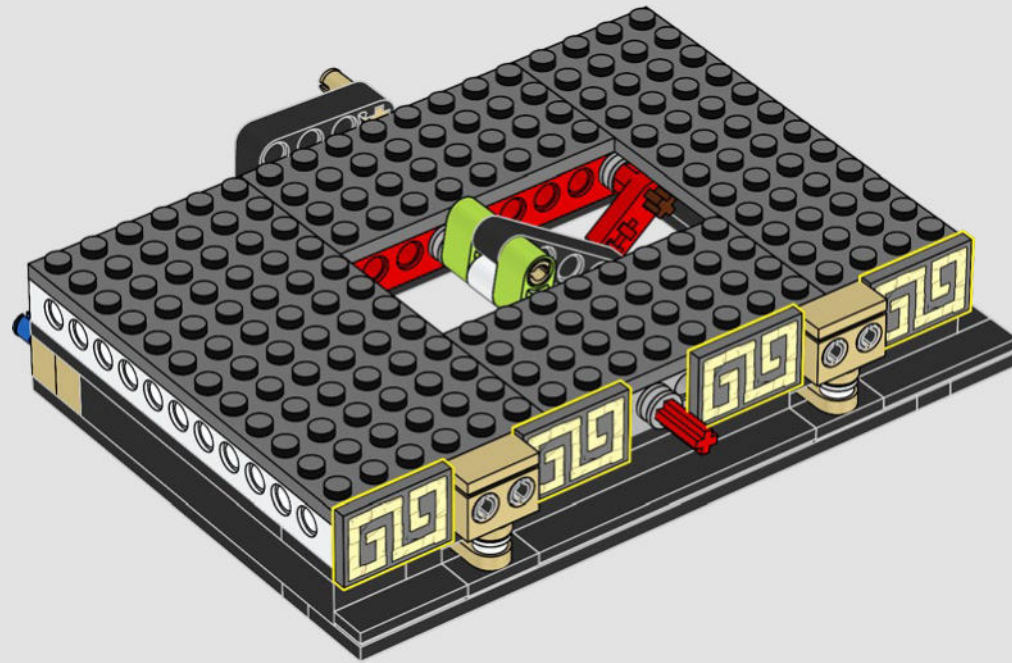

275

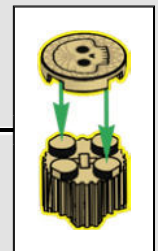
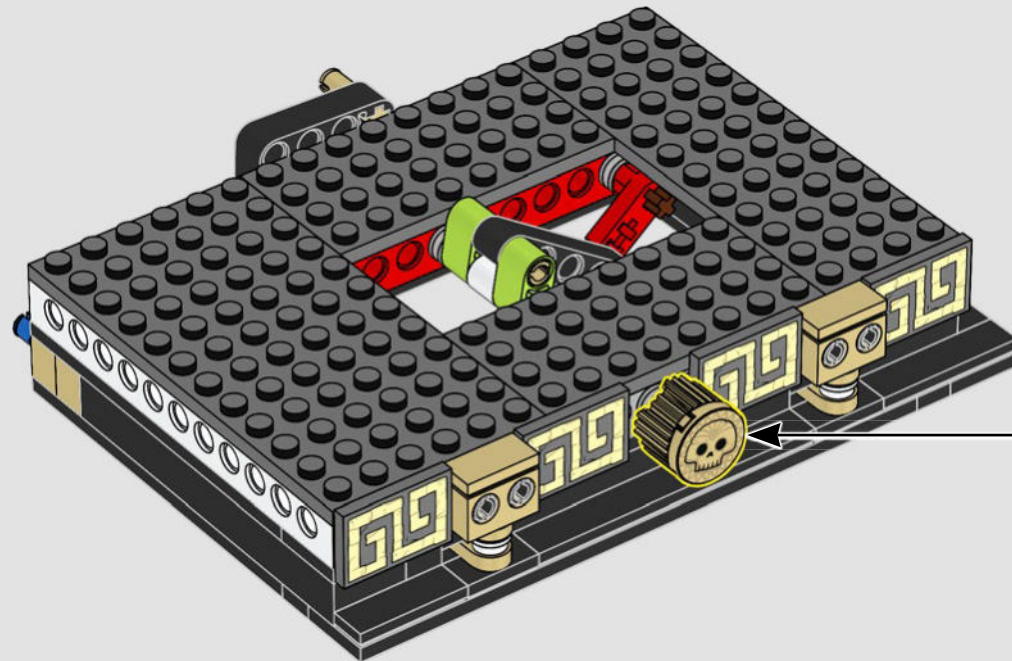

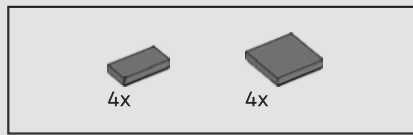

276

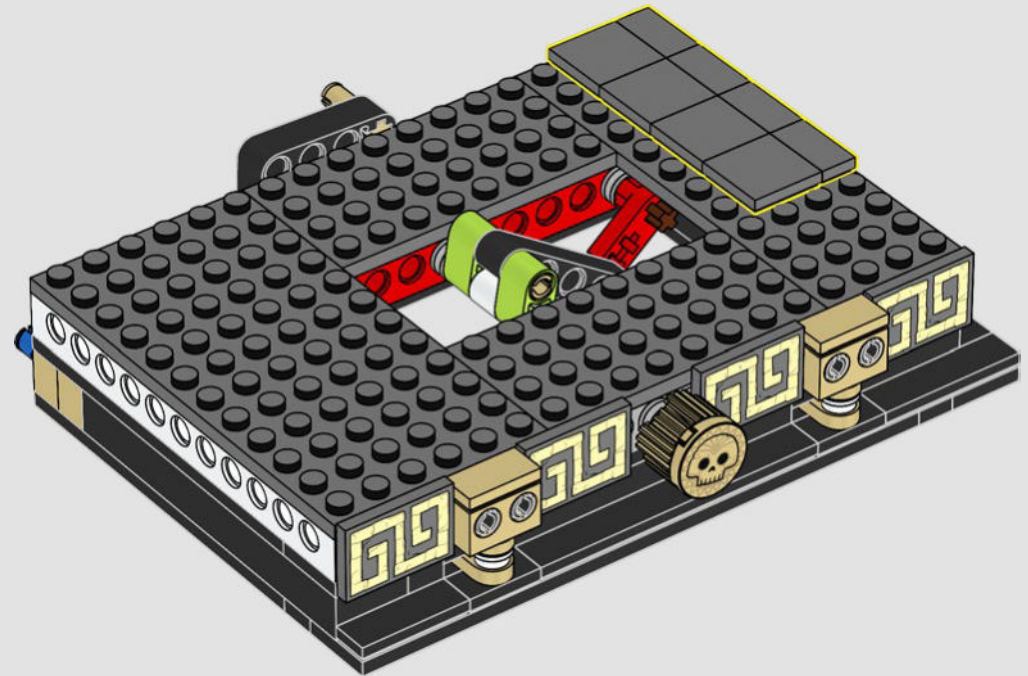

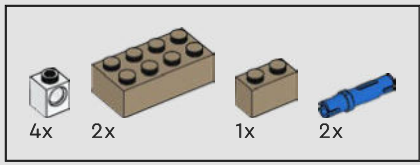

277

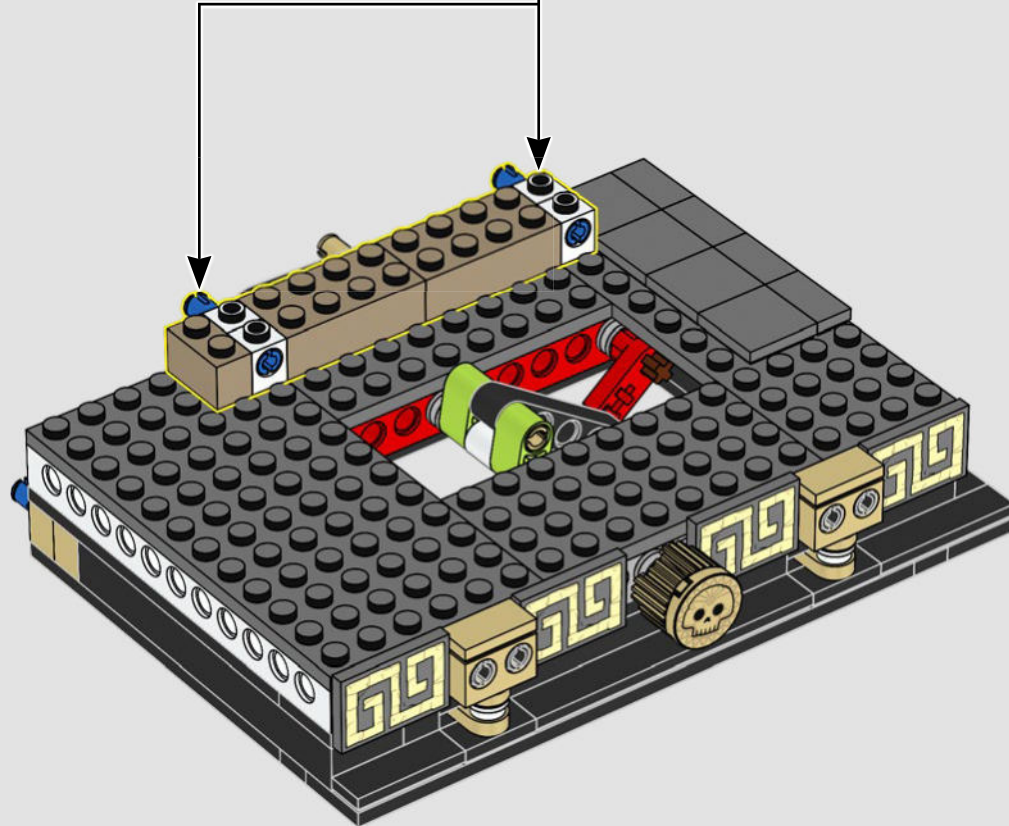
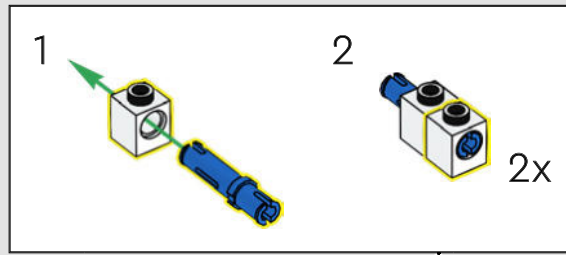

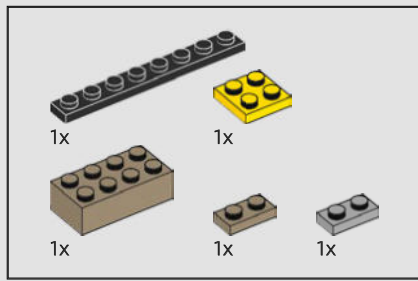

278

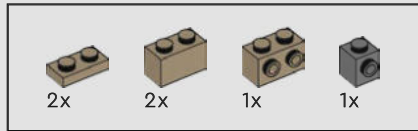
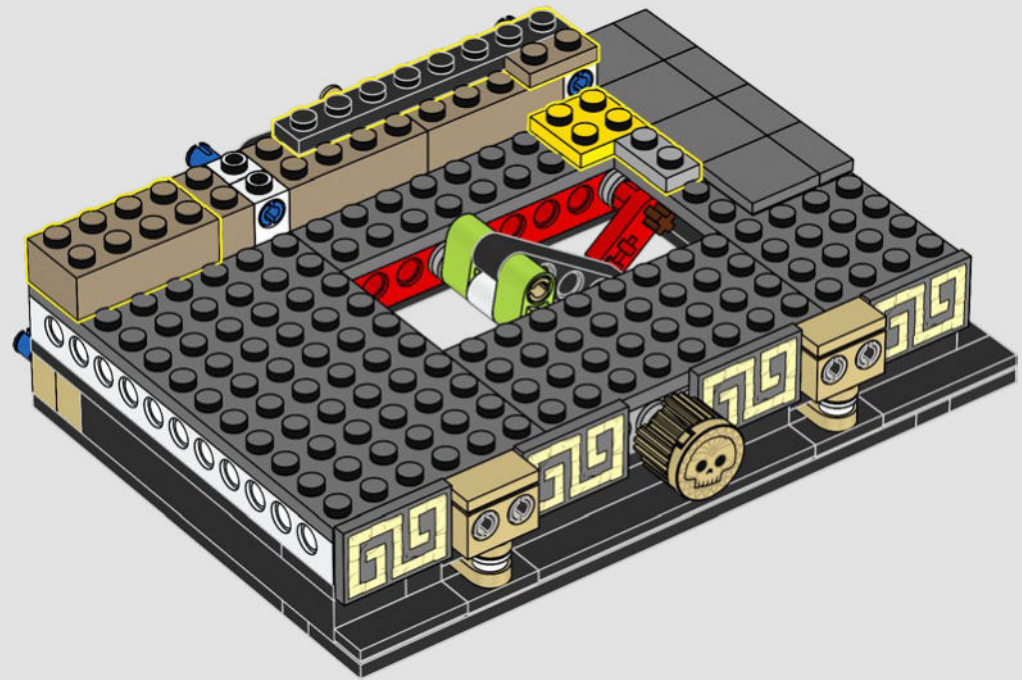

279

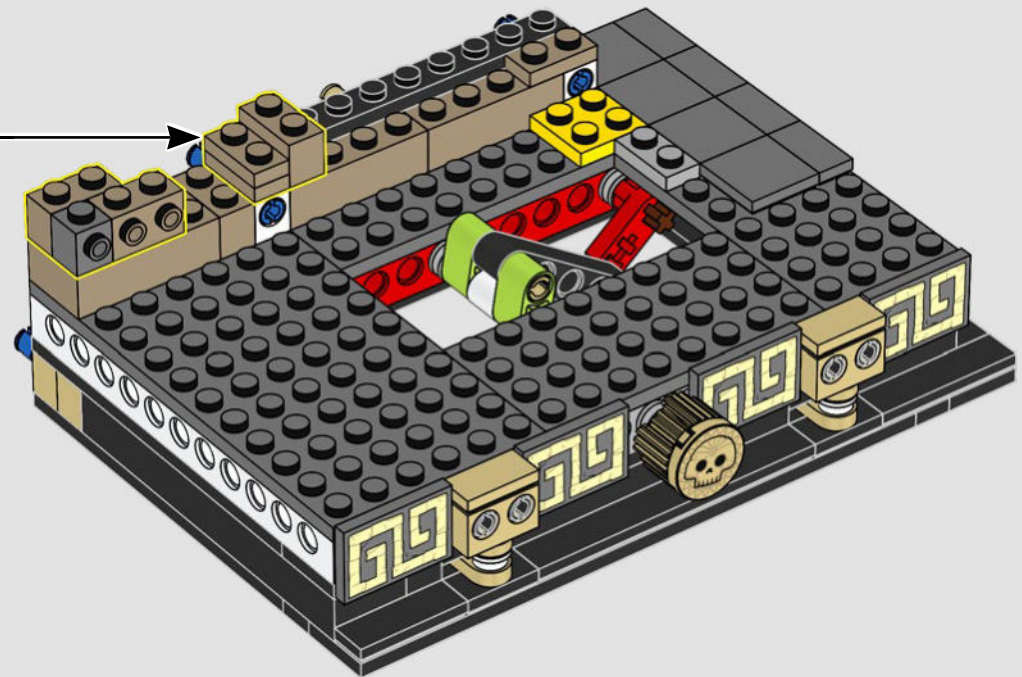
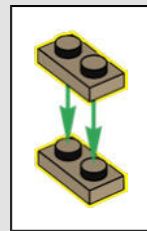

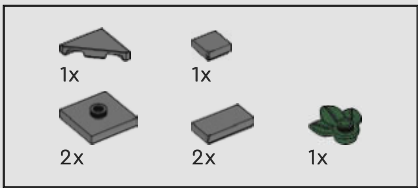

280

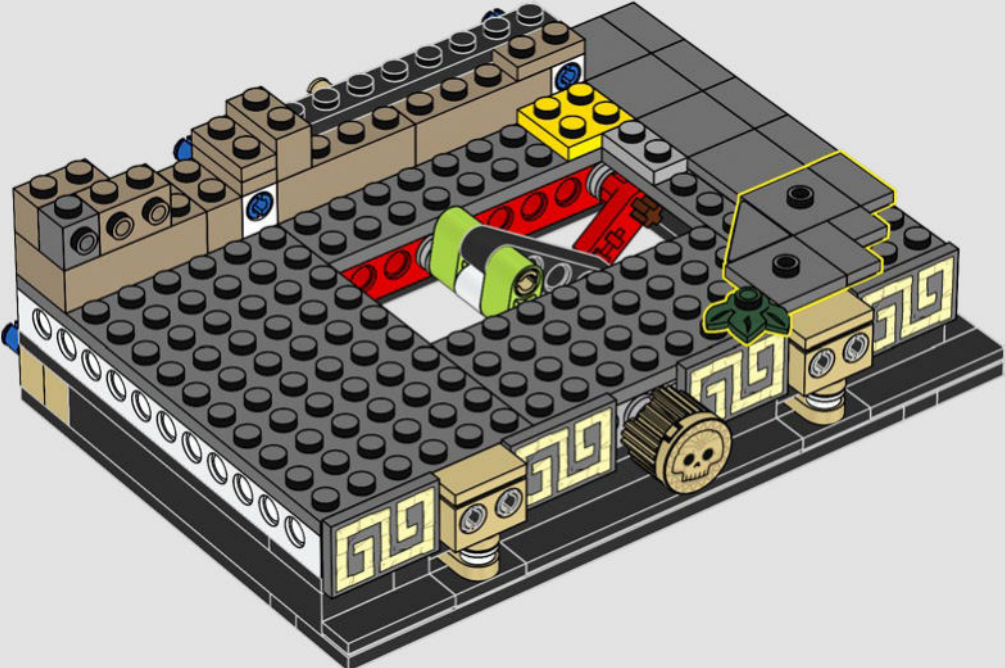

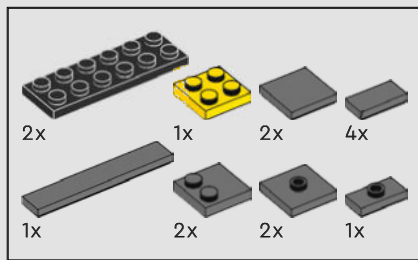

281

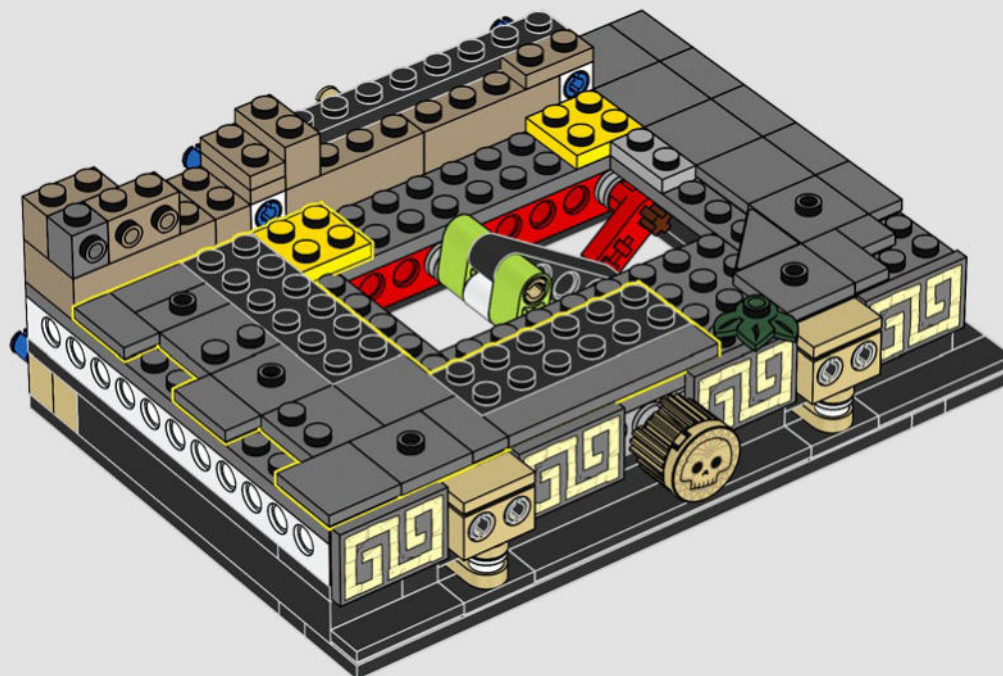

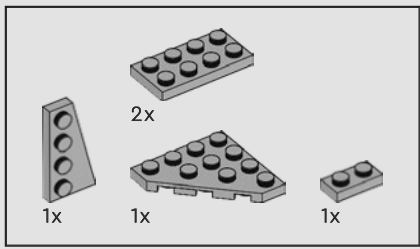

282

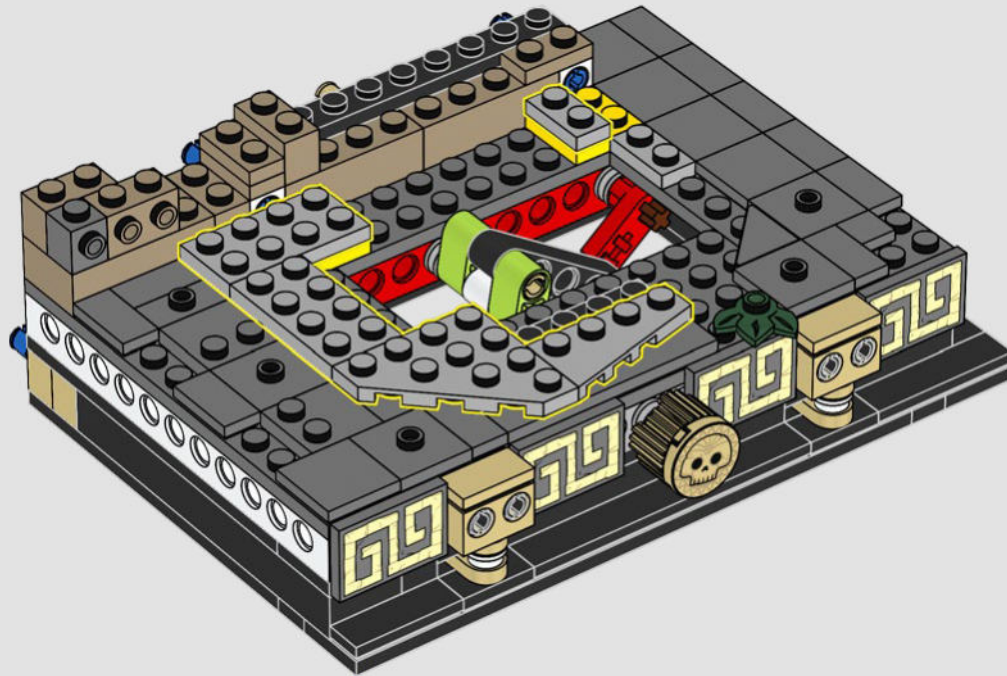

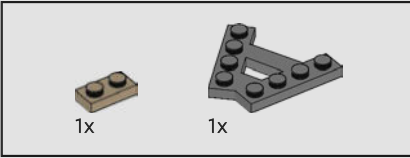
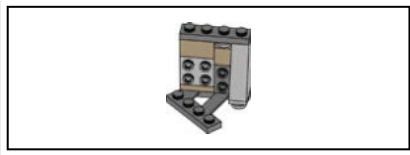

283

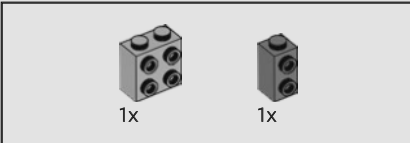
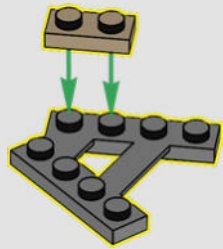

284

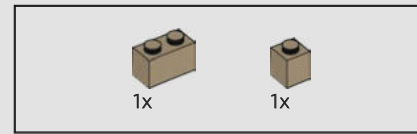
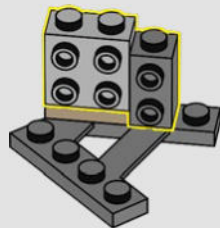

285

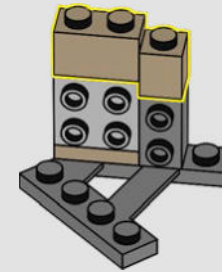

286

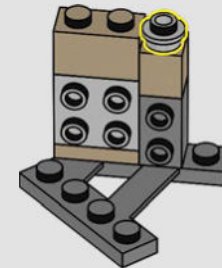

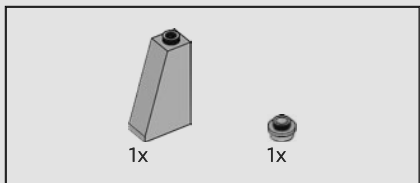

287

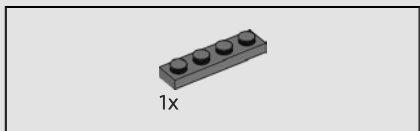
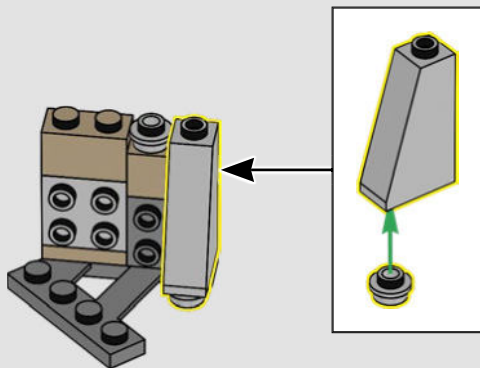

288

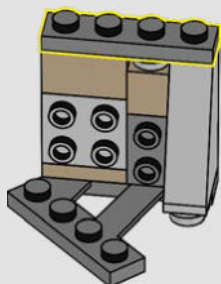

289

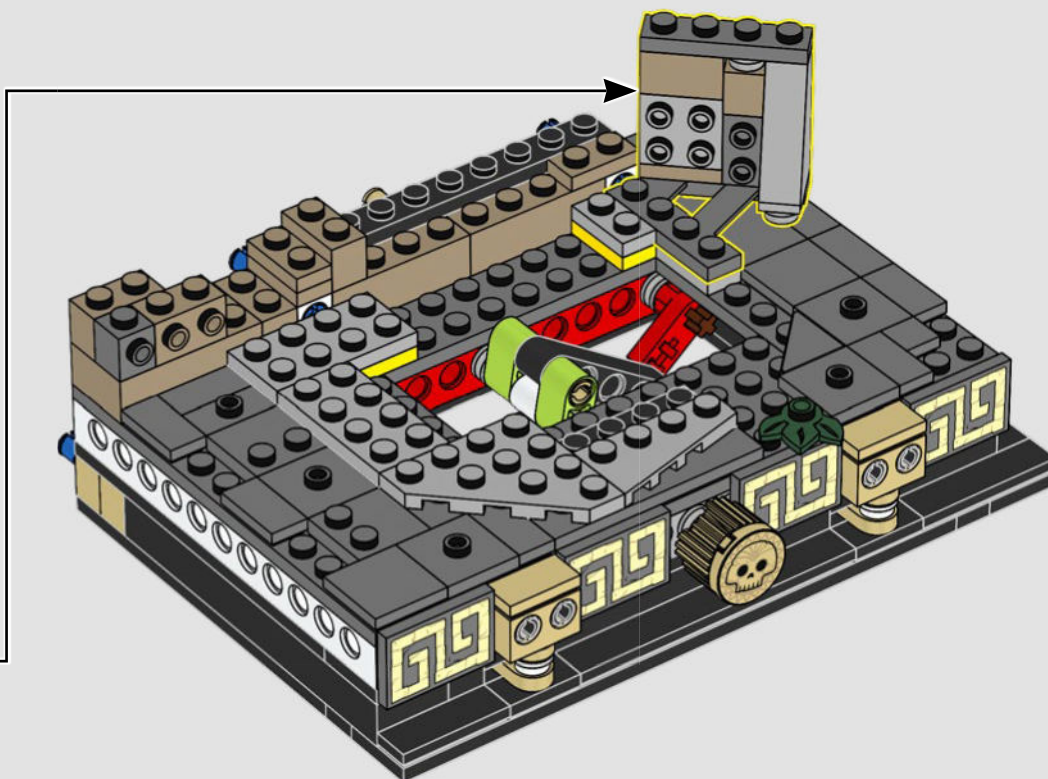

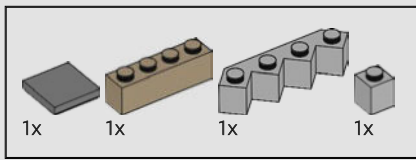

290

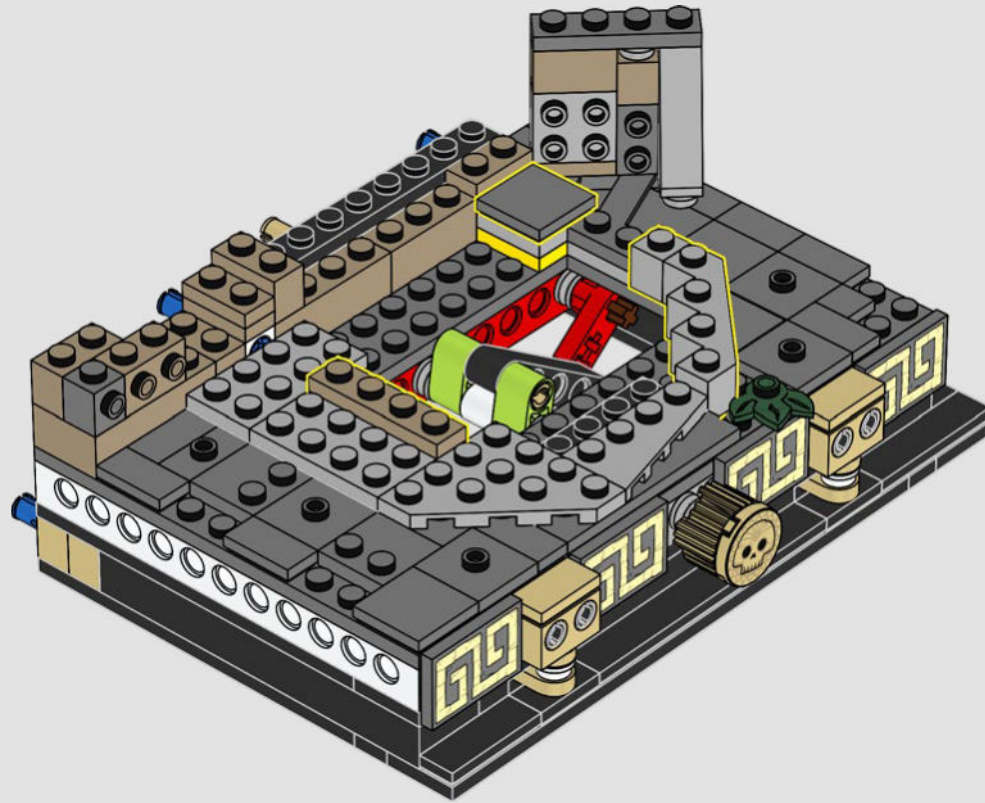

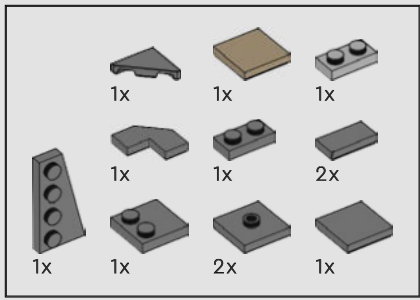

291

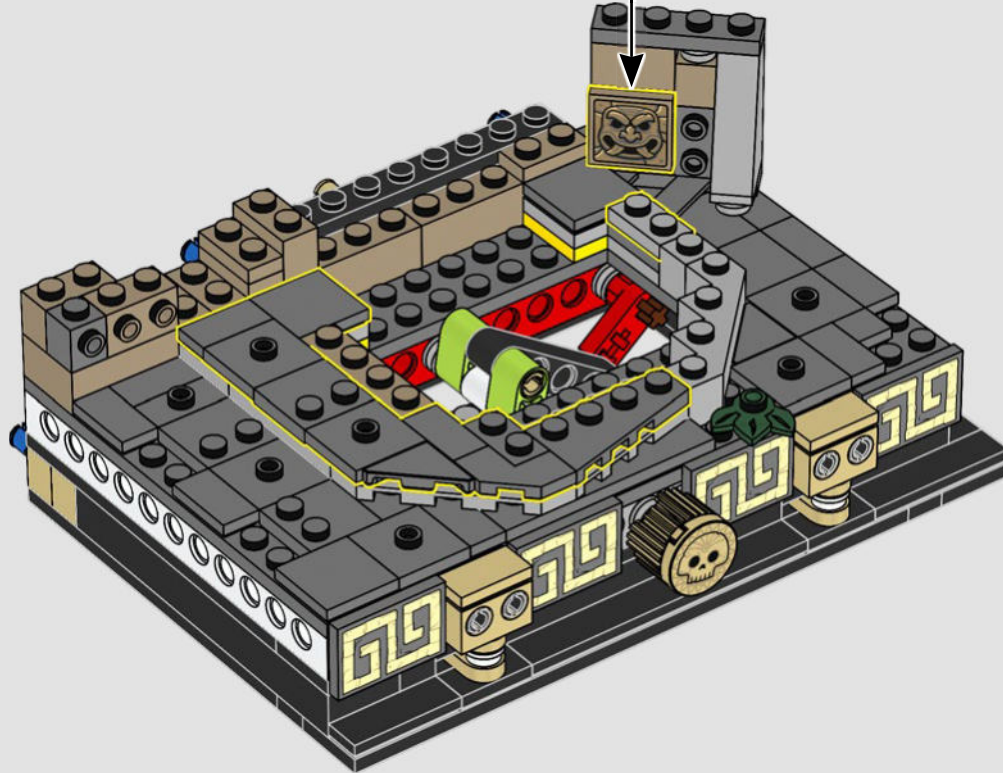

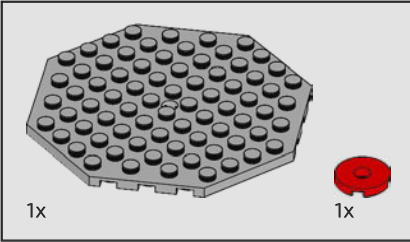
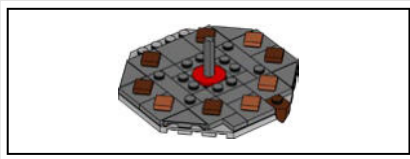

292

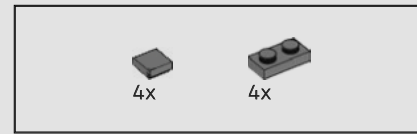
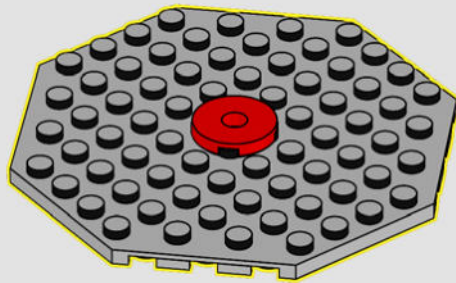

293

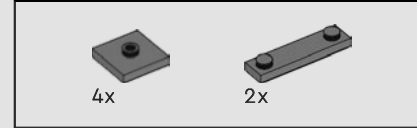
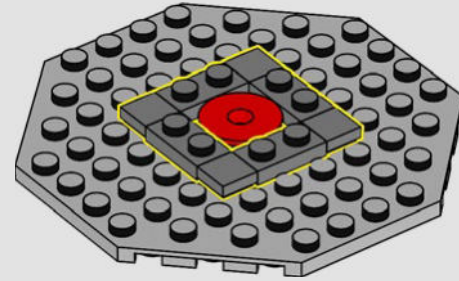

294

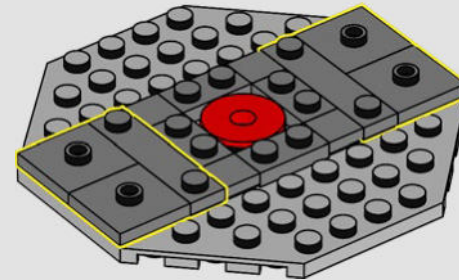

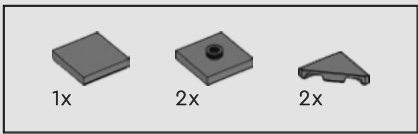

295

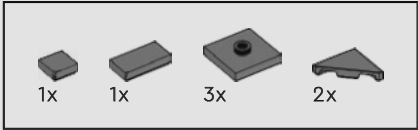
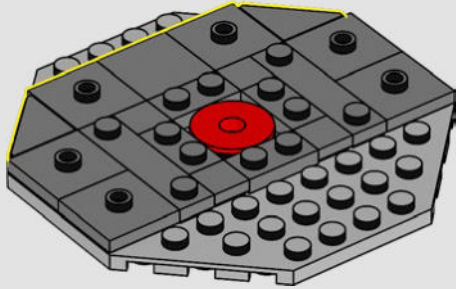

296

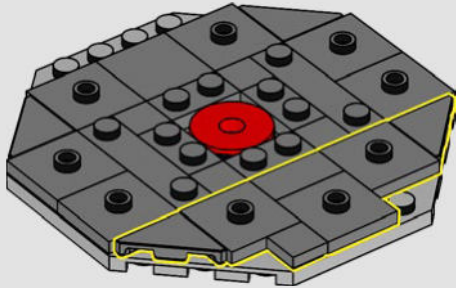

297

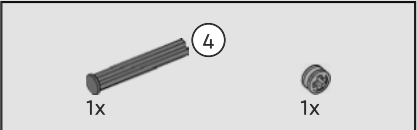
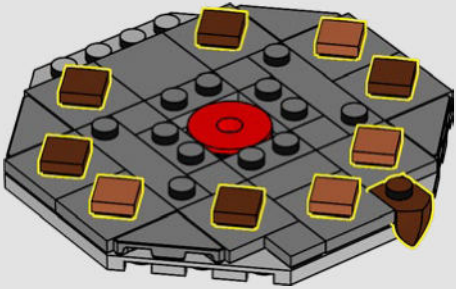

298

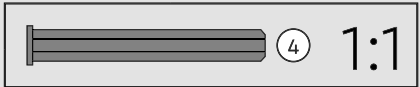
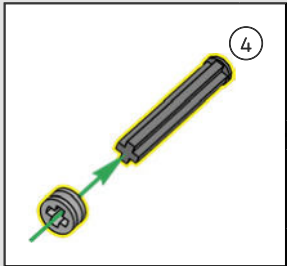
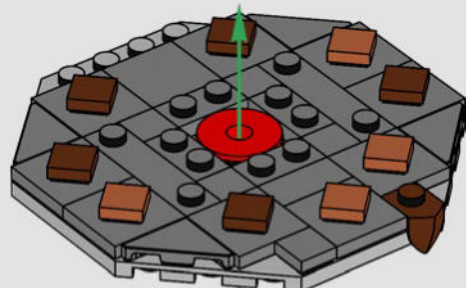

299

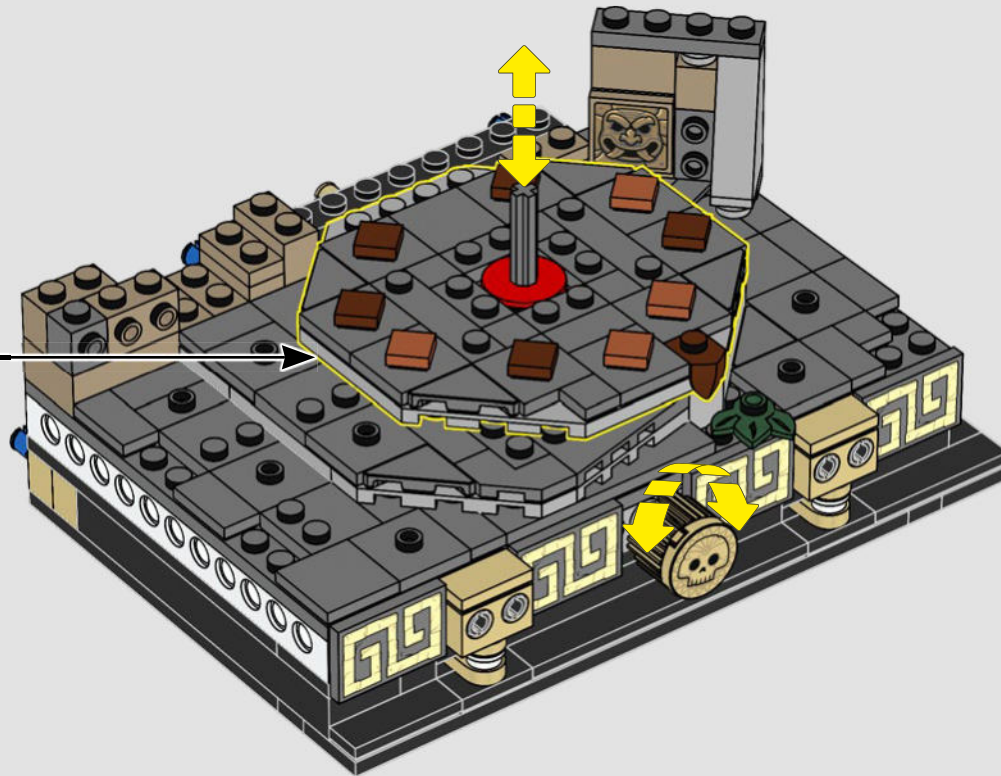

		
3x	5x	1x

300

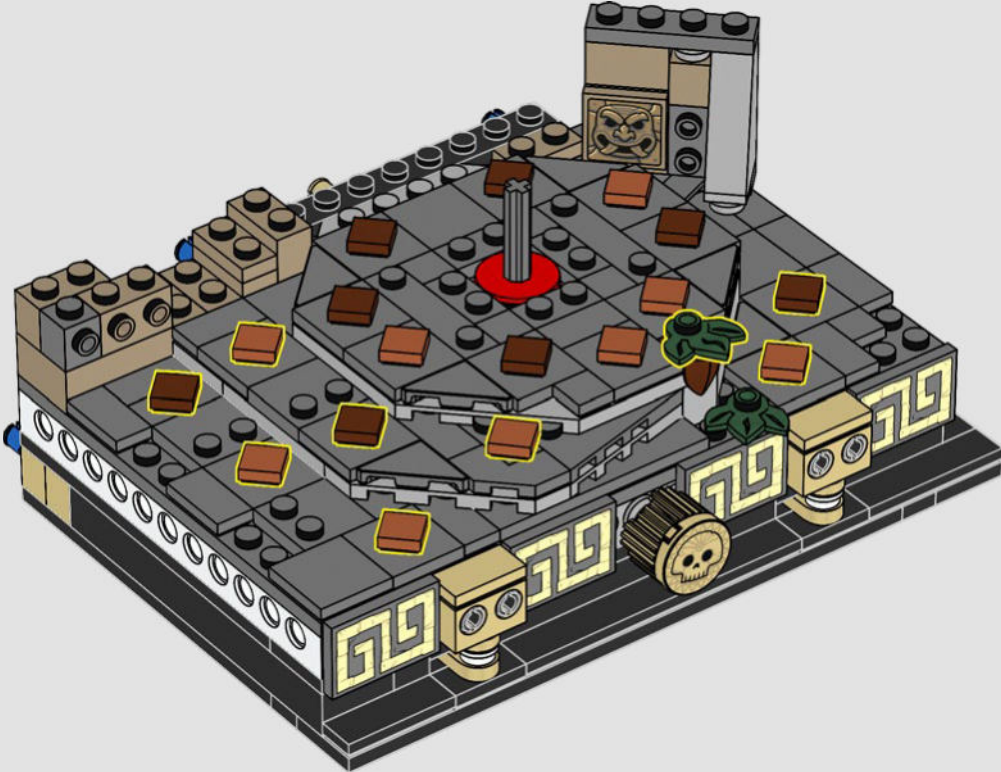

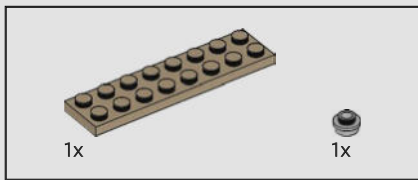

301

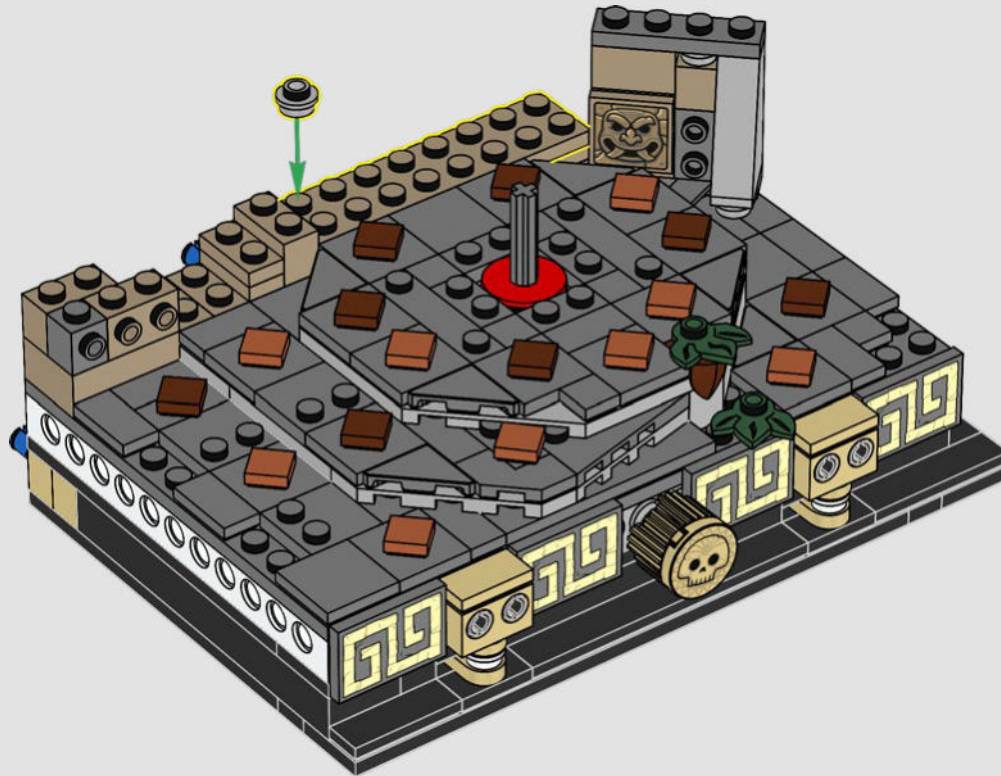

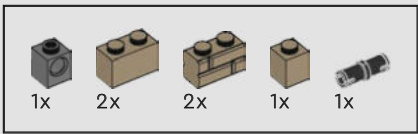

302

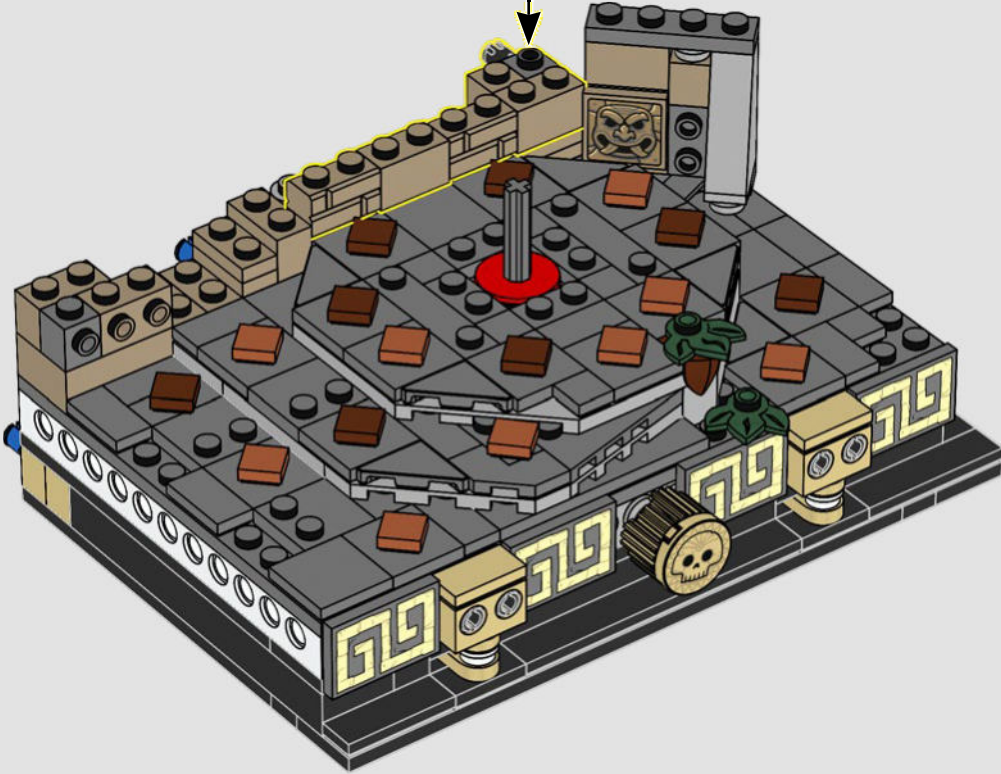
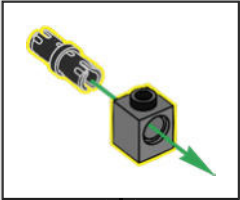

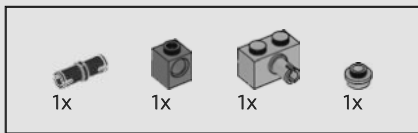

303

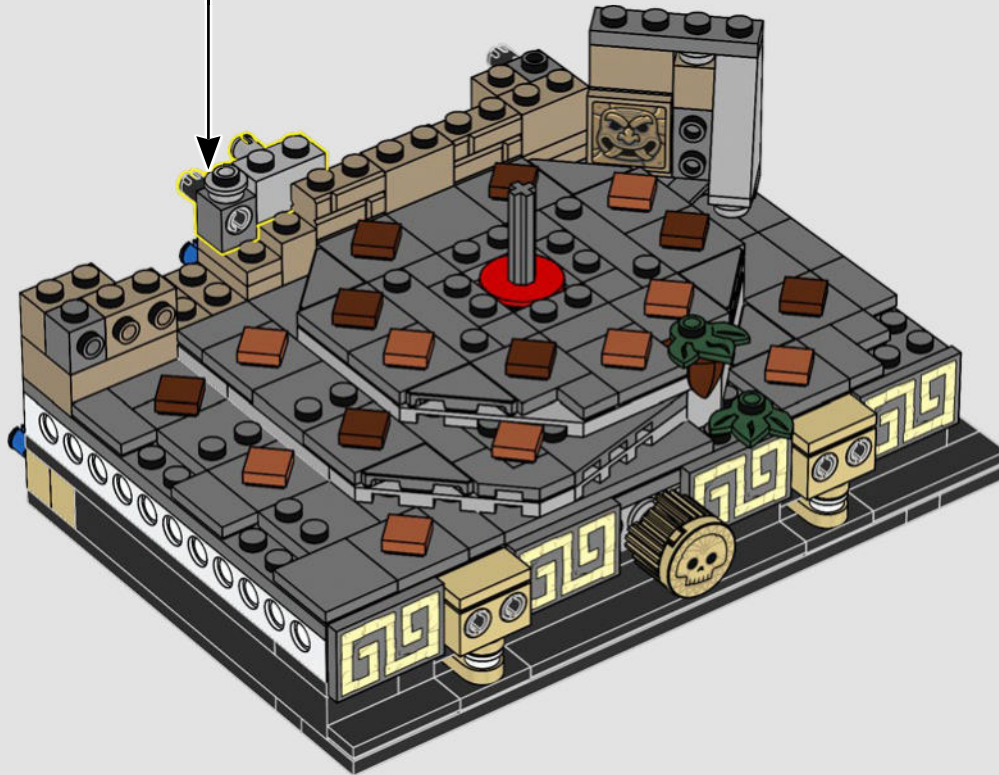
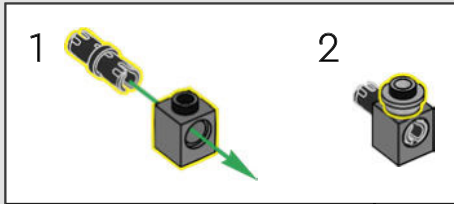



304

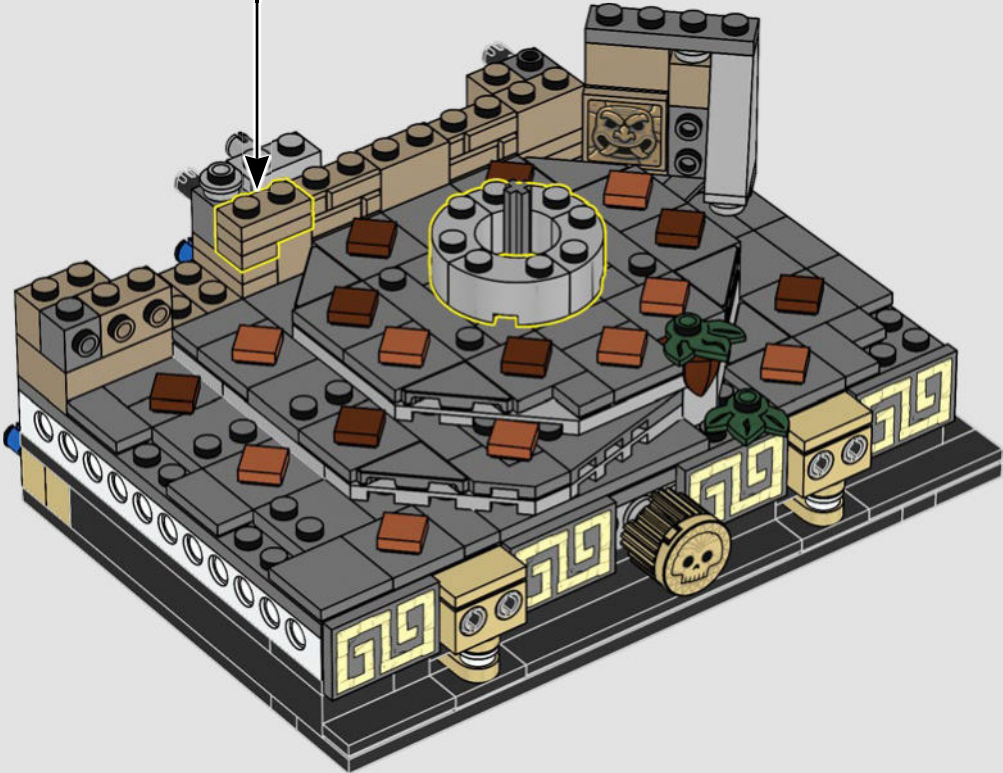
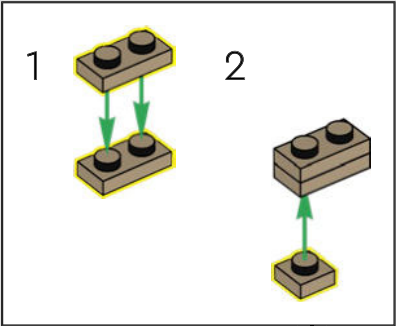

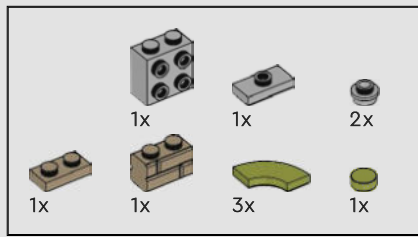

305

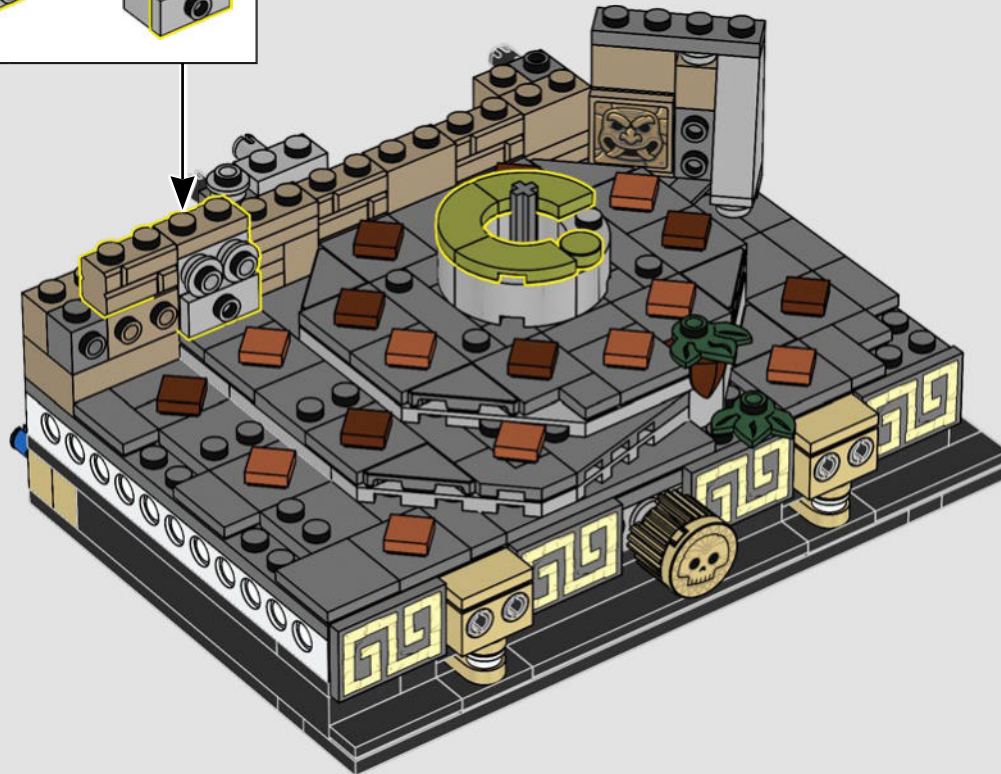
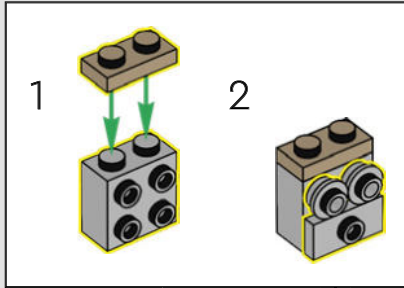

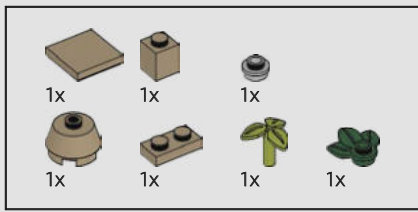

306

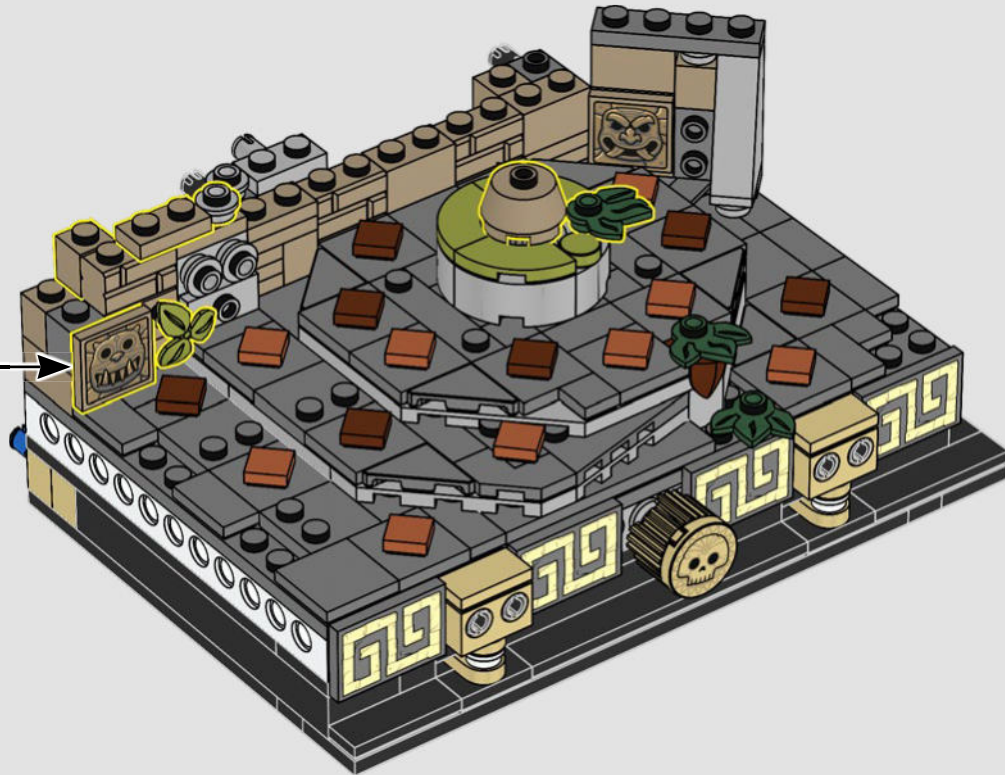
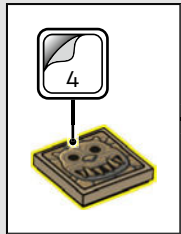

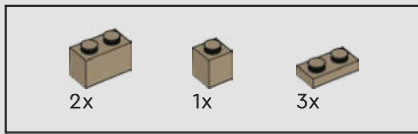

307

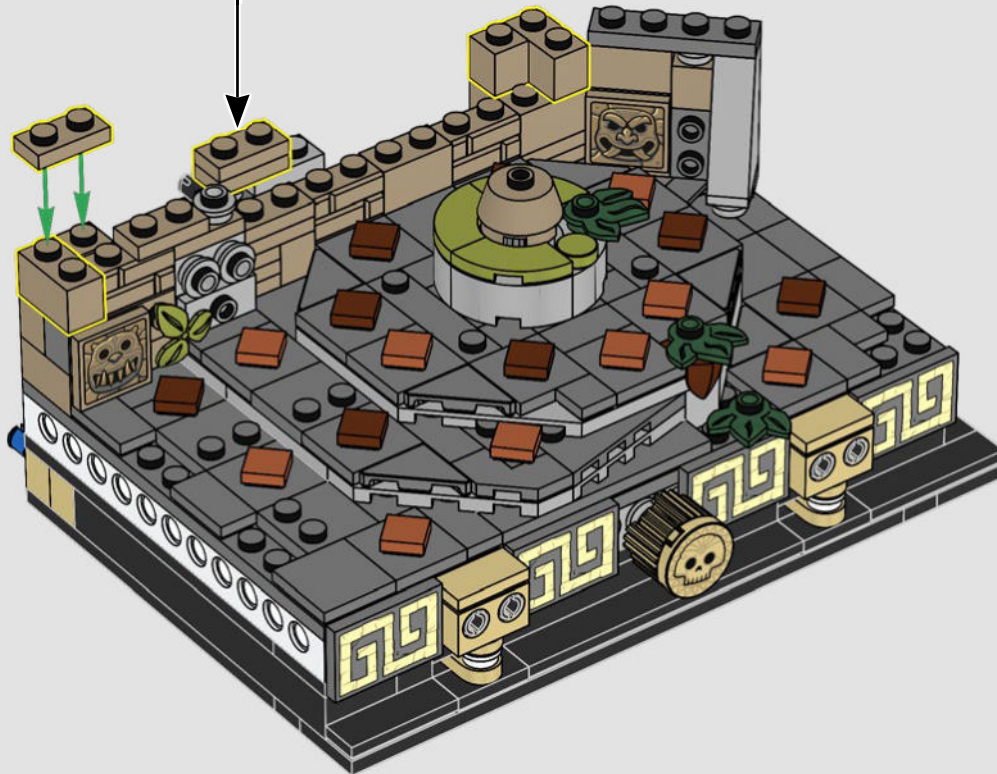
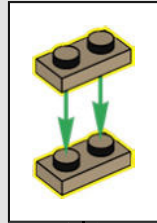

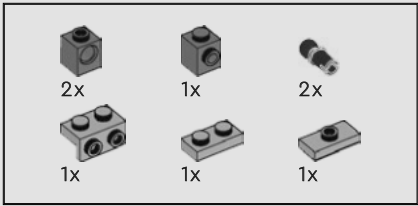

308

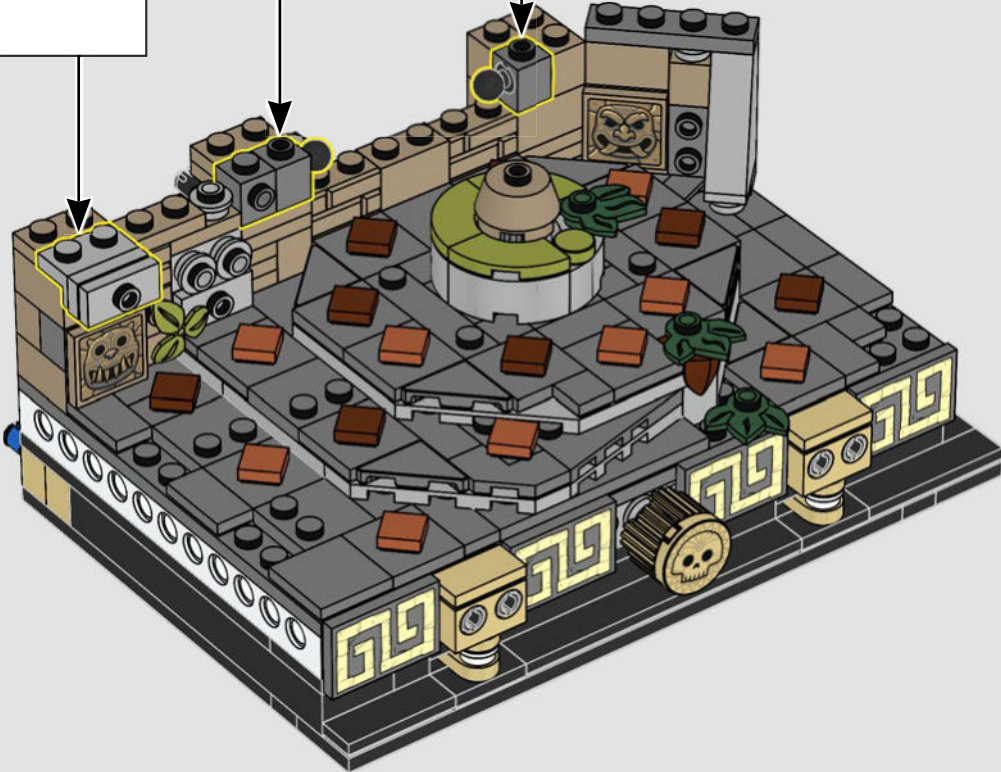
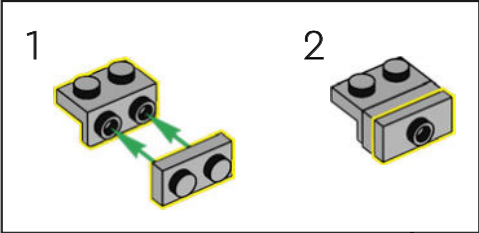
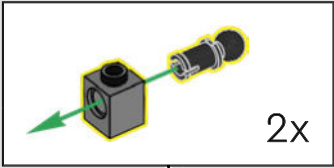

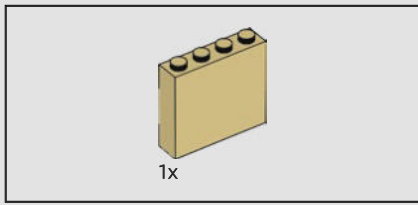

309

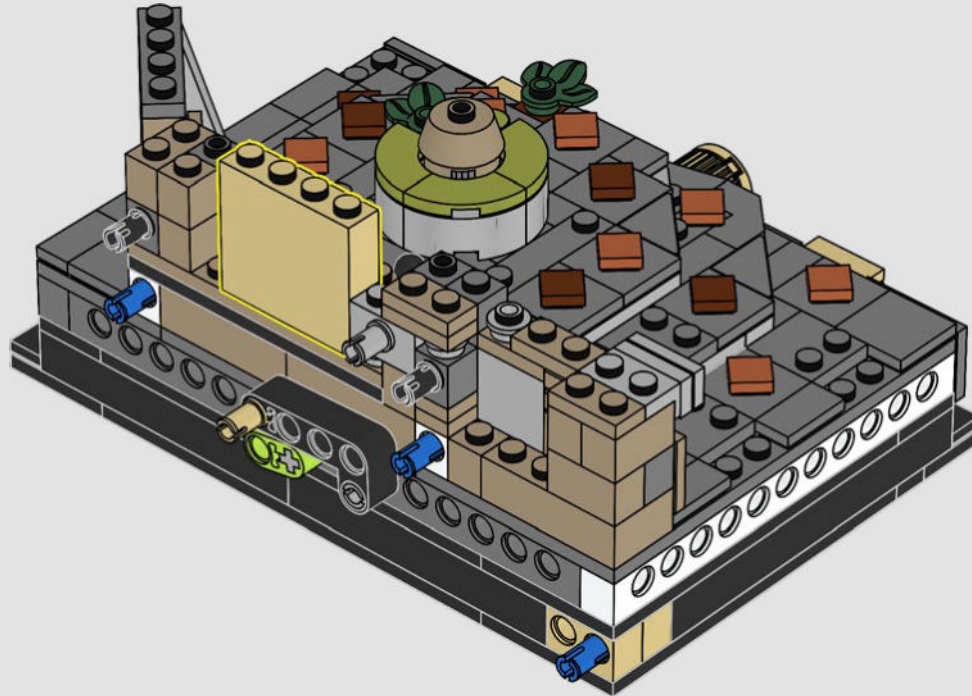

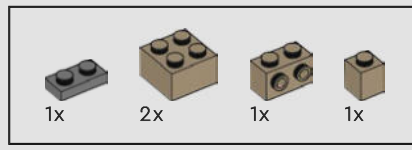

310



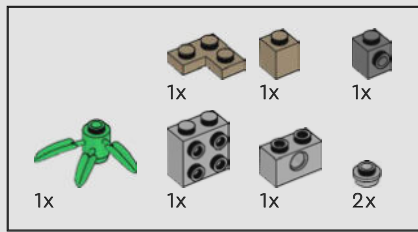

311

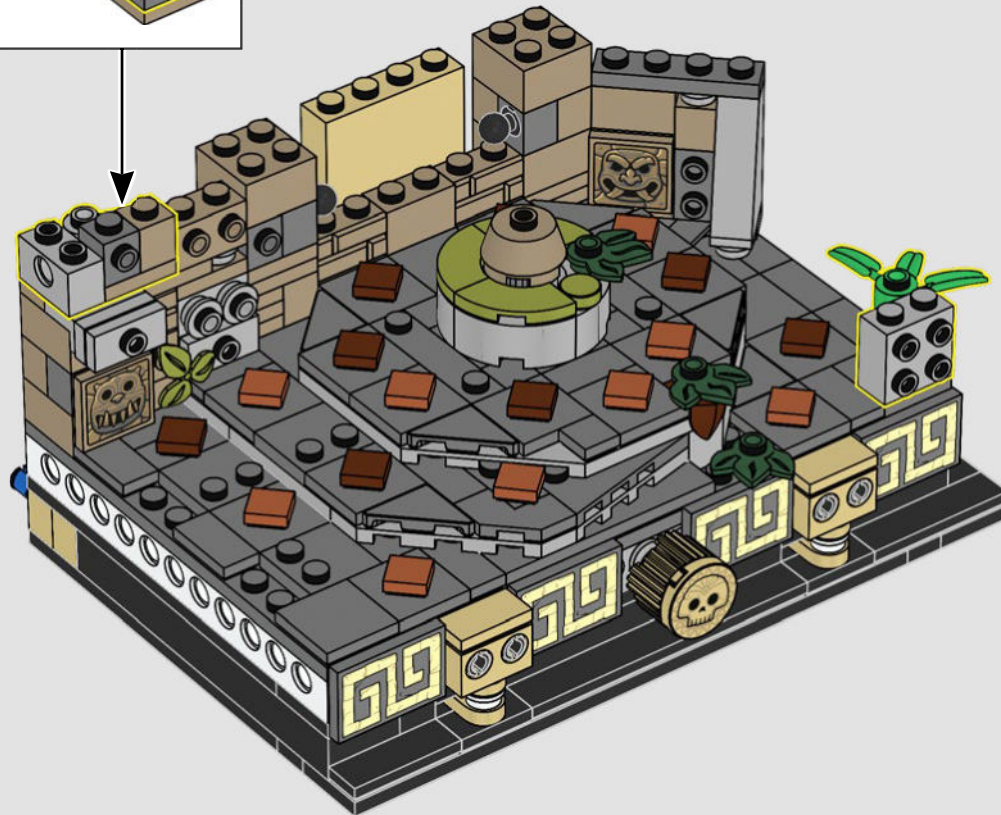
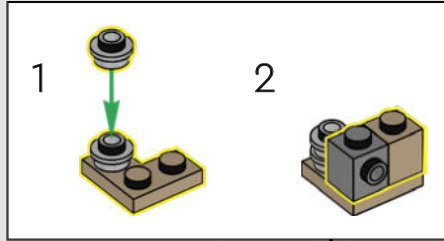

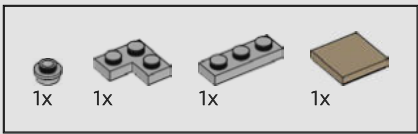

312

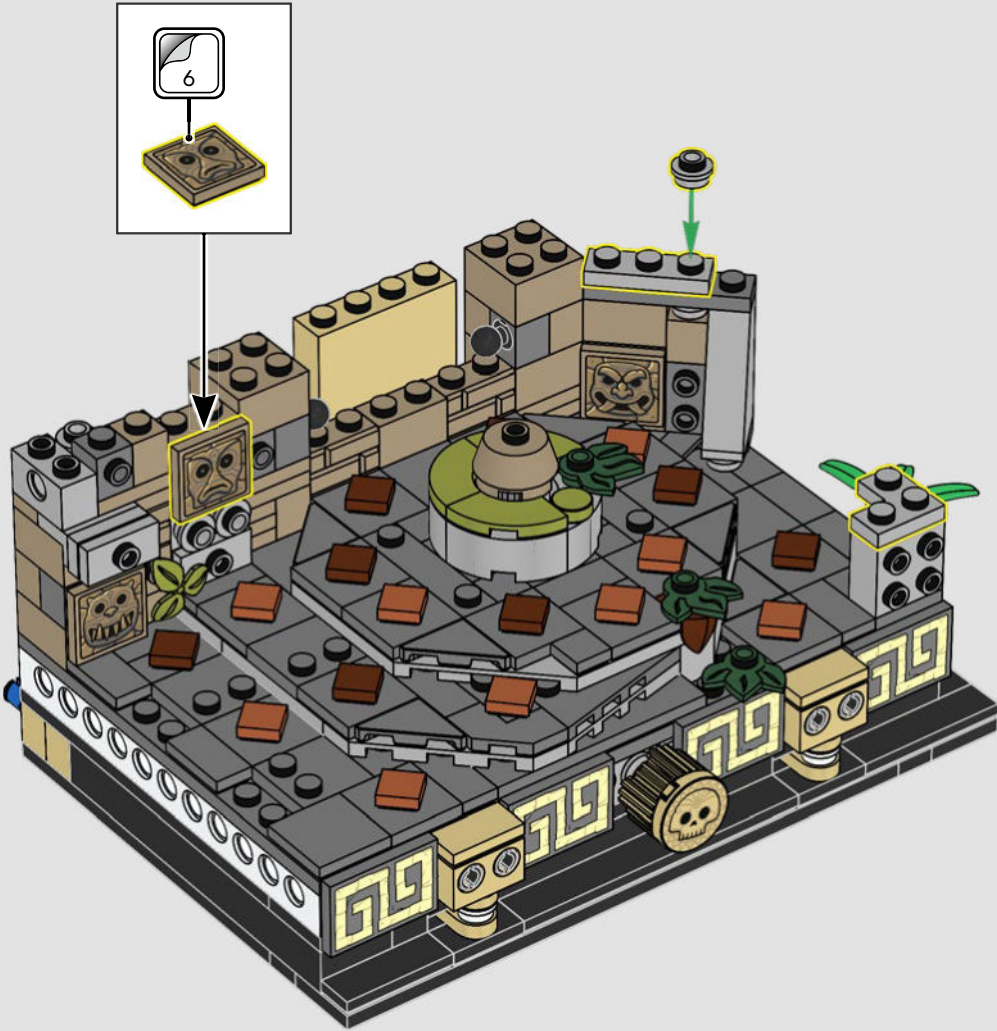

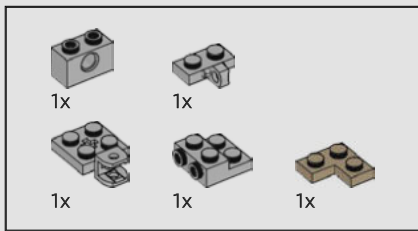

313

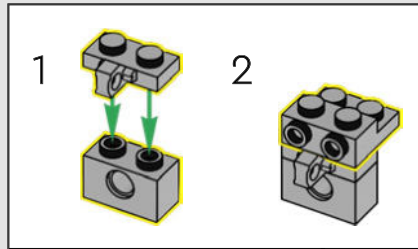

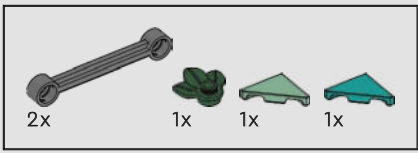

314

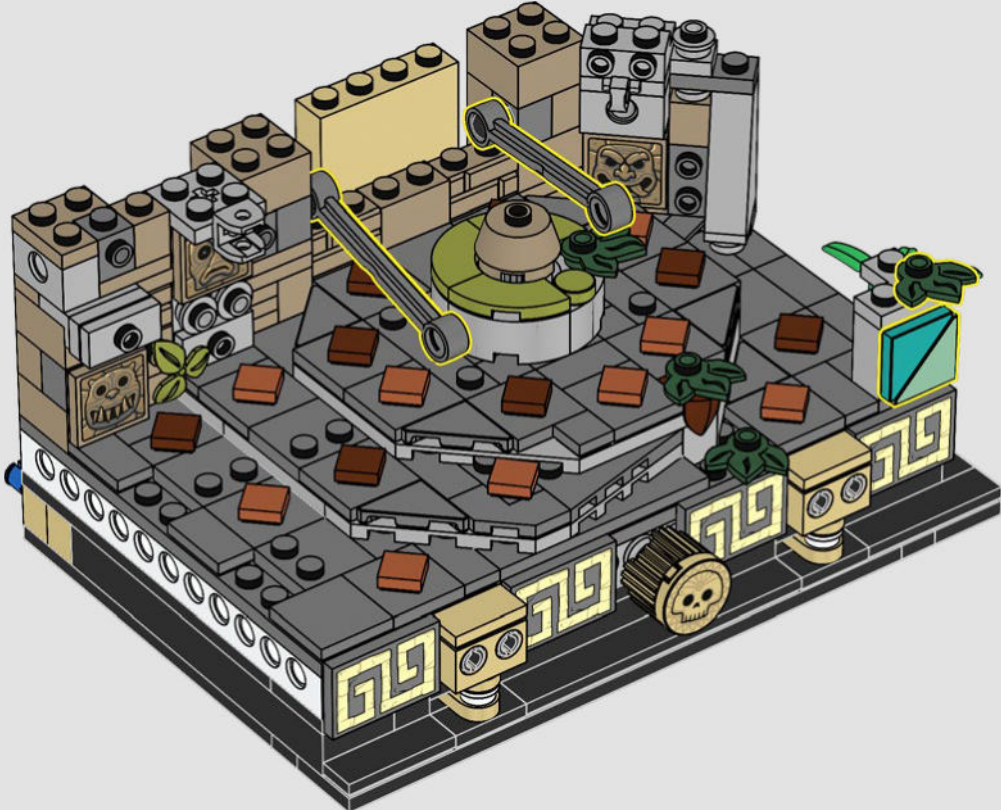

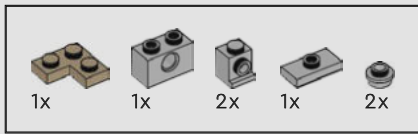

315

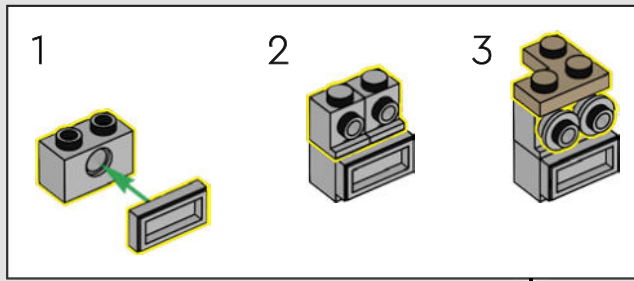

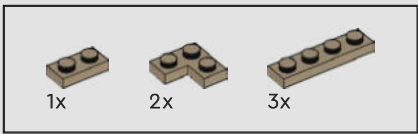

316



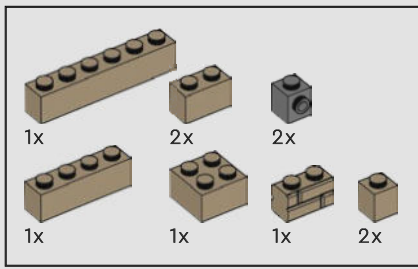

317

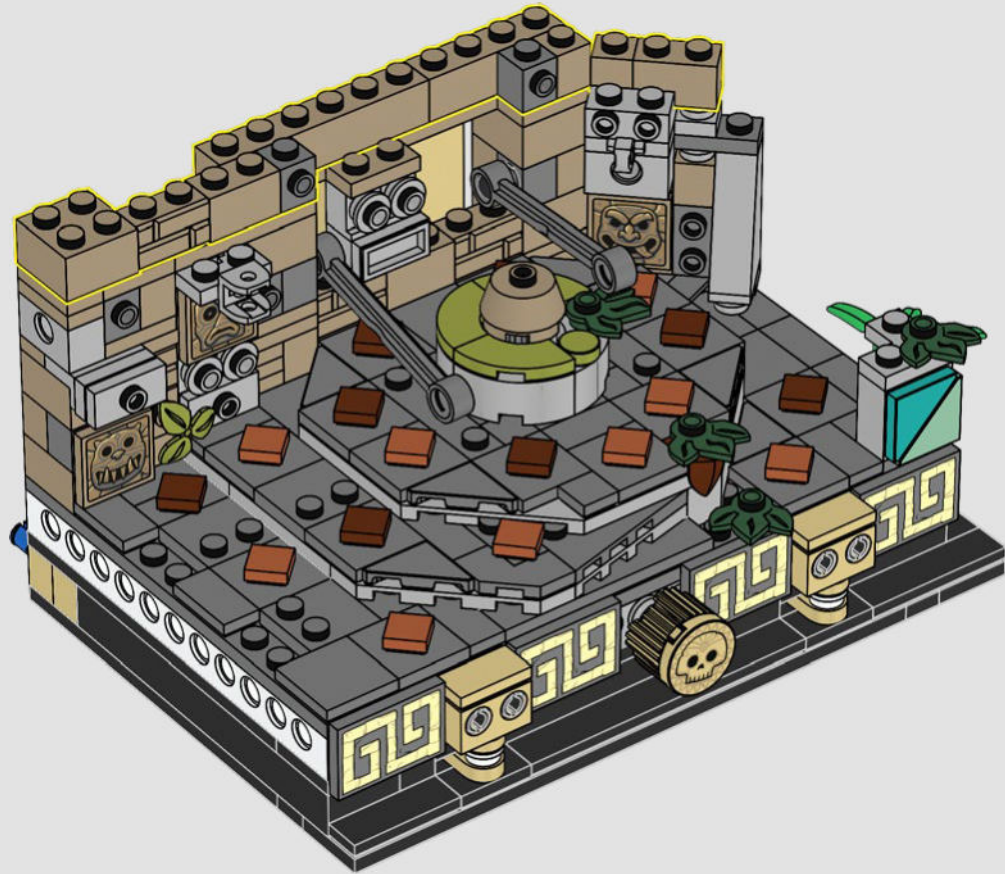



318



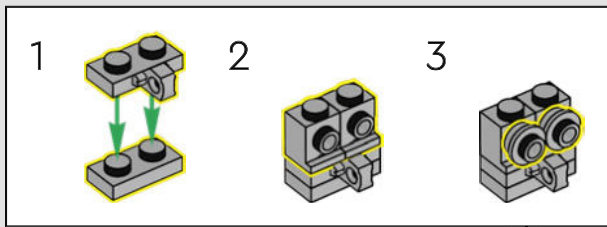
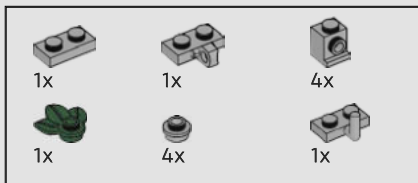

319

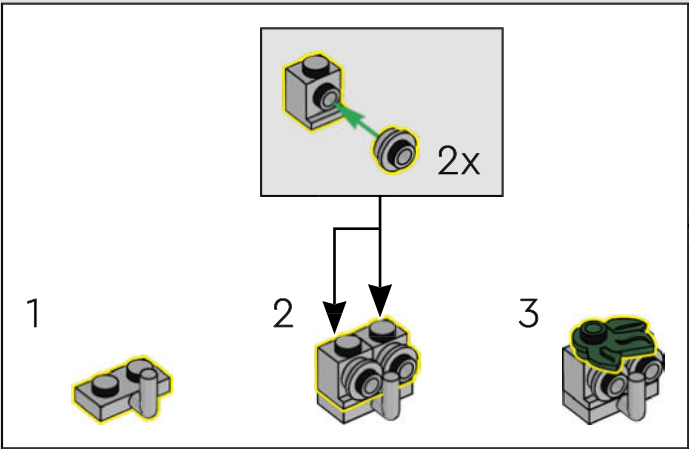

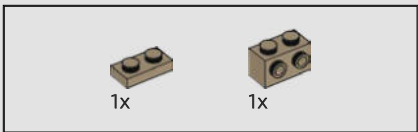

320

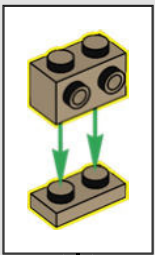

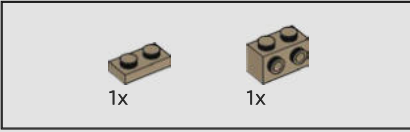
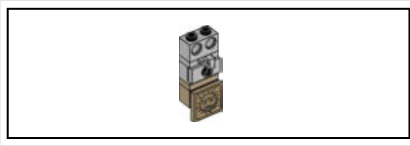

321

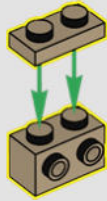

322

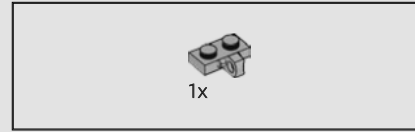
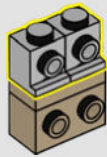

323

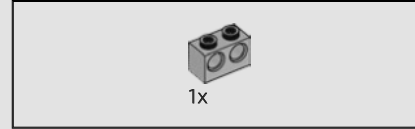
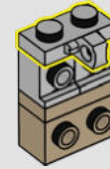

324

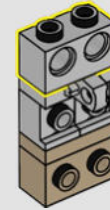

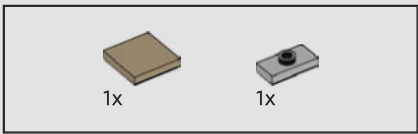

325

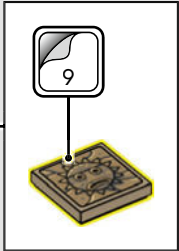
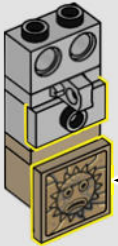

326

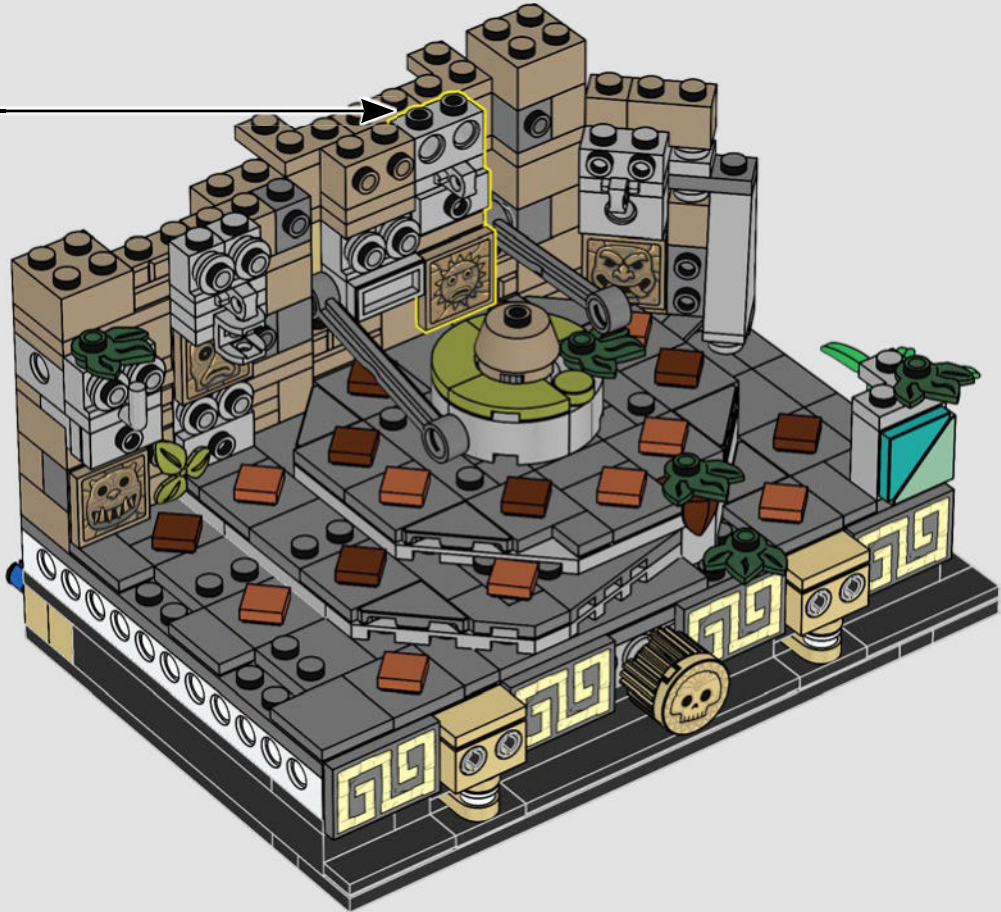

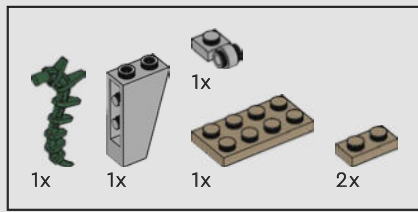

327

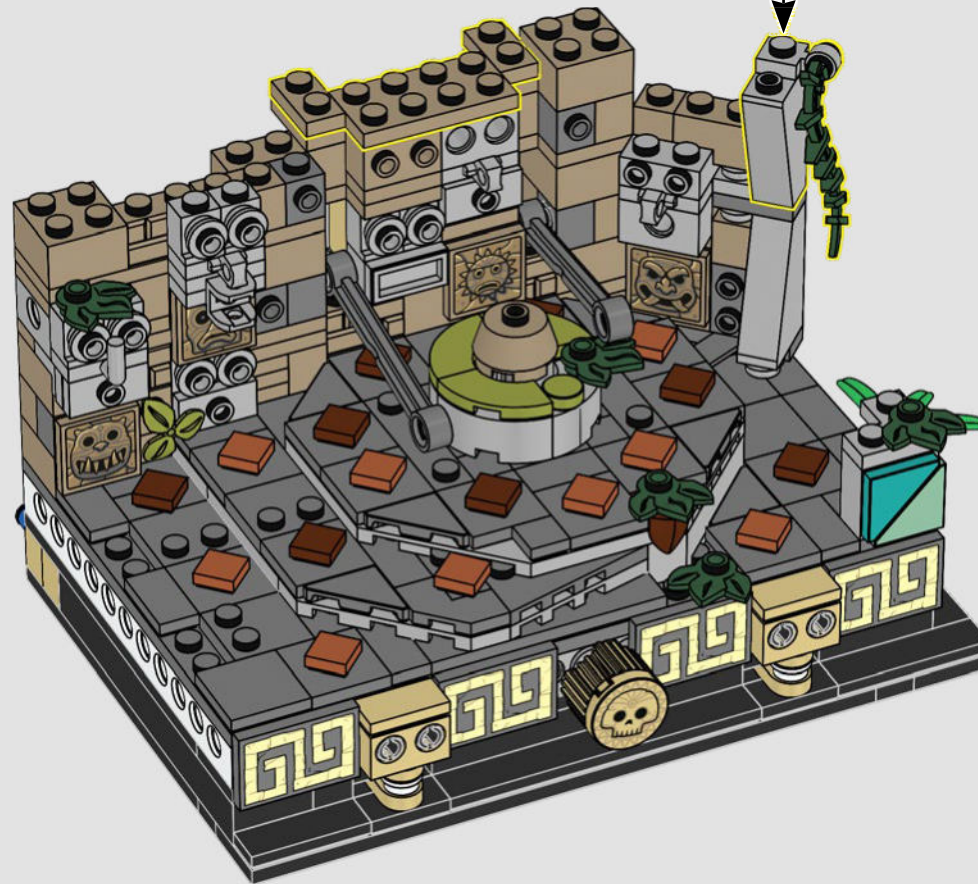
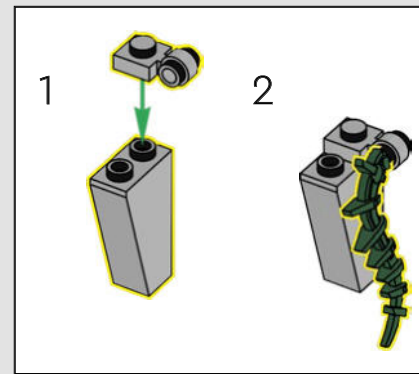

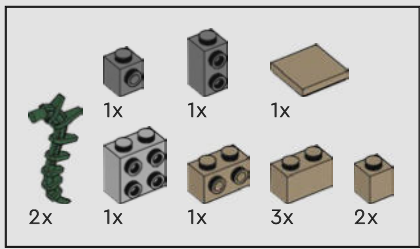

328

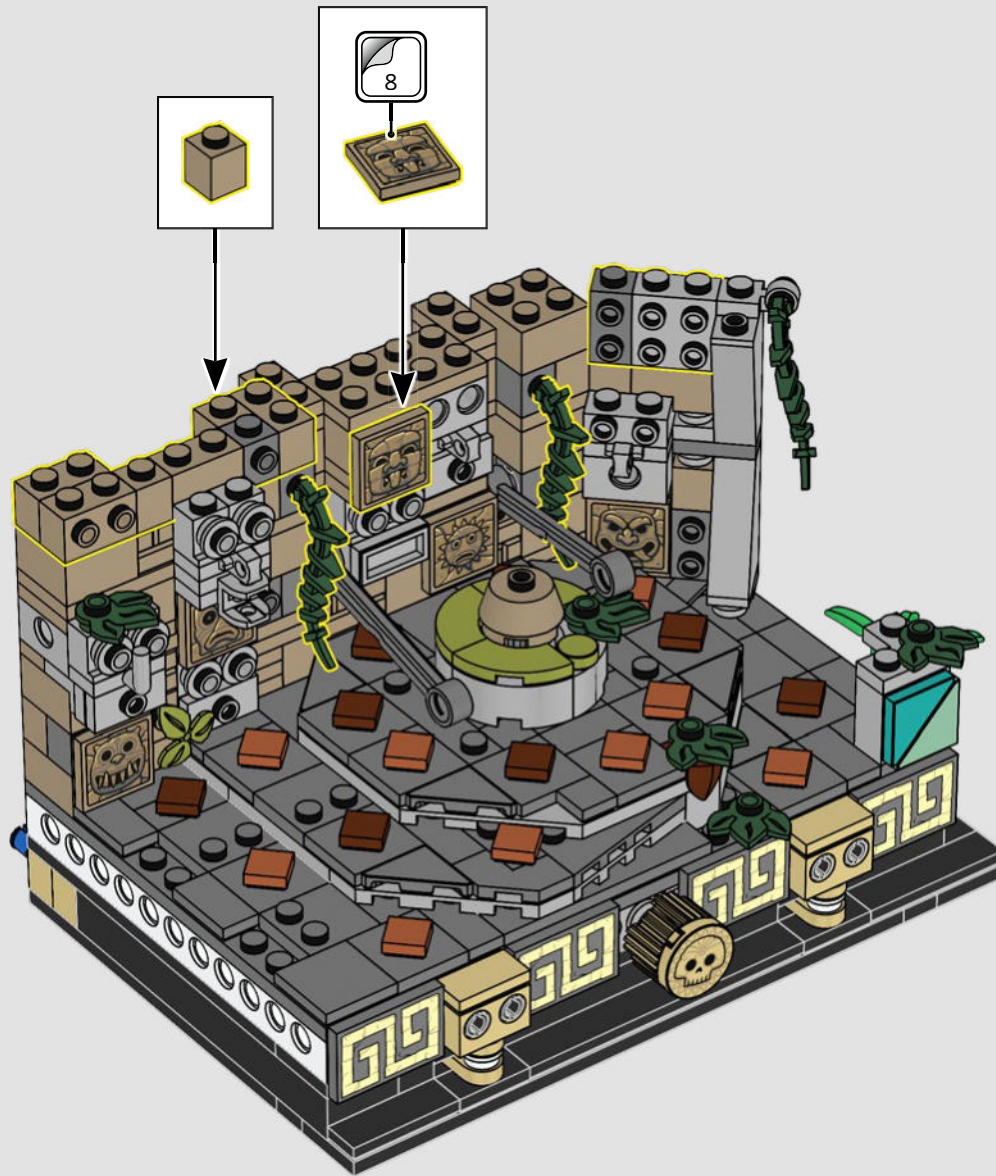

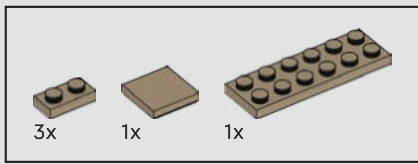

329

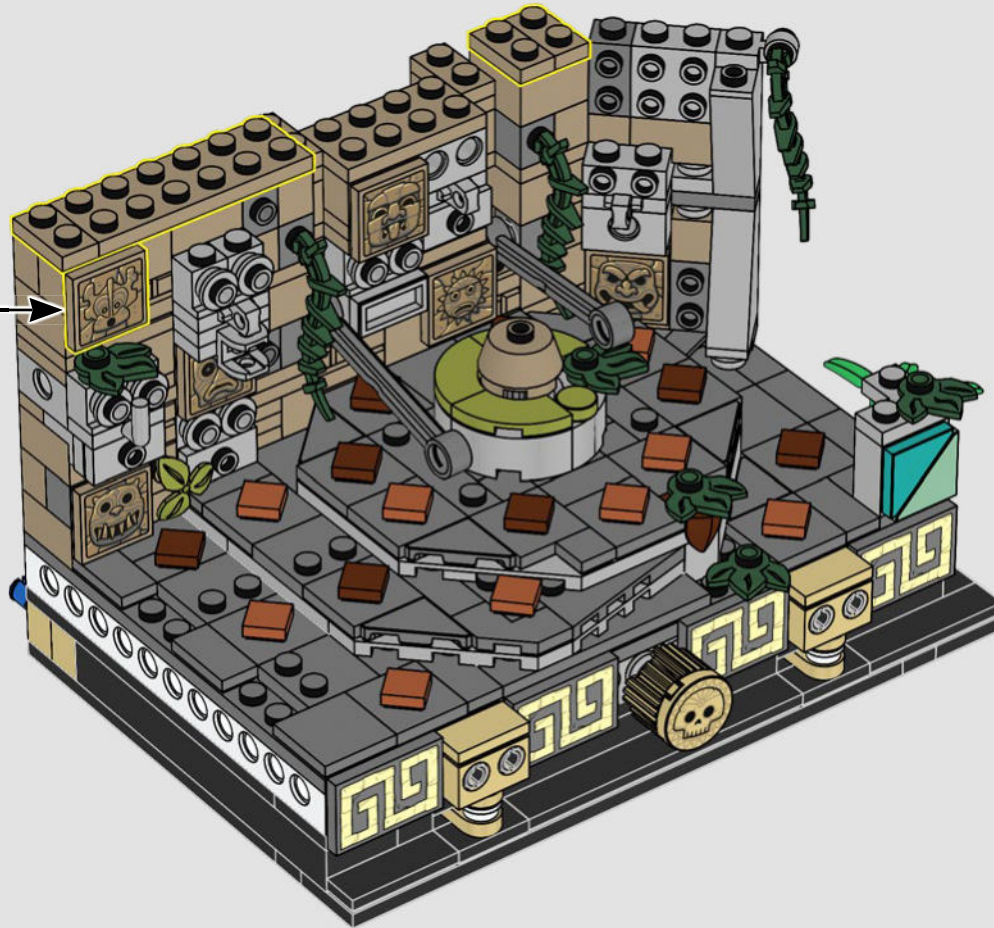
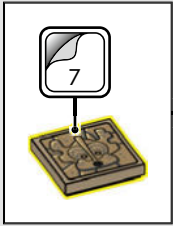

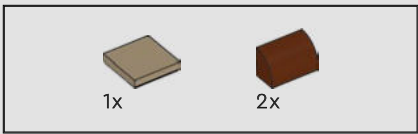

330

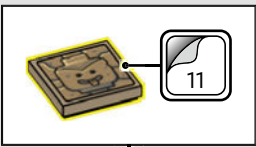

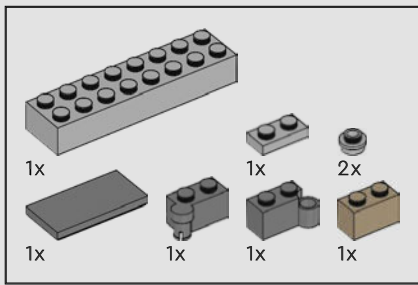

331

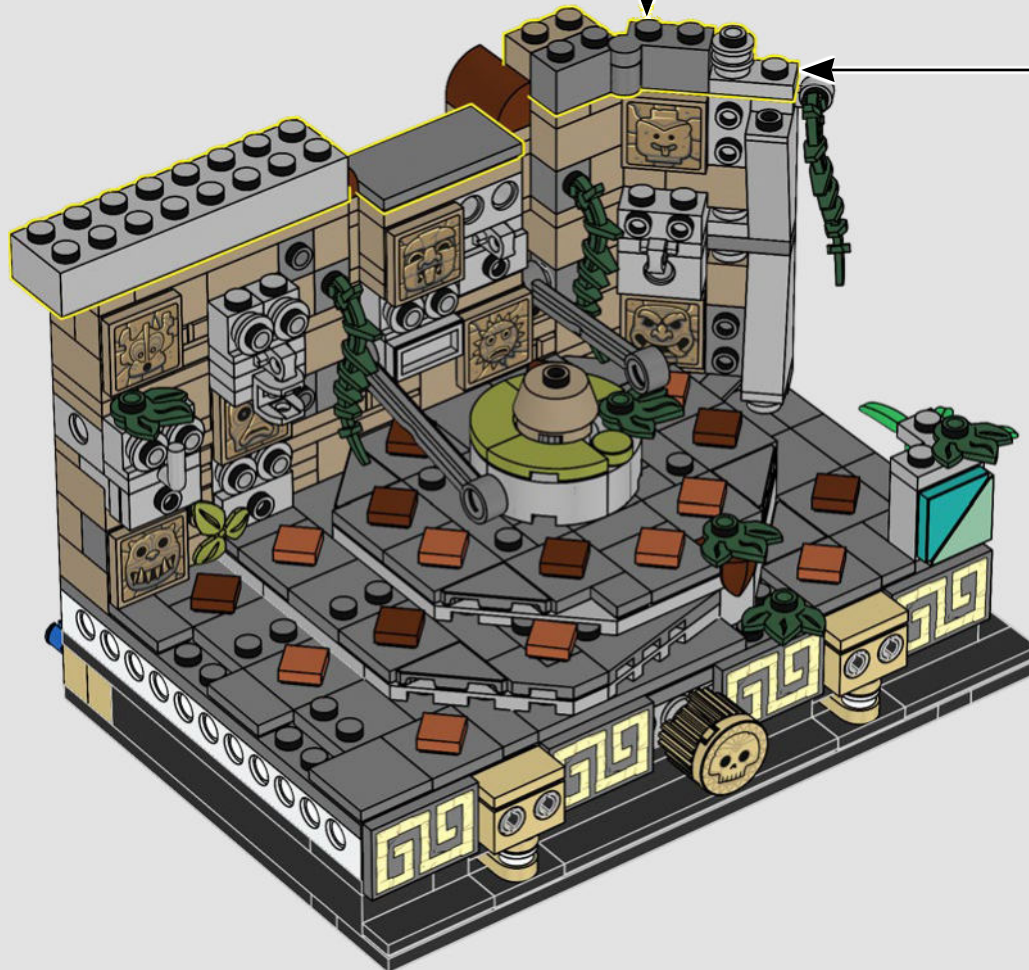
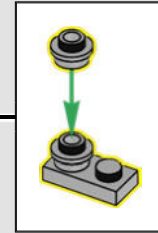
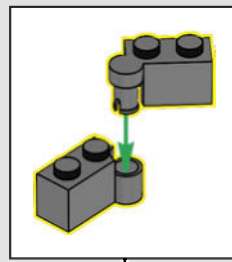

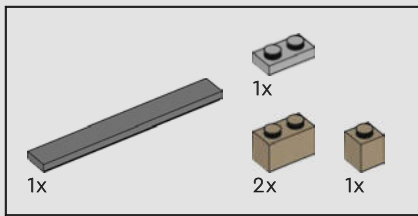

332

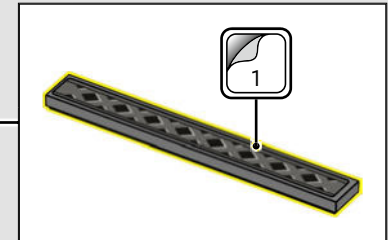
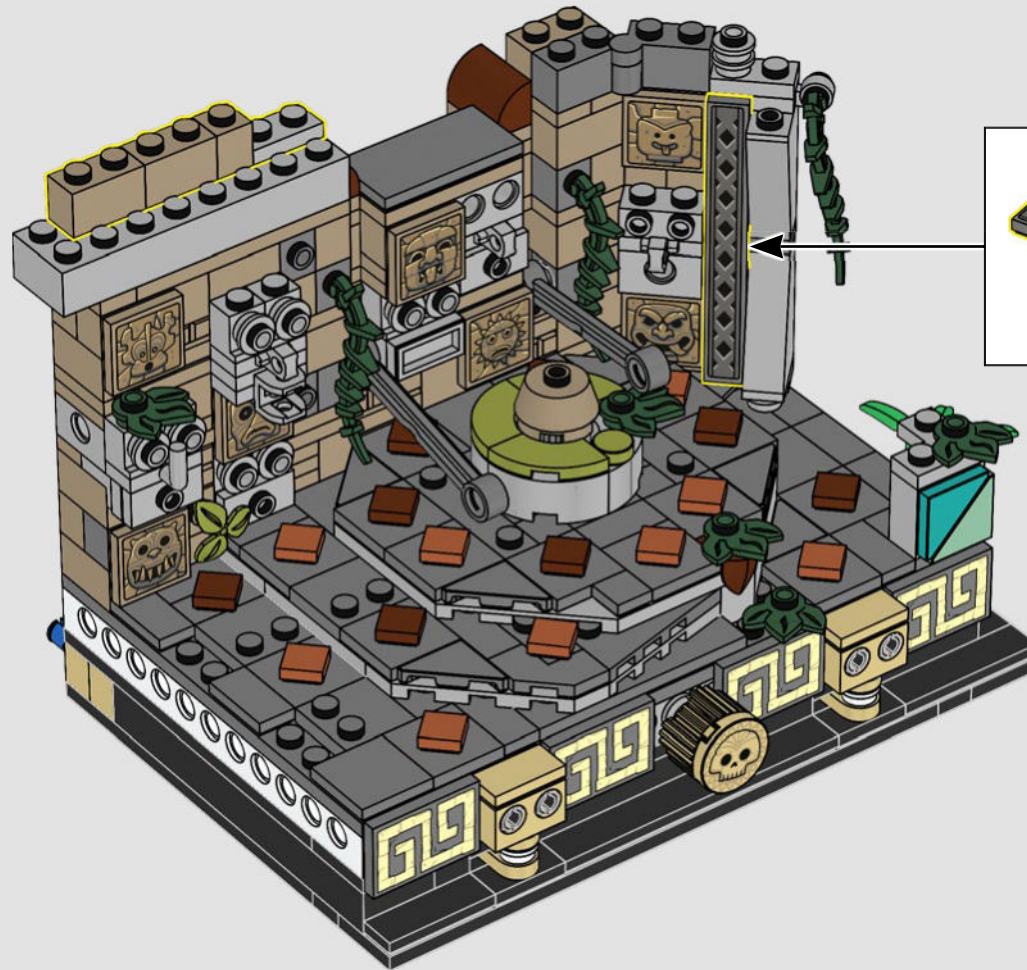

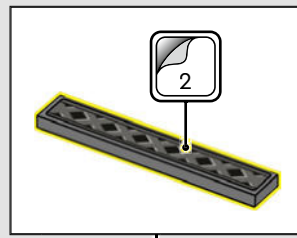
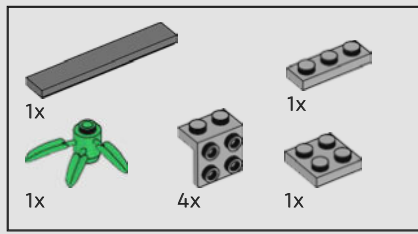

333



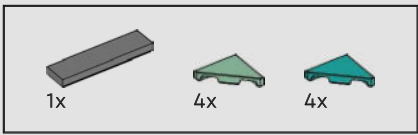

334



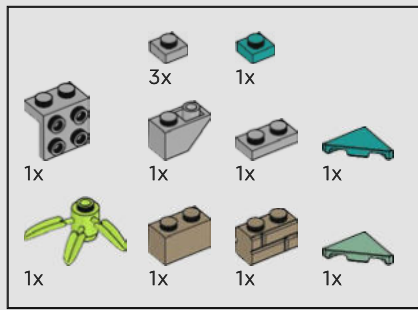

335

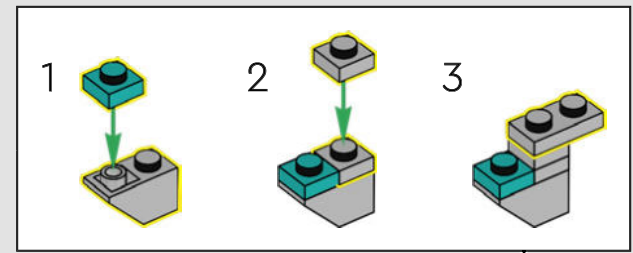
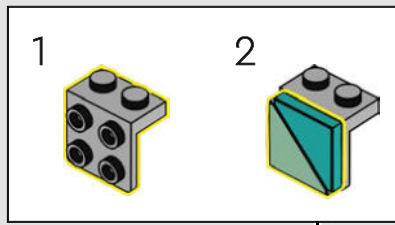

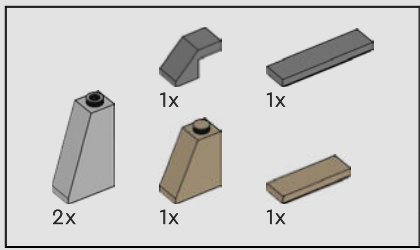

336



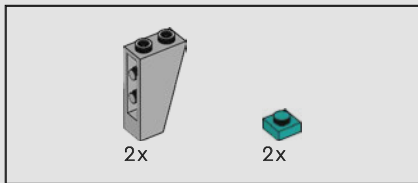

337

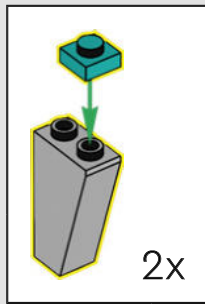



2x

338





339



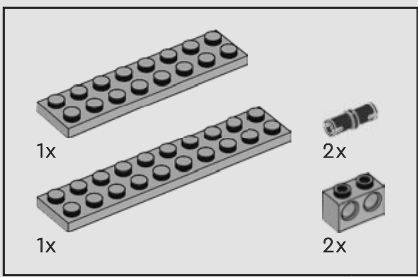

340

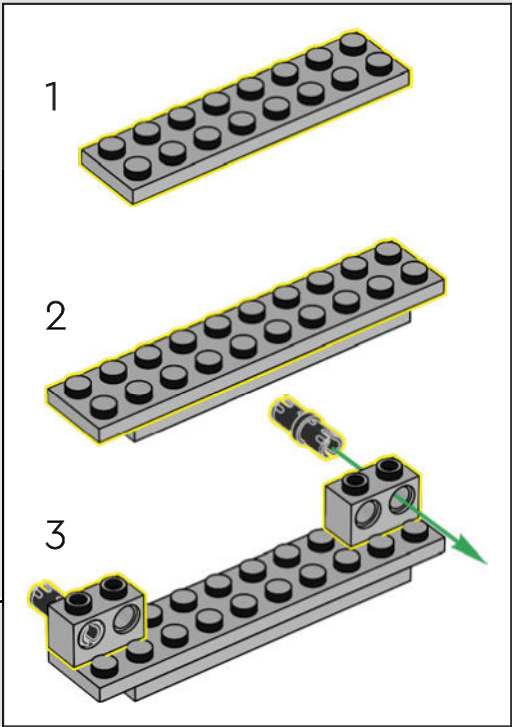

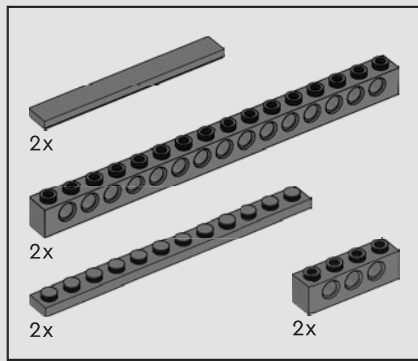

341

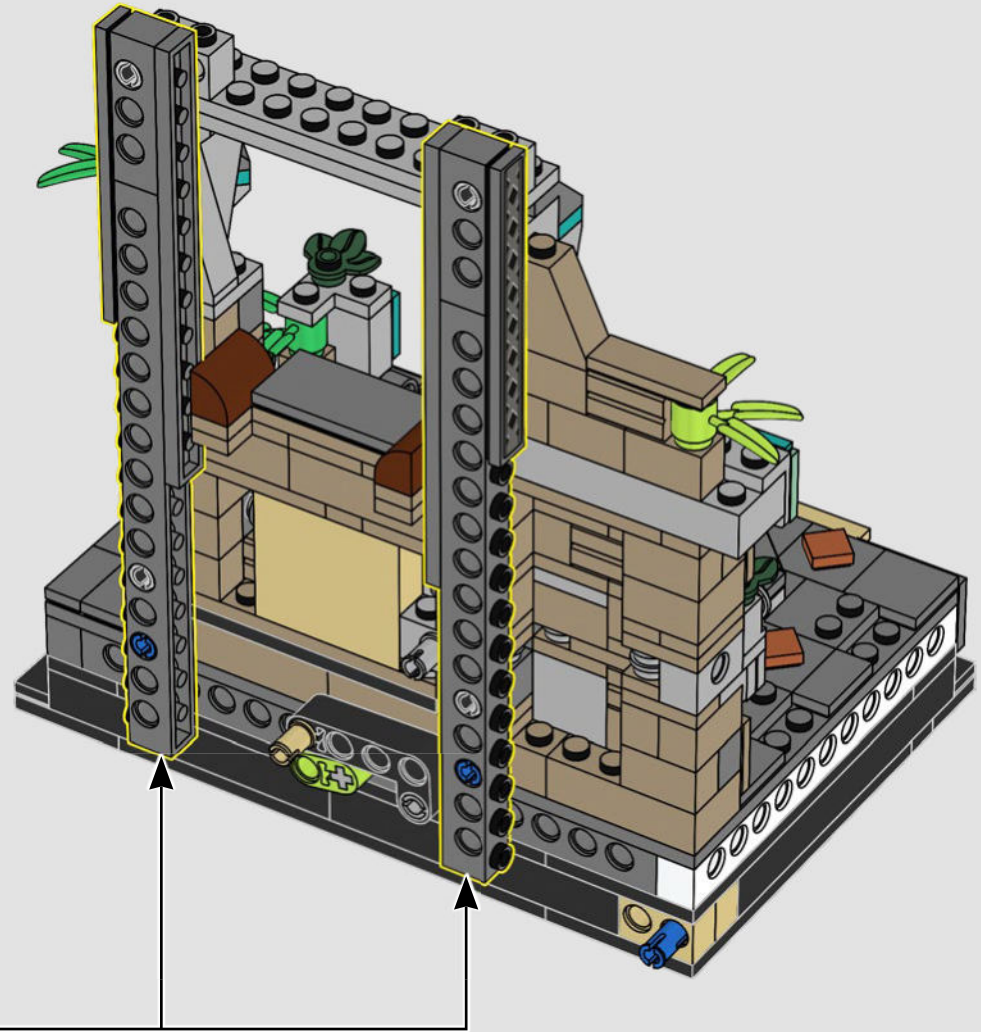
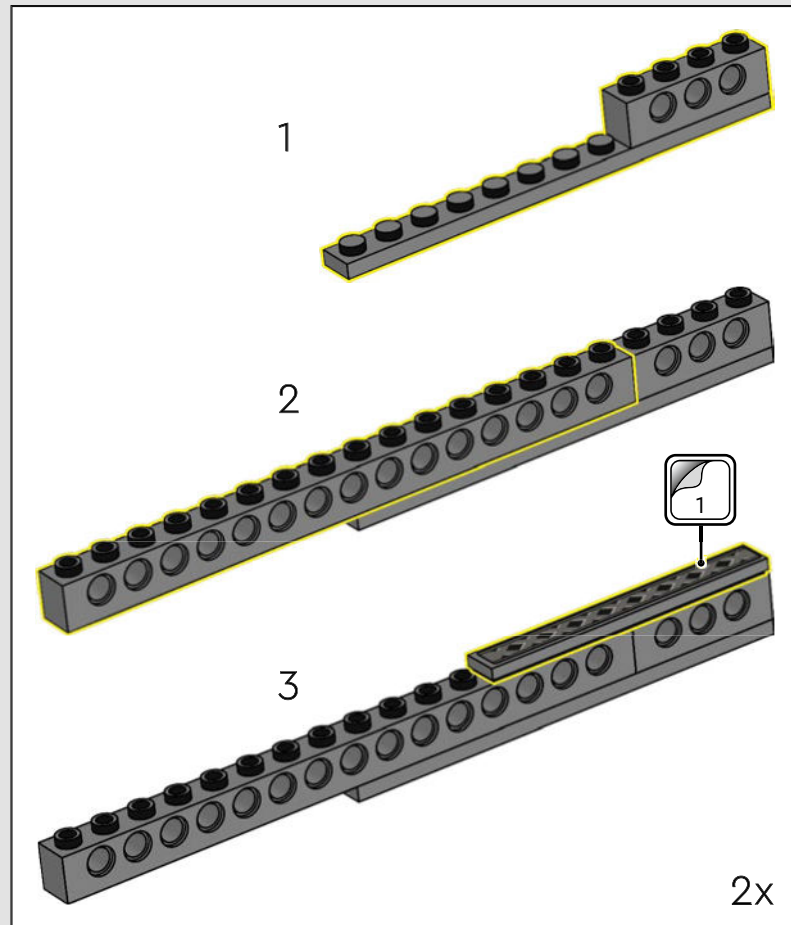

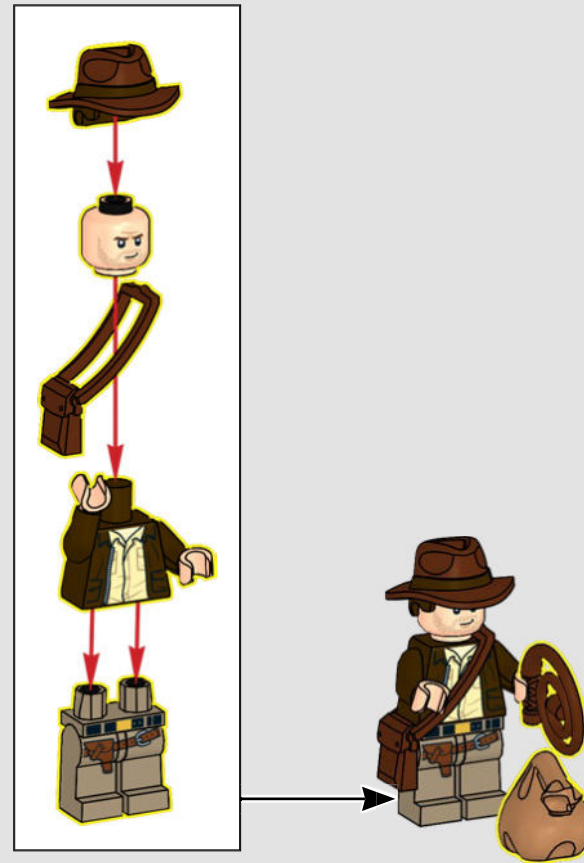

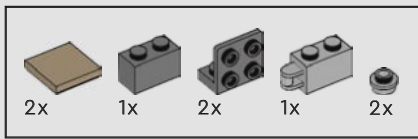

342

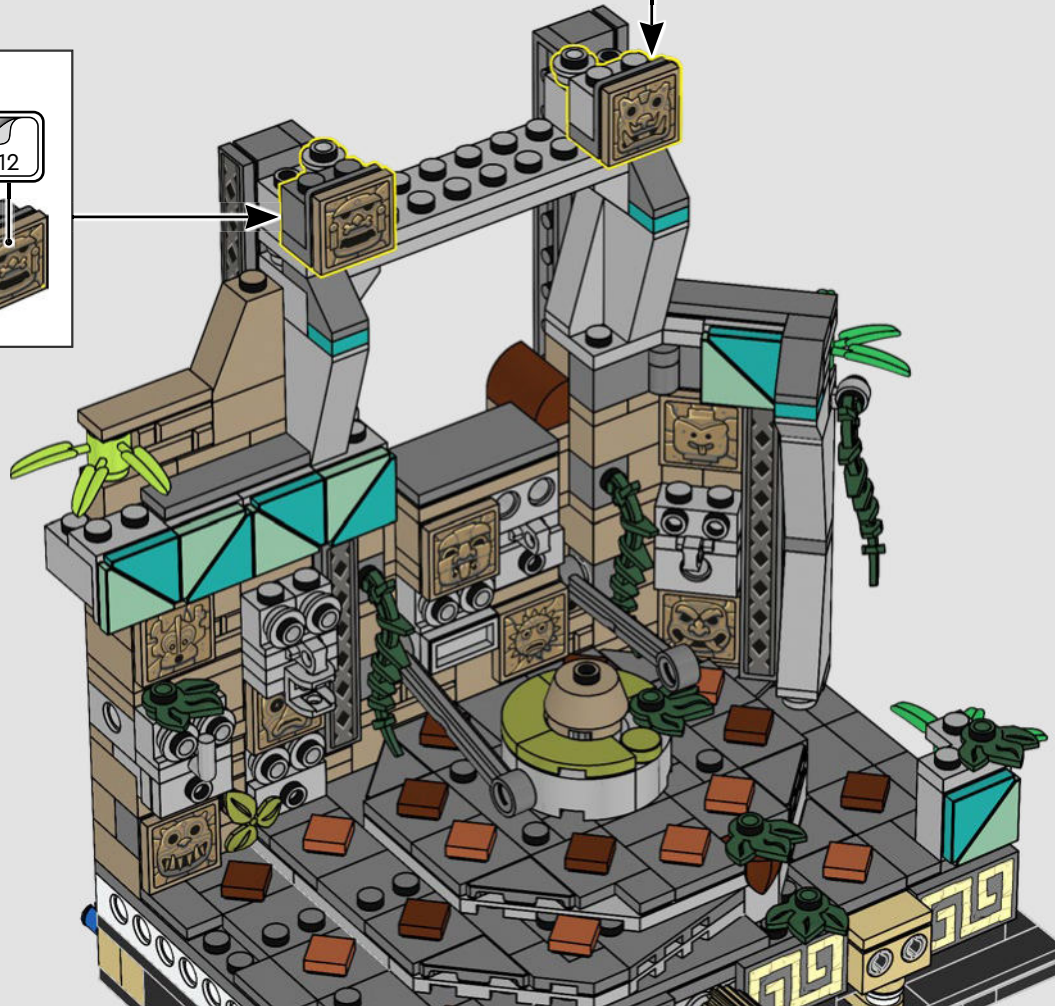
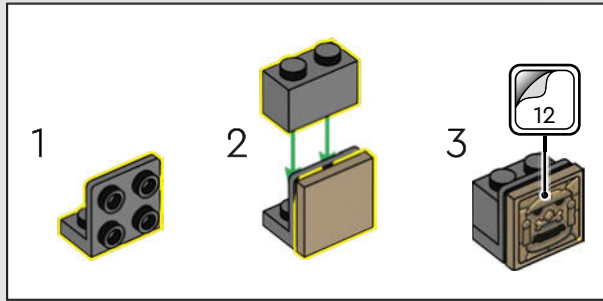
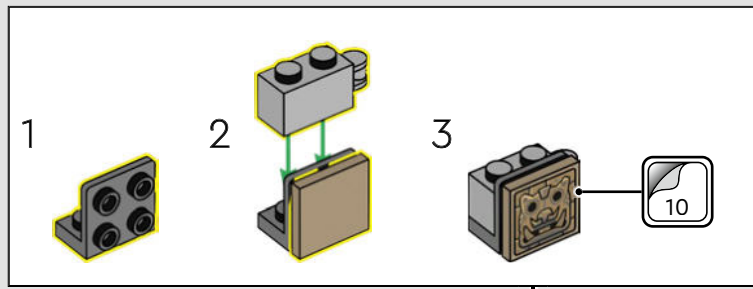

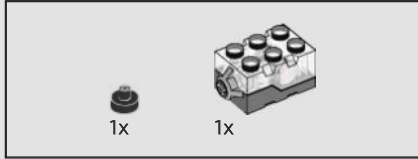
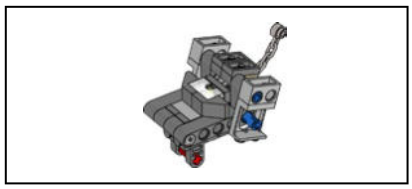

343

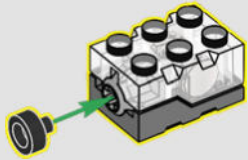

344

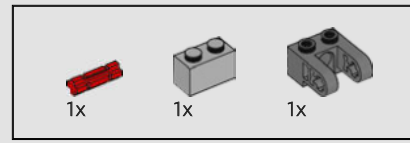
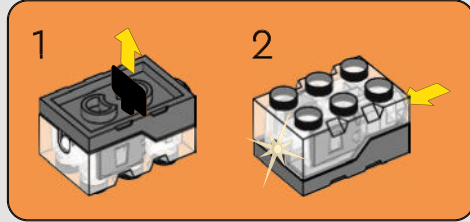
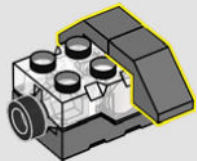

345

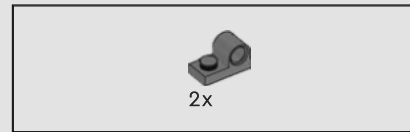
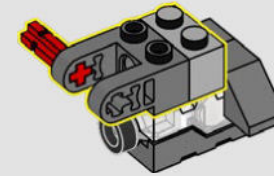

346

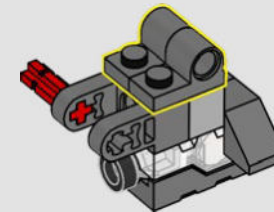



347

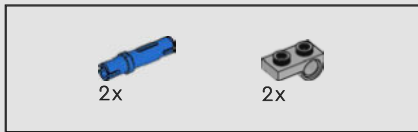
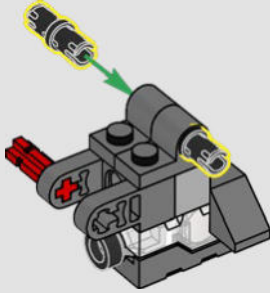

348

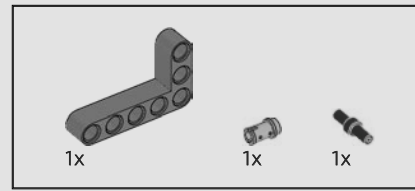
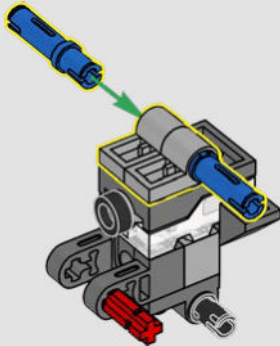

349

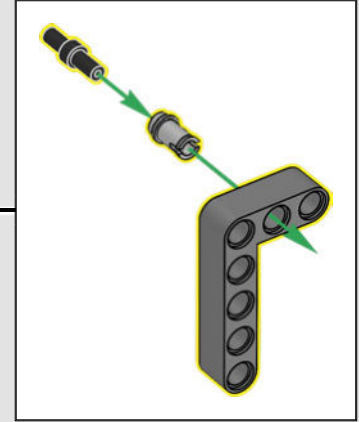
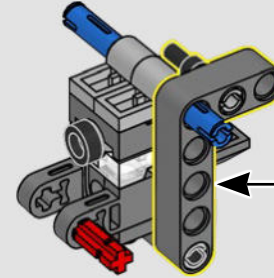

350

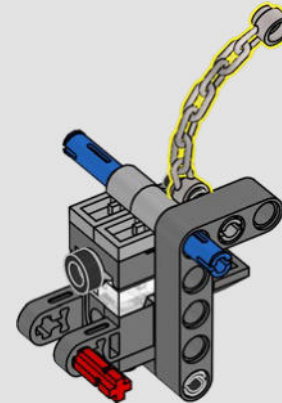

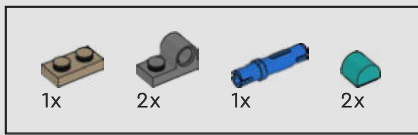

351

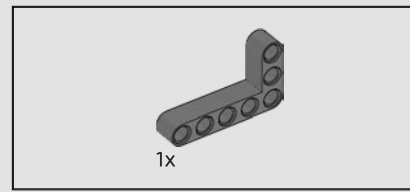
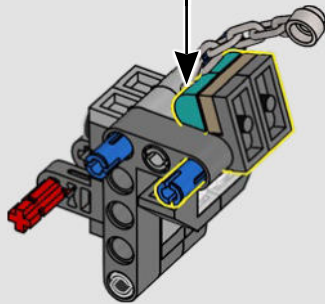
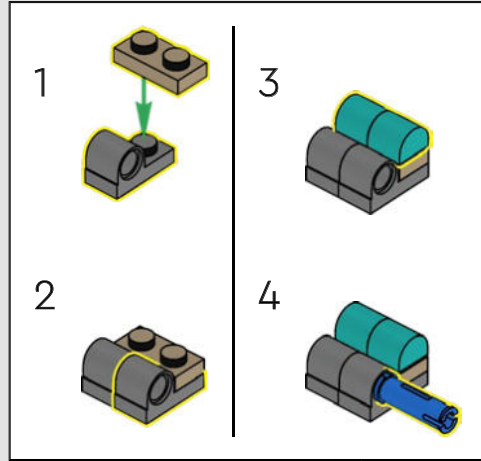

352

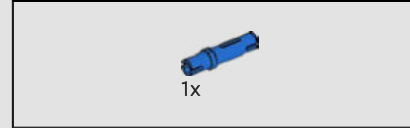
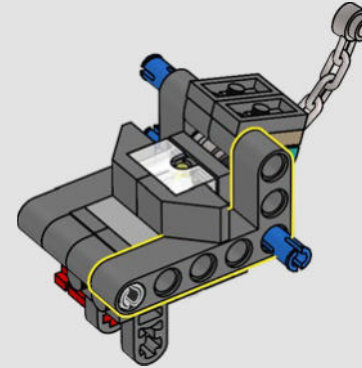

353

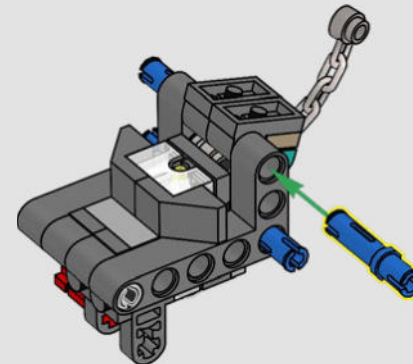

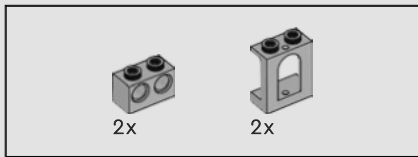

354

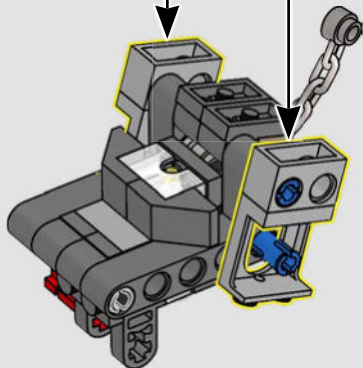
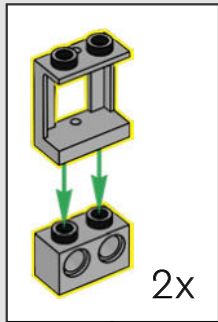

355

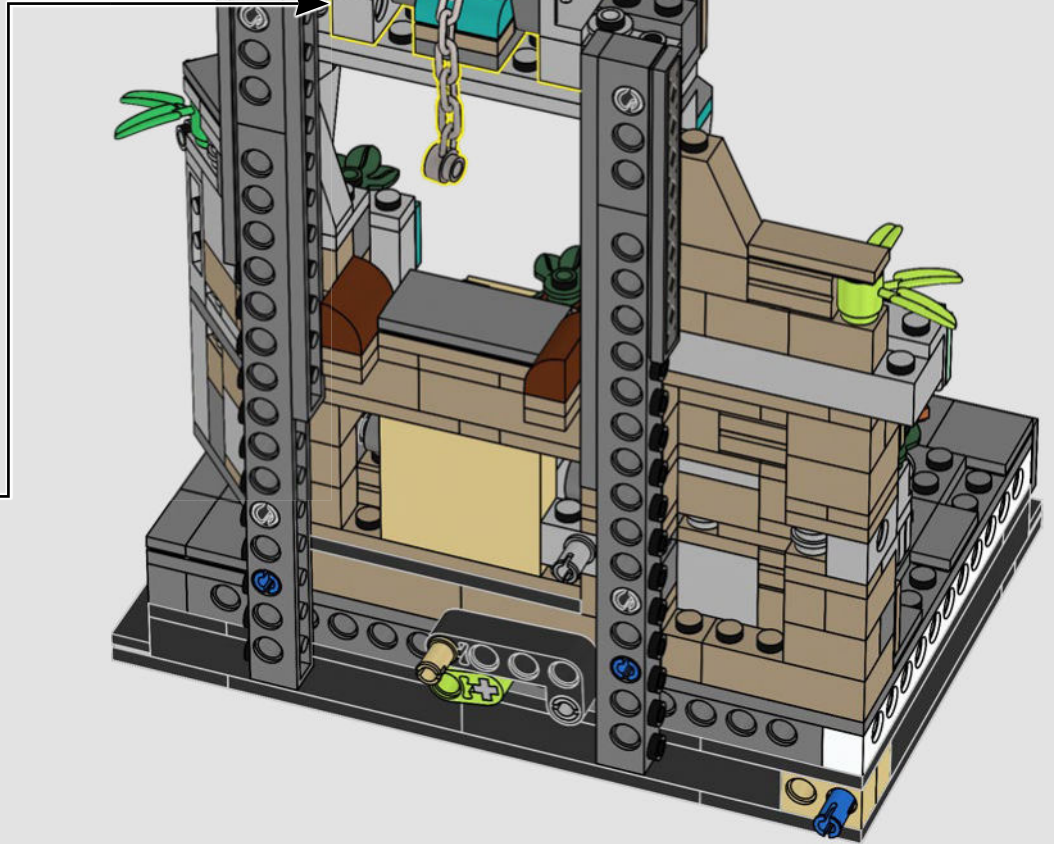
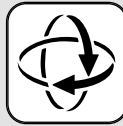



2x

356

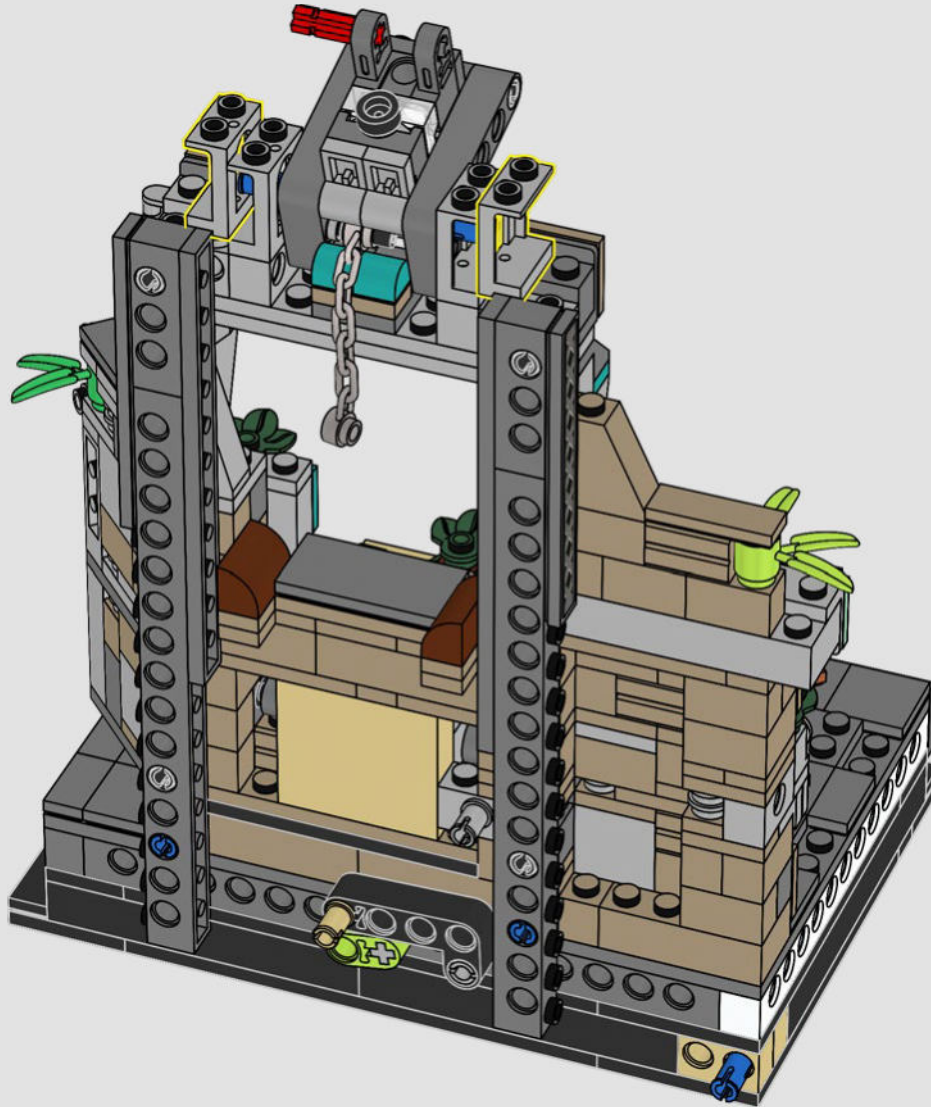



357

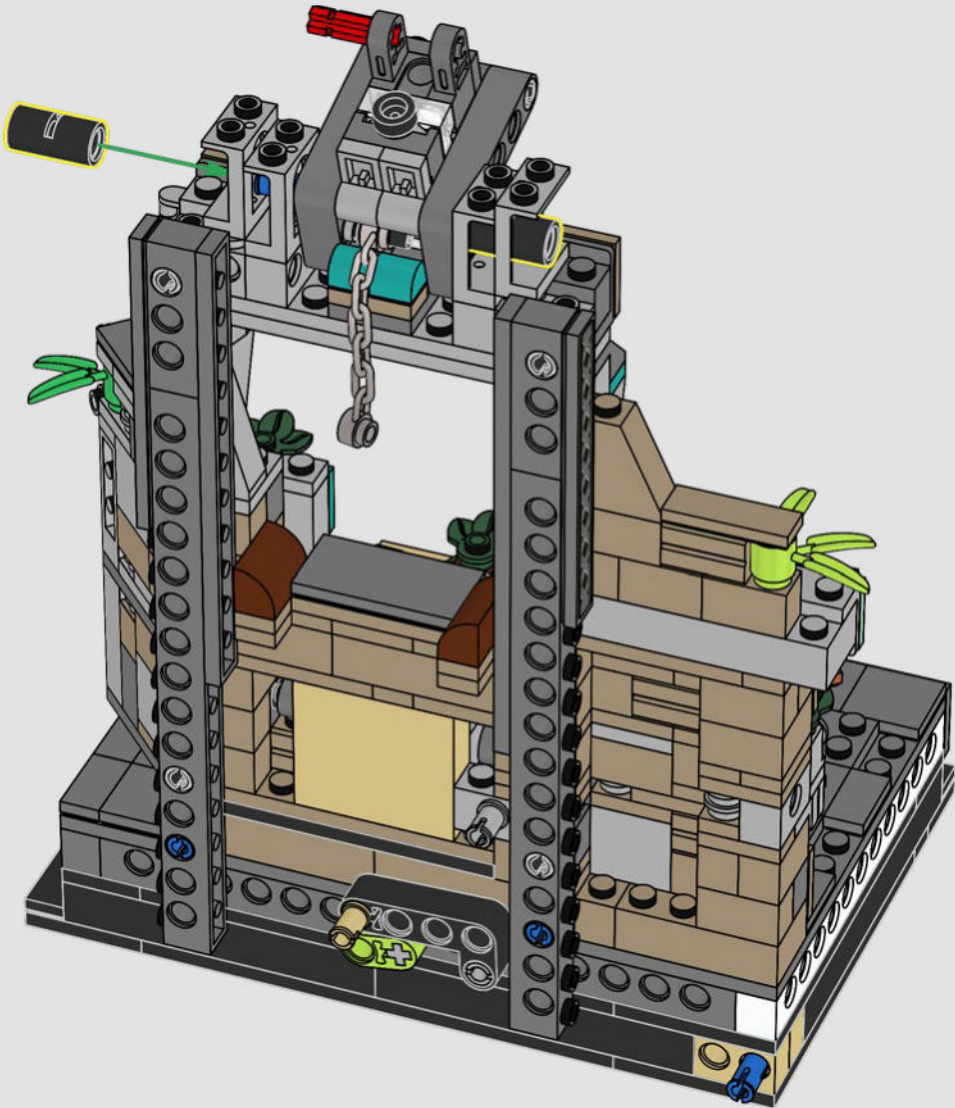

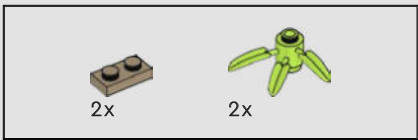

358

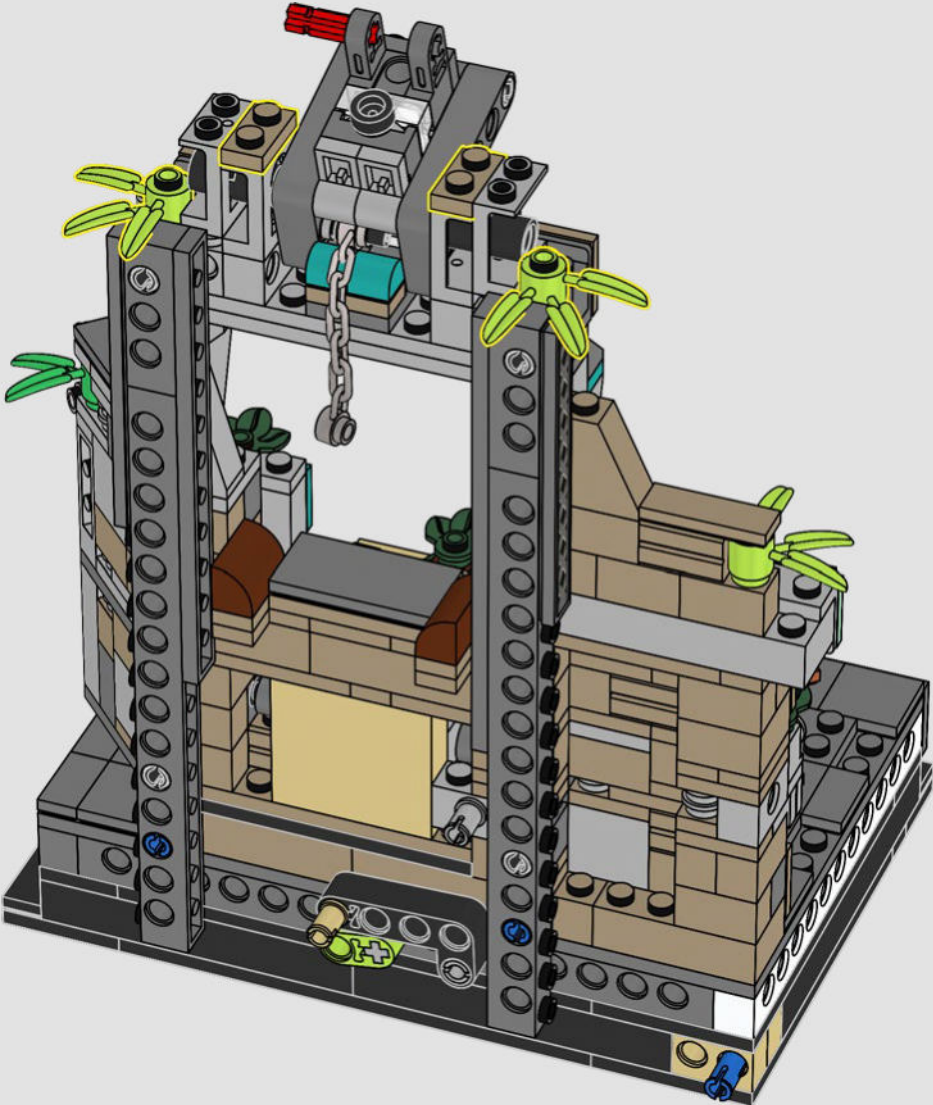

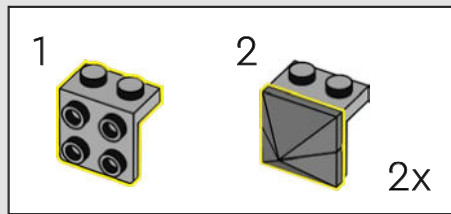
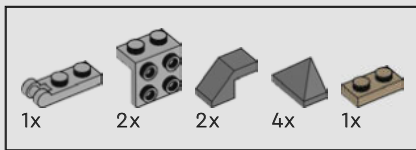

359

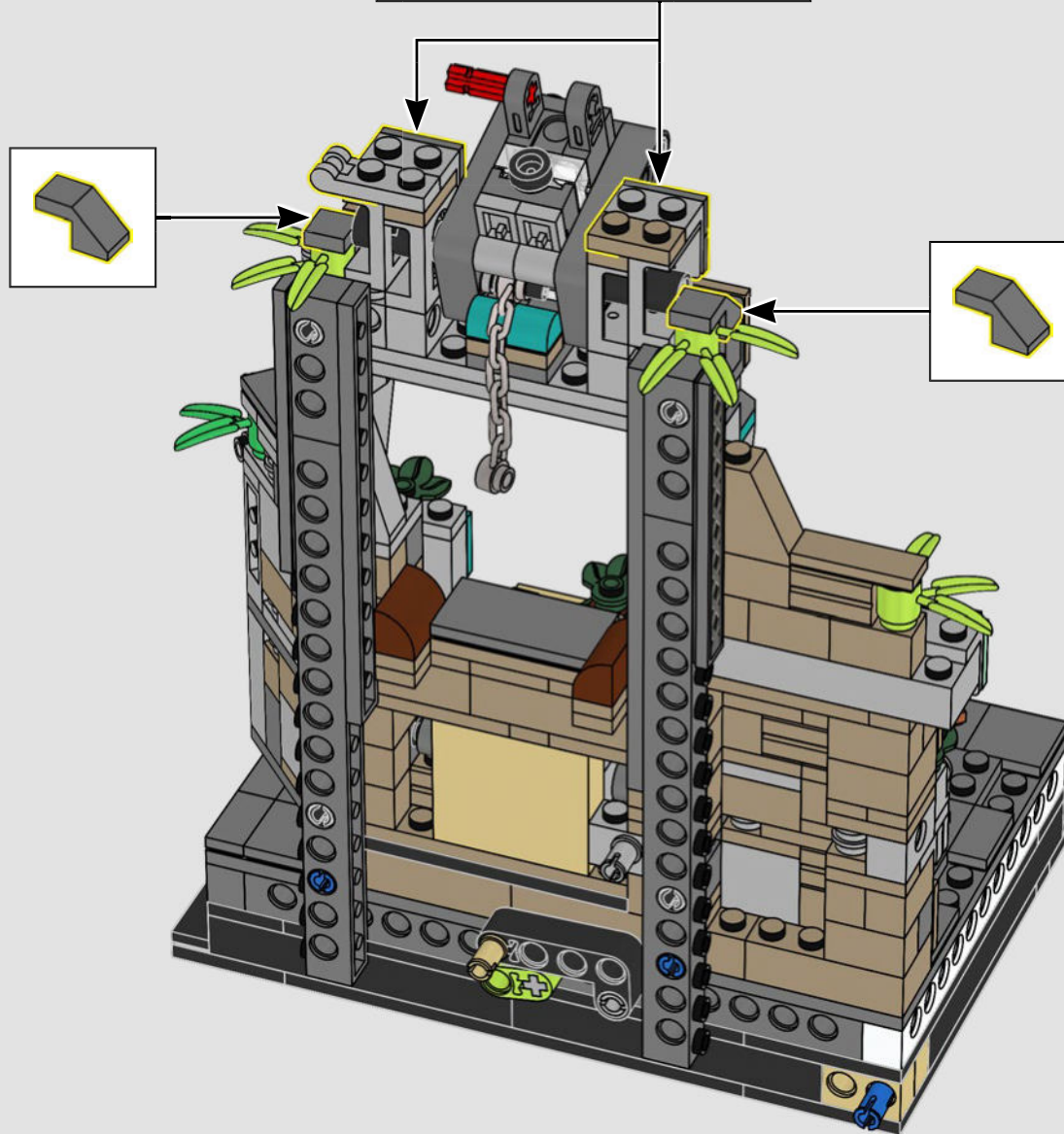

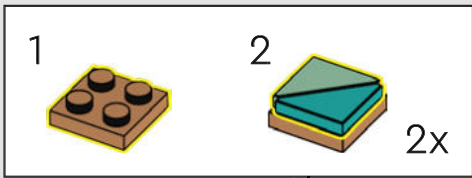

360

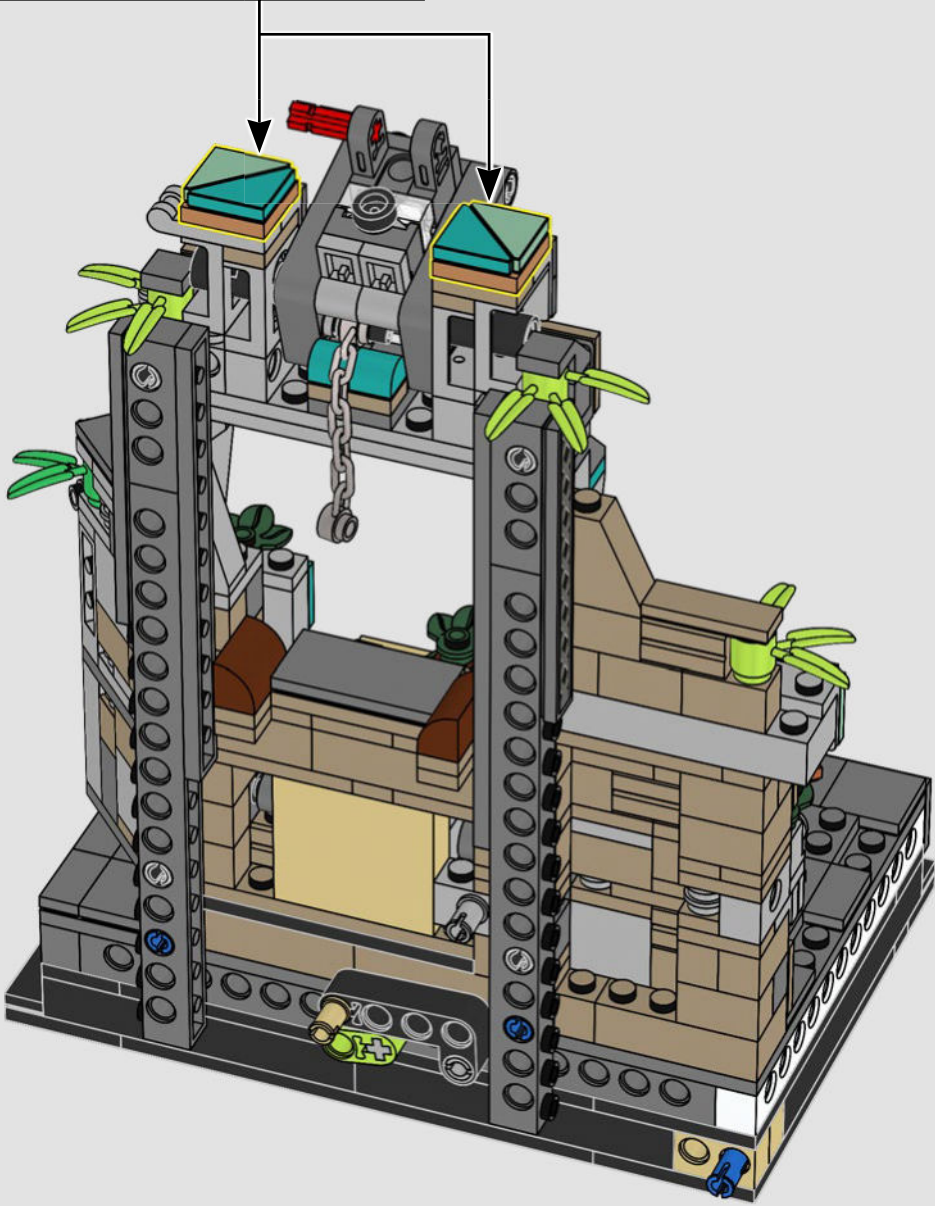

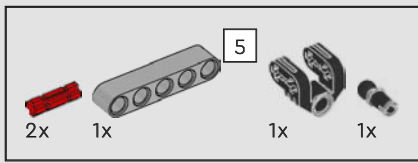

361

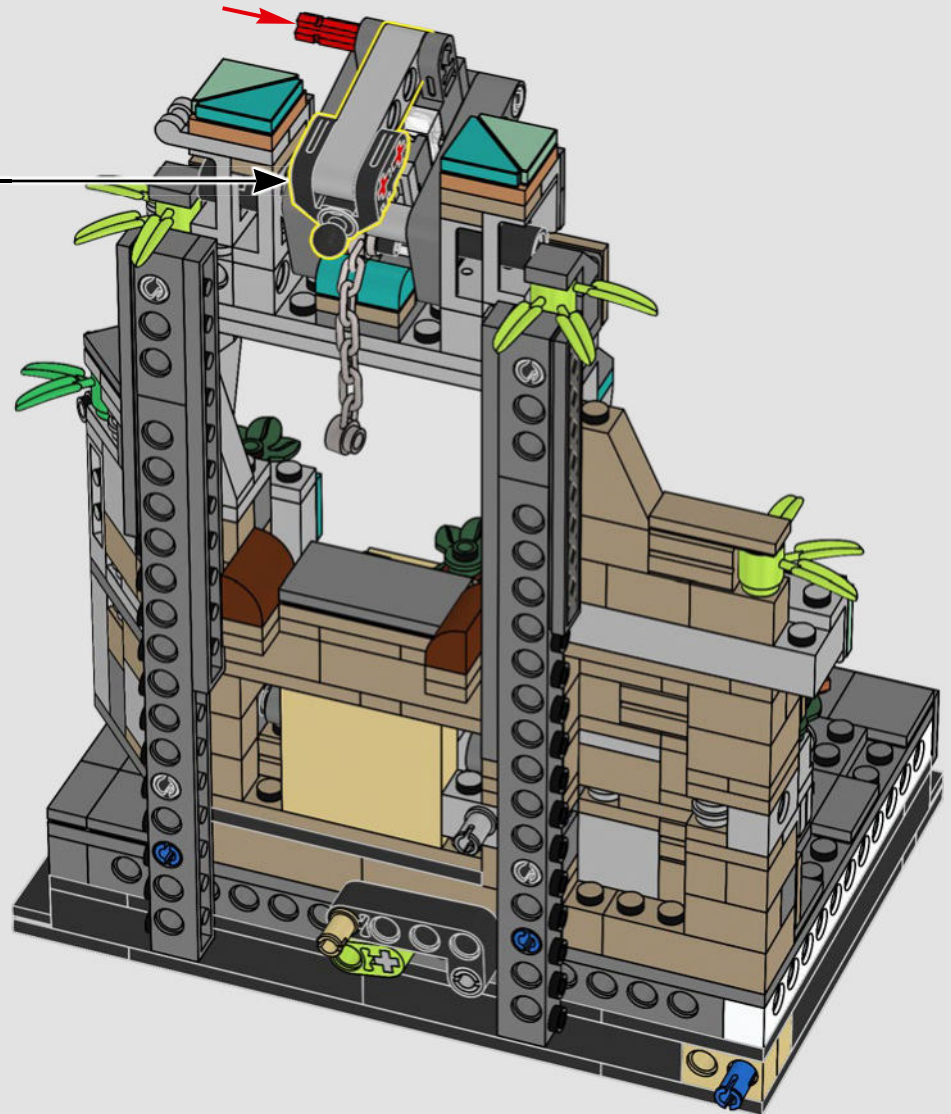
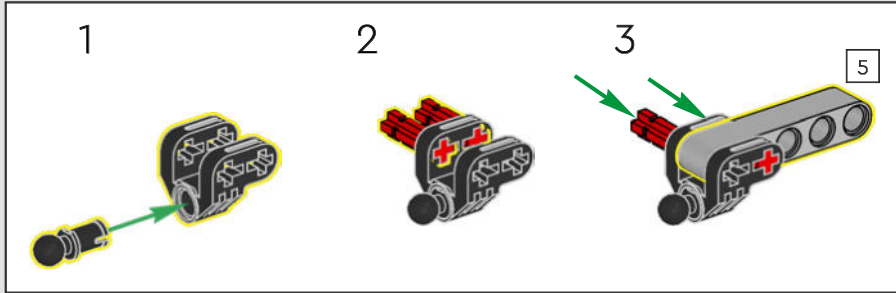

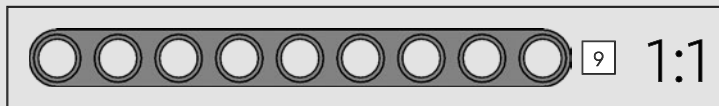
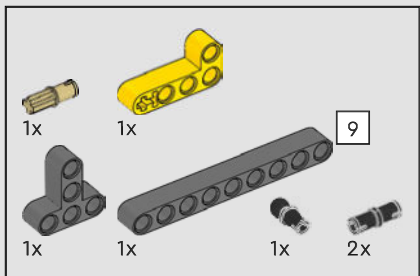

362

1

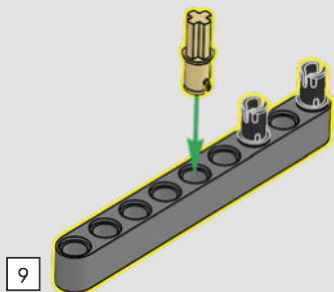

2

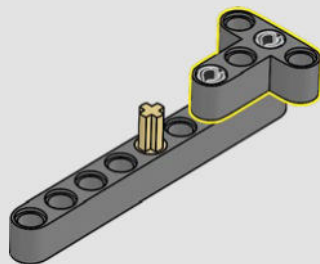

3

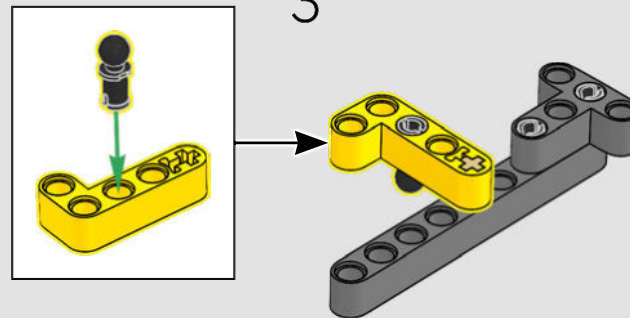

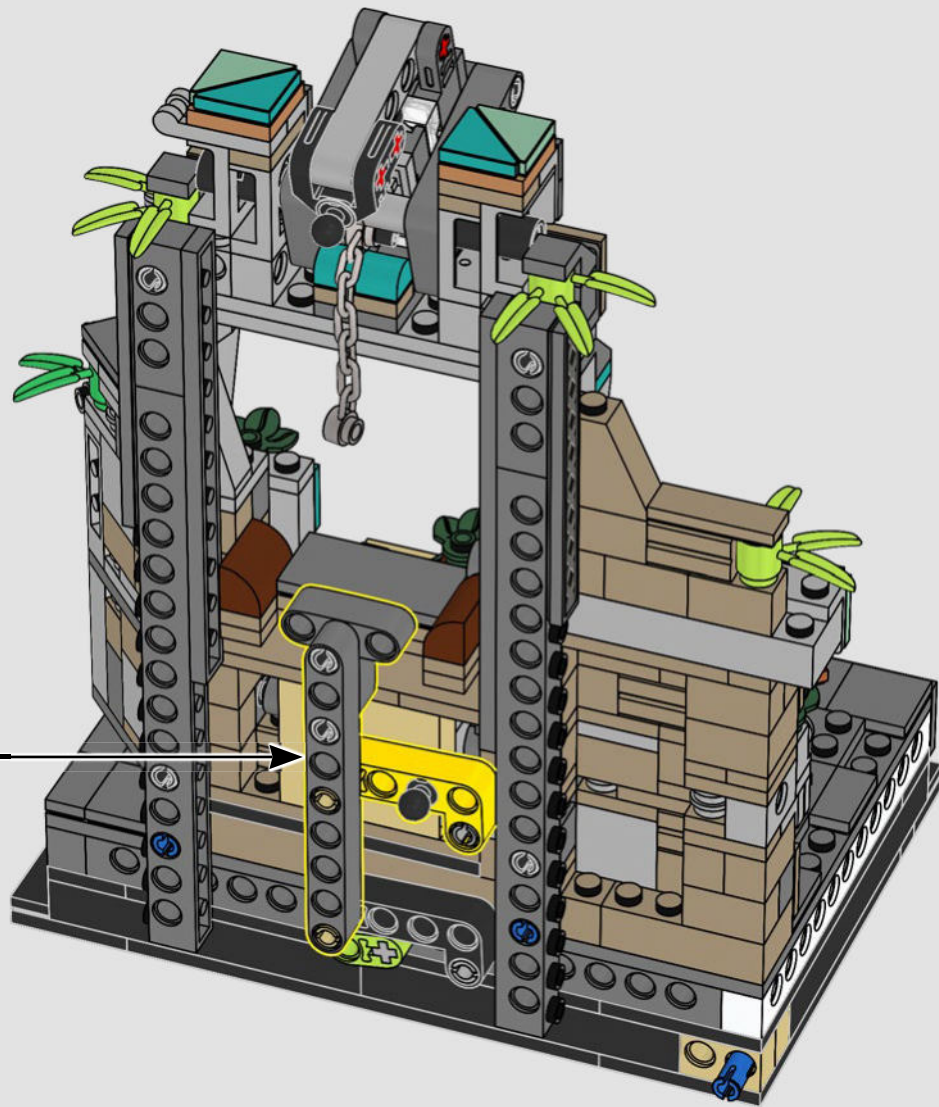

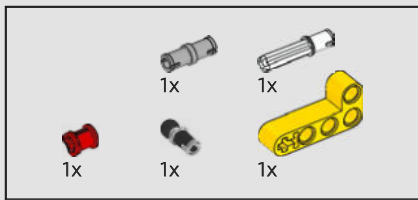

363

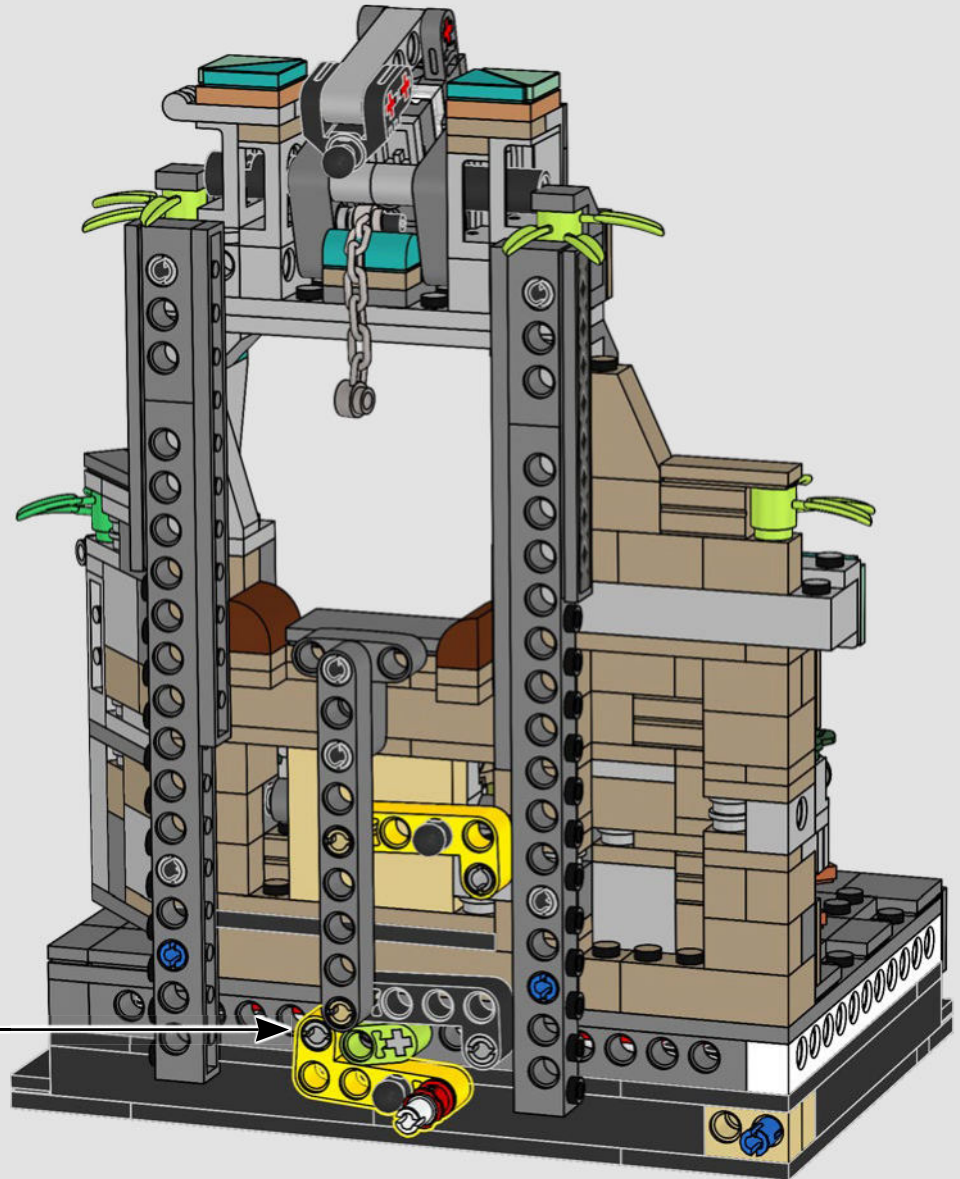
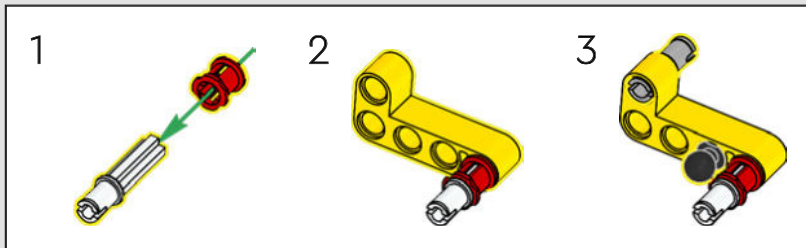
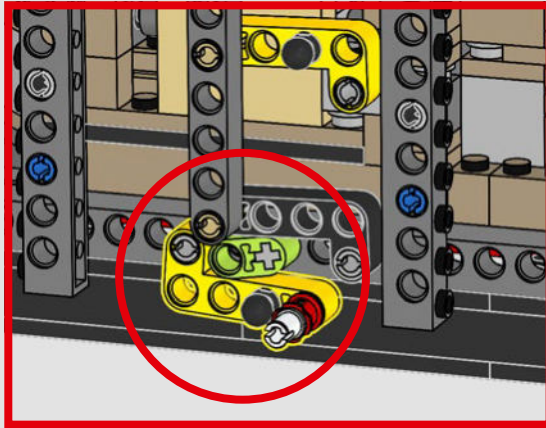

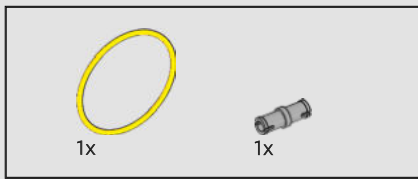

364

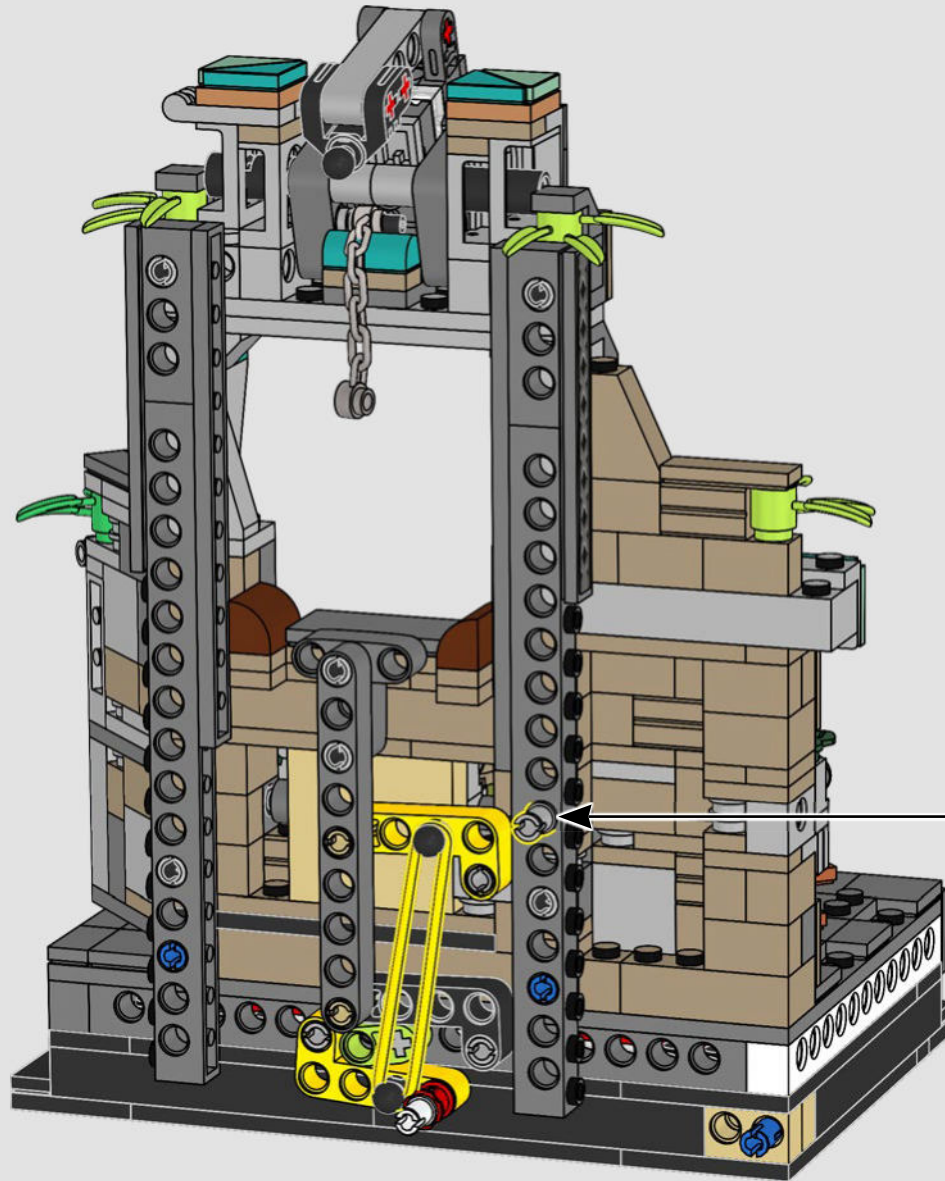

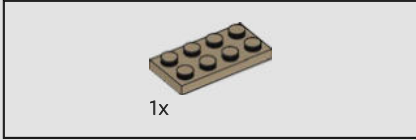

365

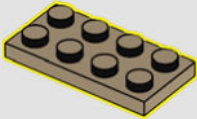

366

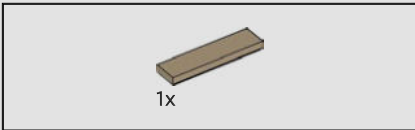
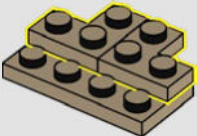

367

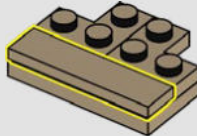

368

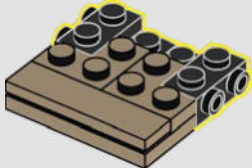

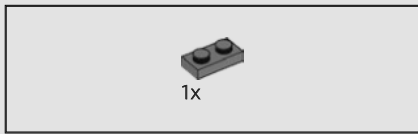

369

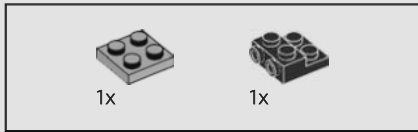
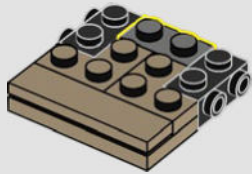

370

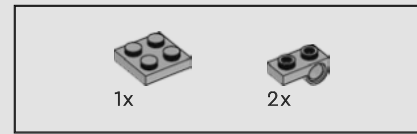
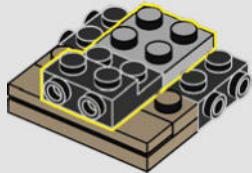

371

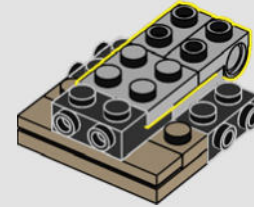

372

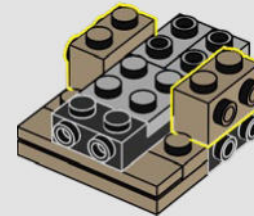

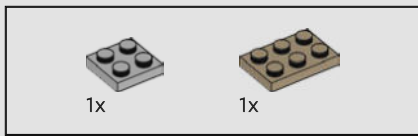

373

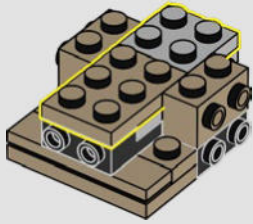

374

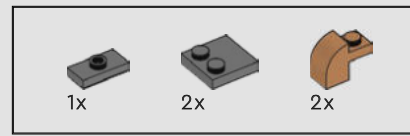
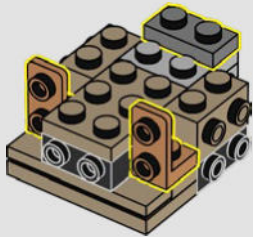

375

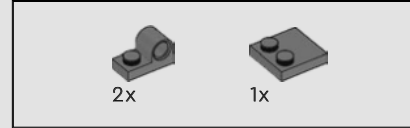
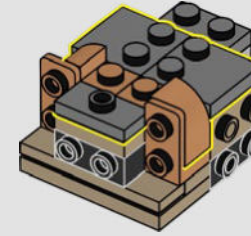

376

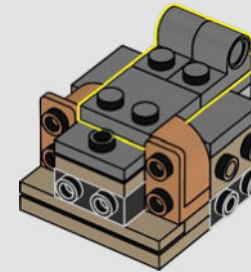

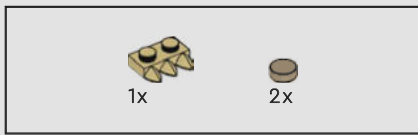

377

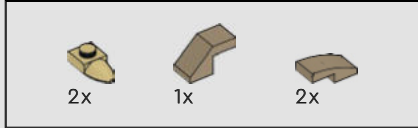
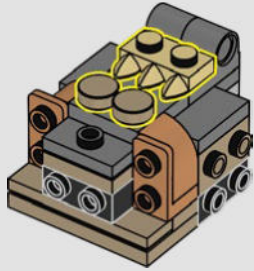

378

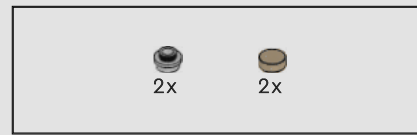
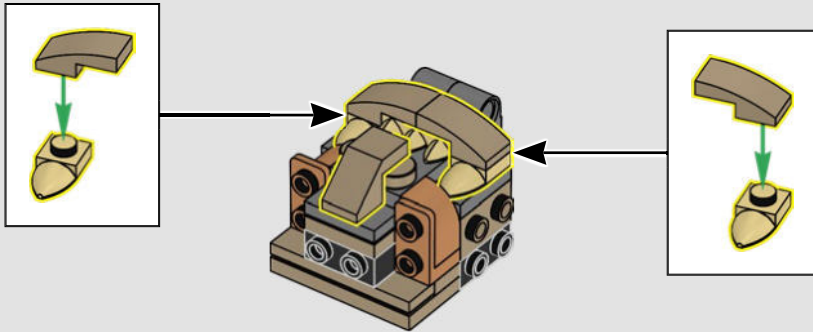

379

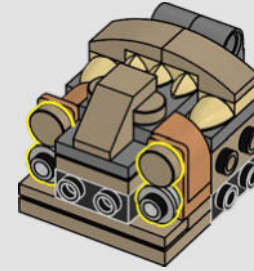

380

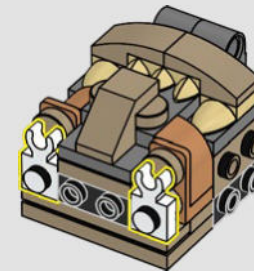



381

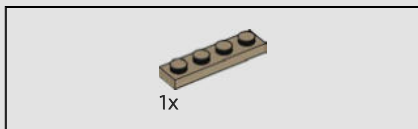
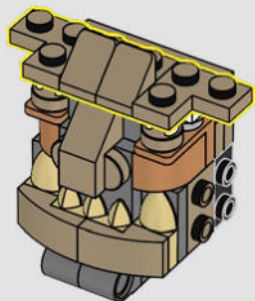

382

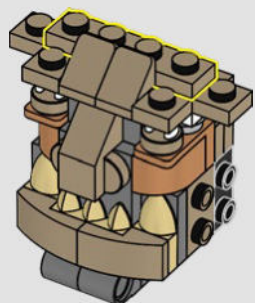

383

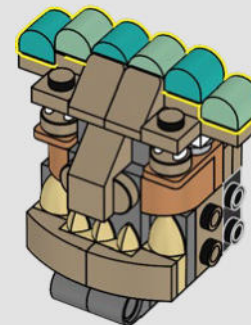

384

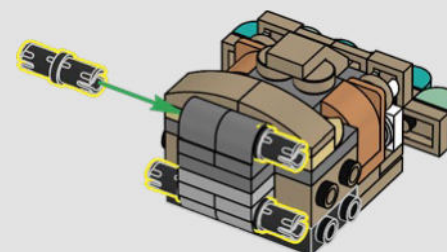

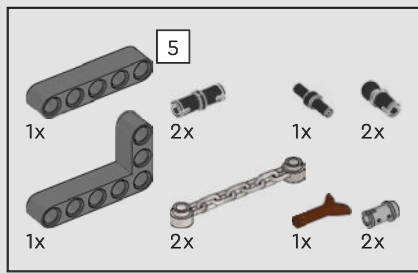

385

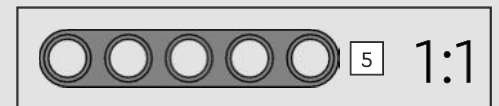
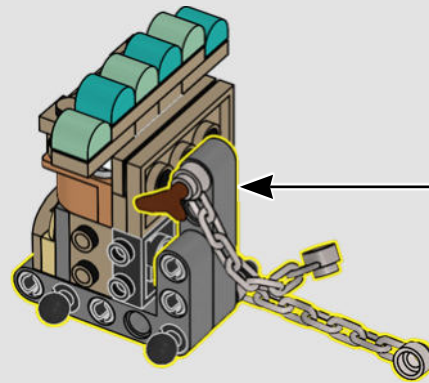
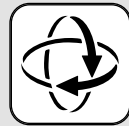
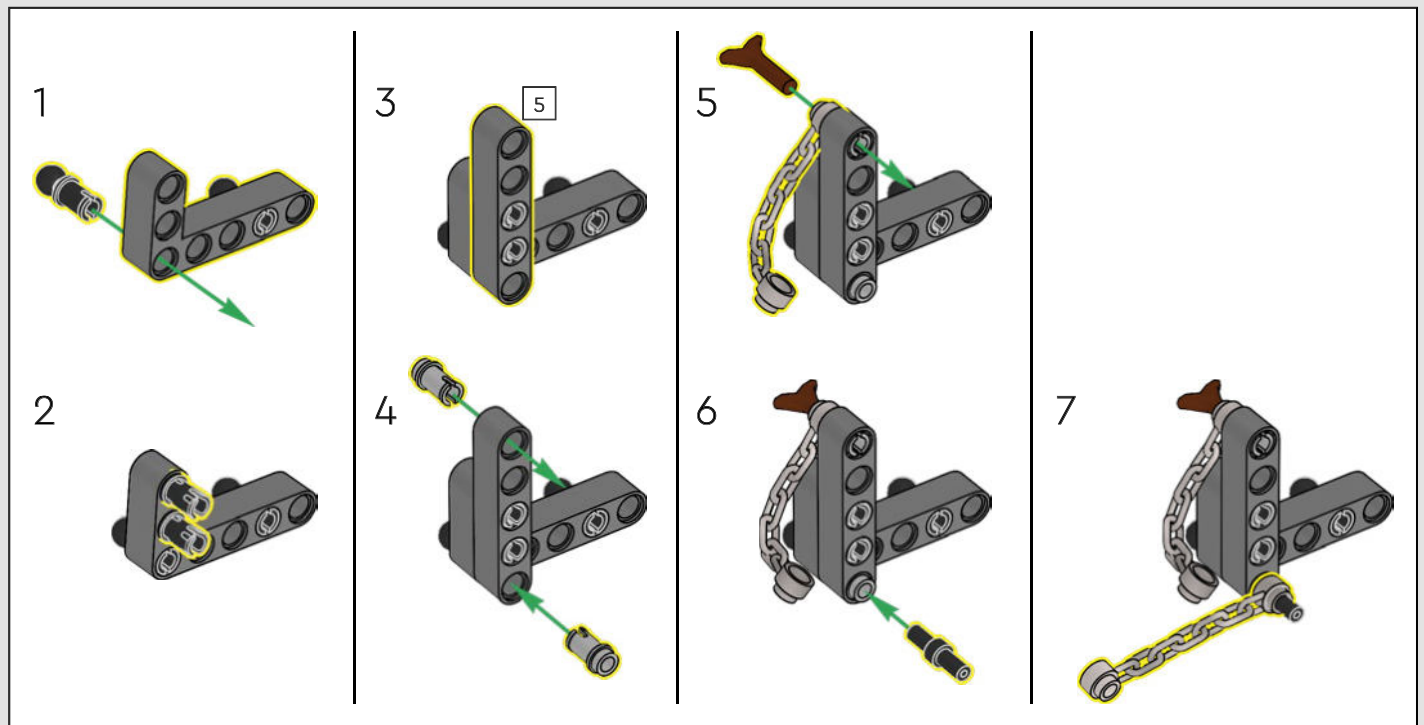

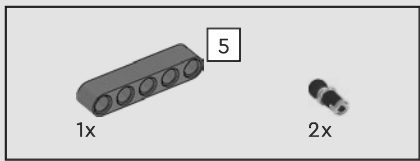

386

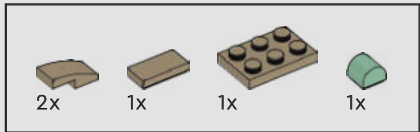
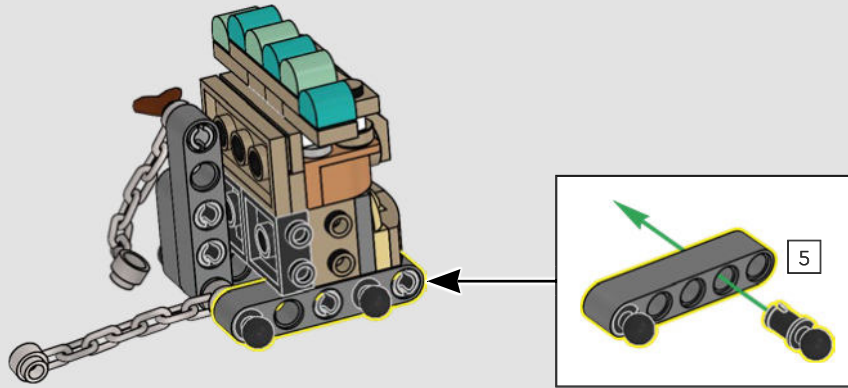

387

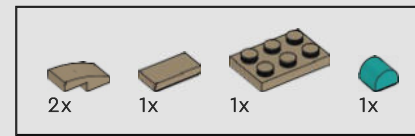
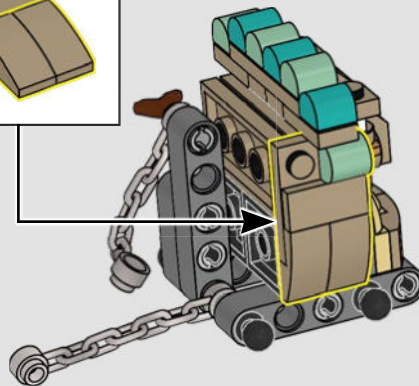
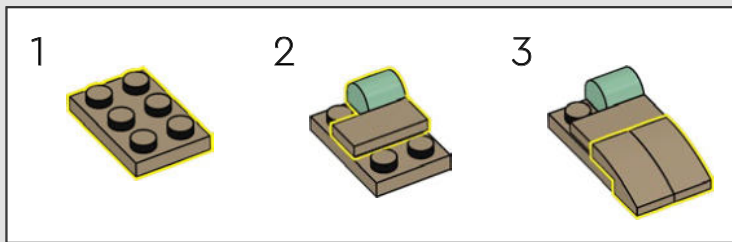

388

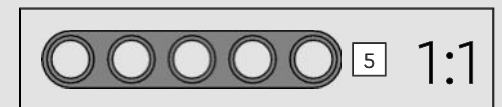
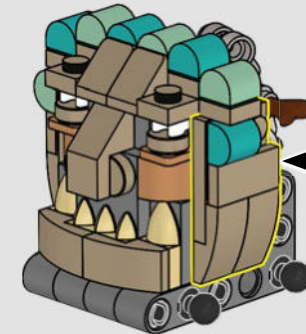
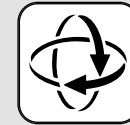
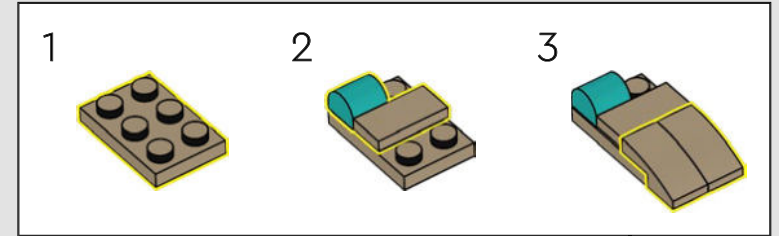

389



1x

390

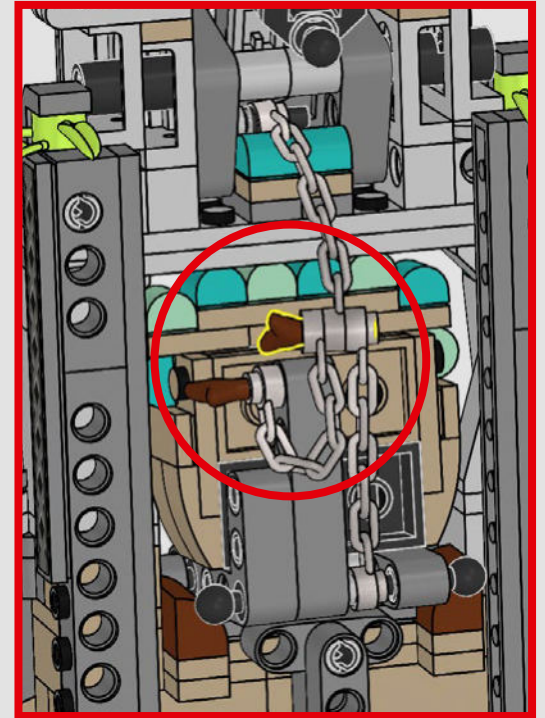
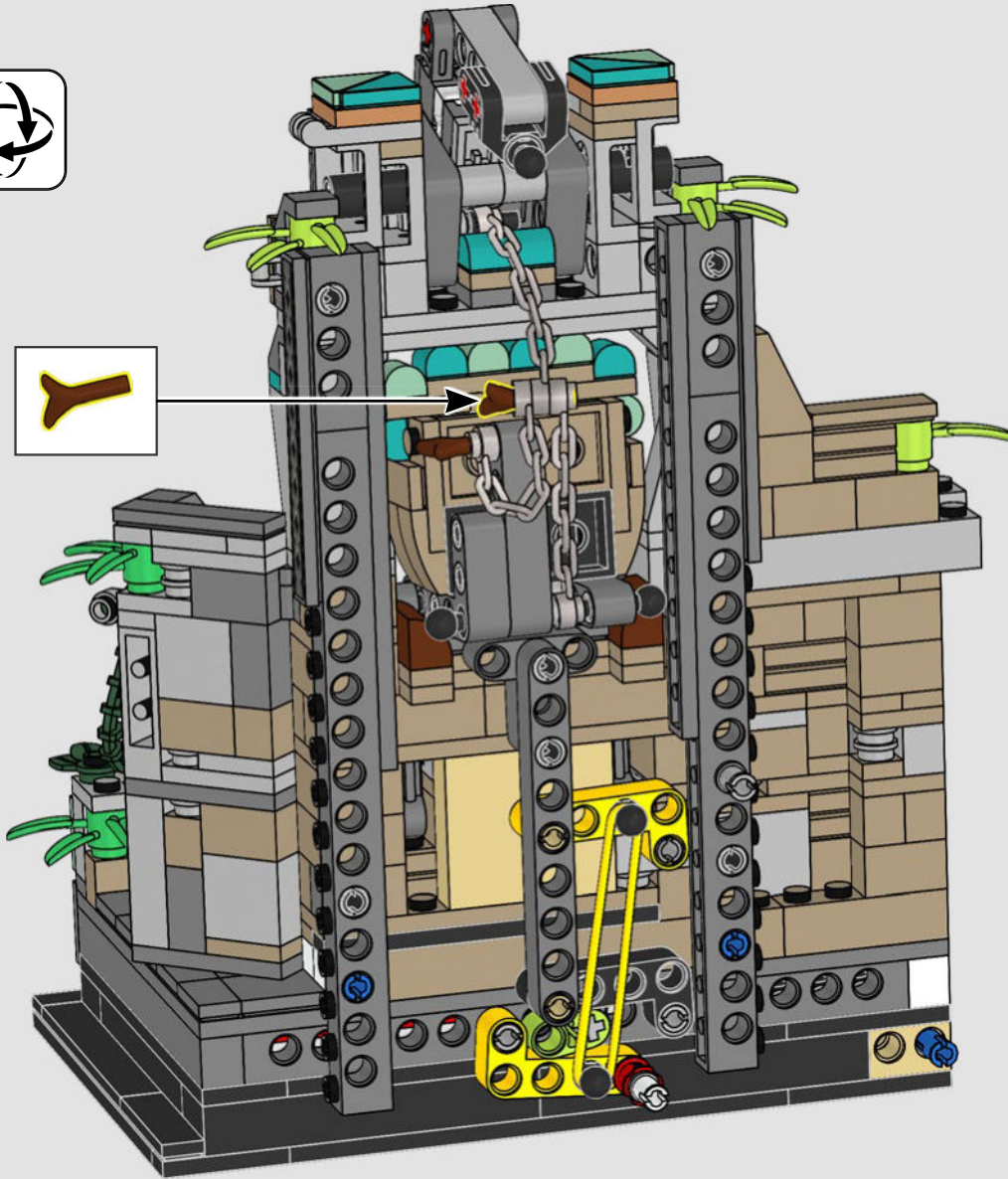

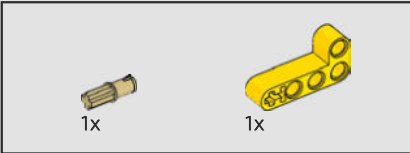
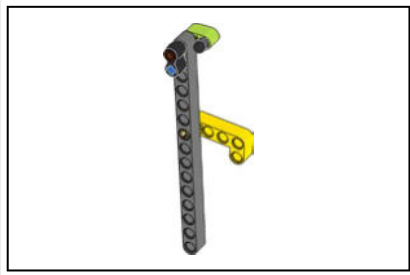

391

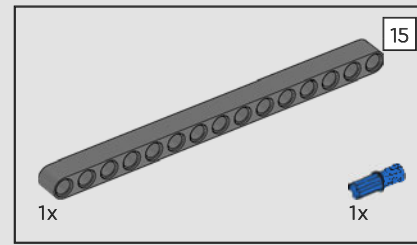
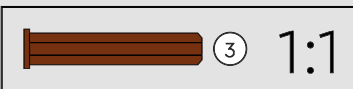
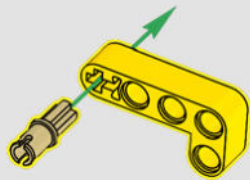

392

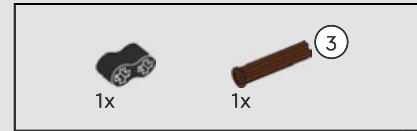
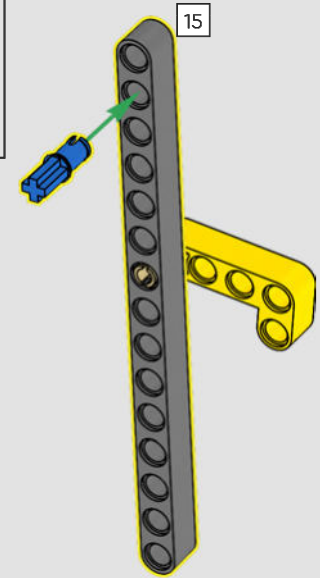

393

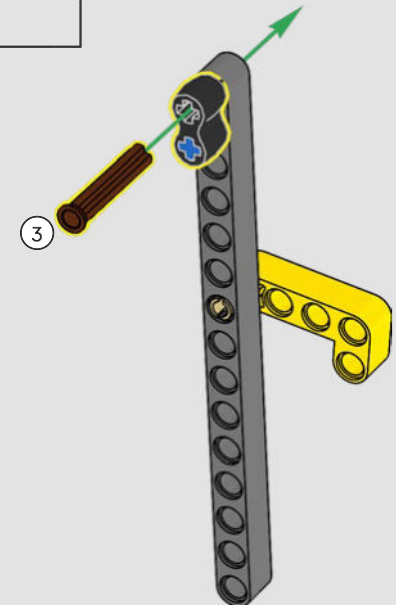



394

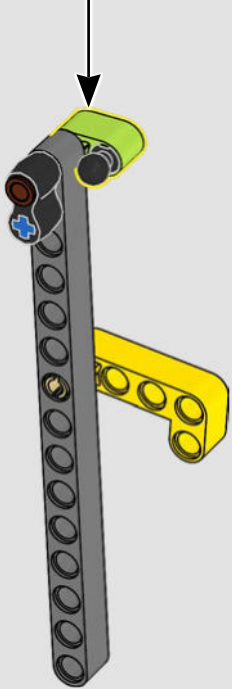
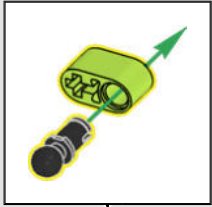

395

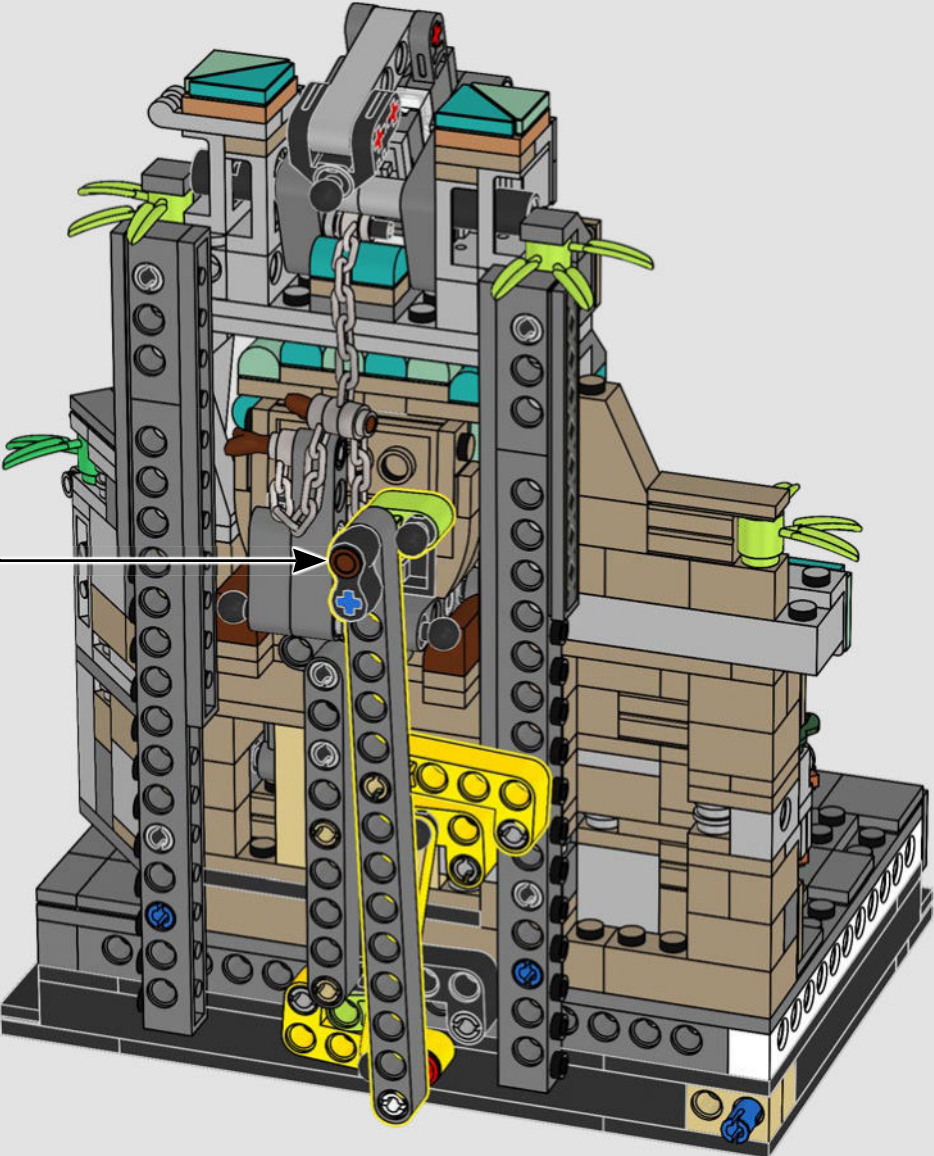

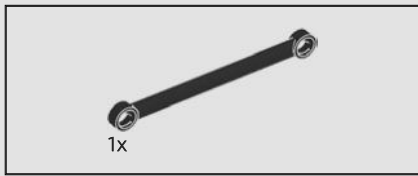

396

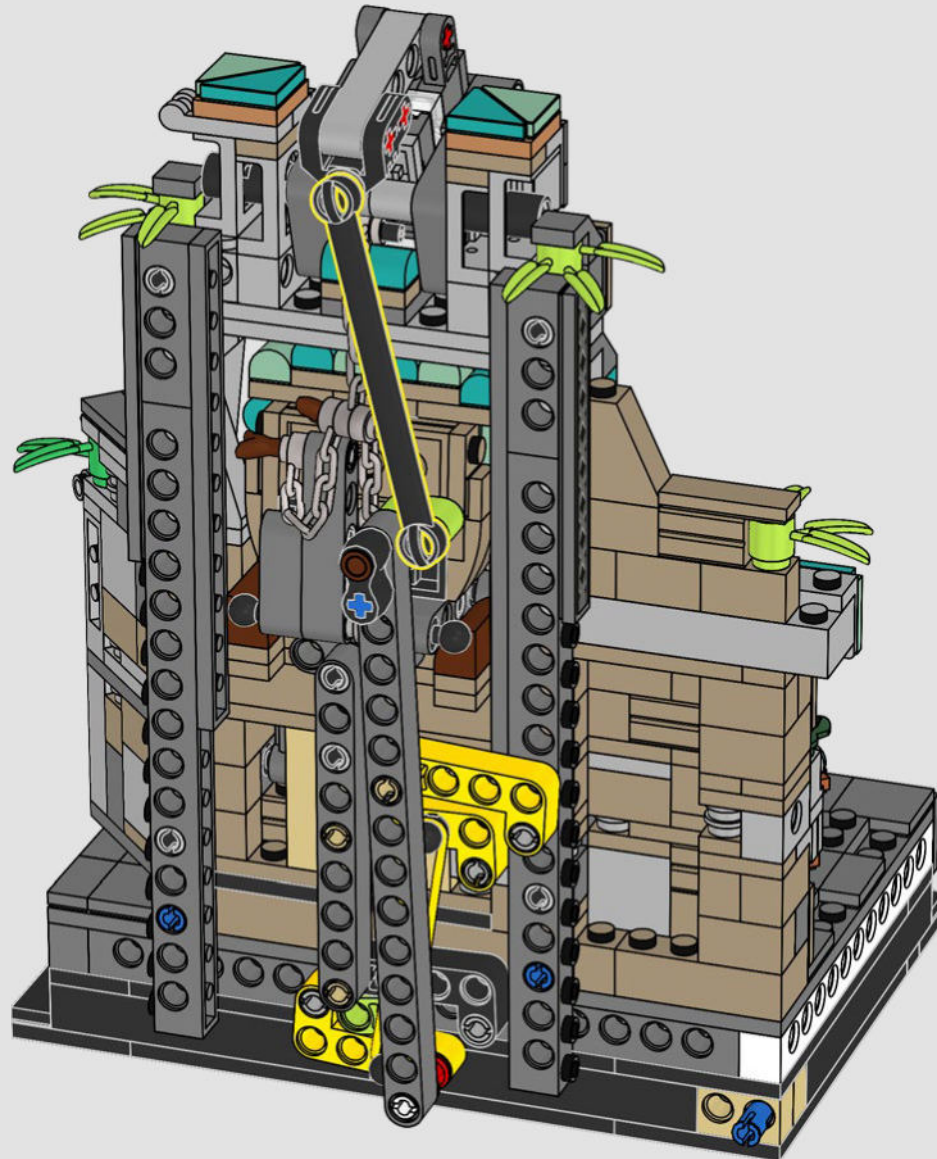



397

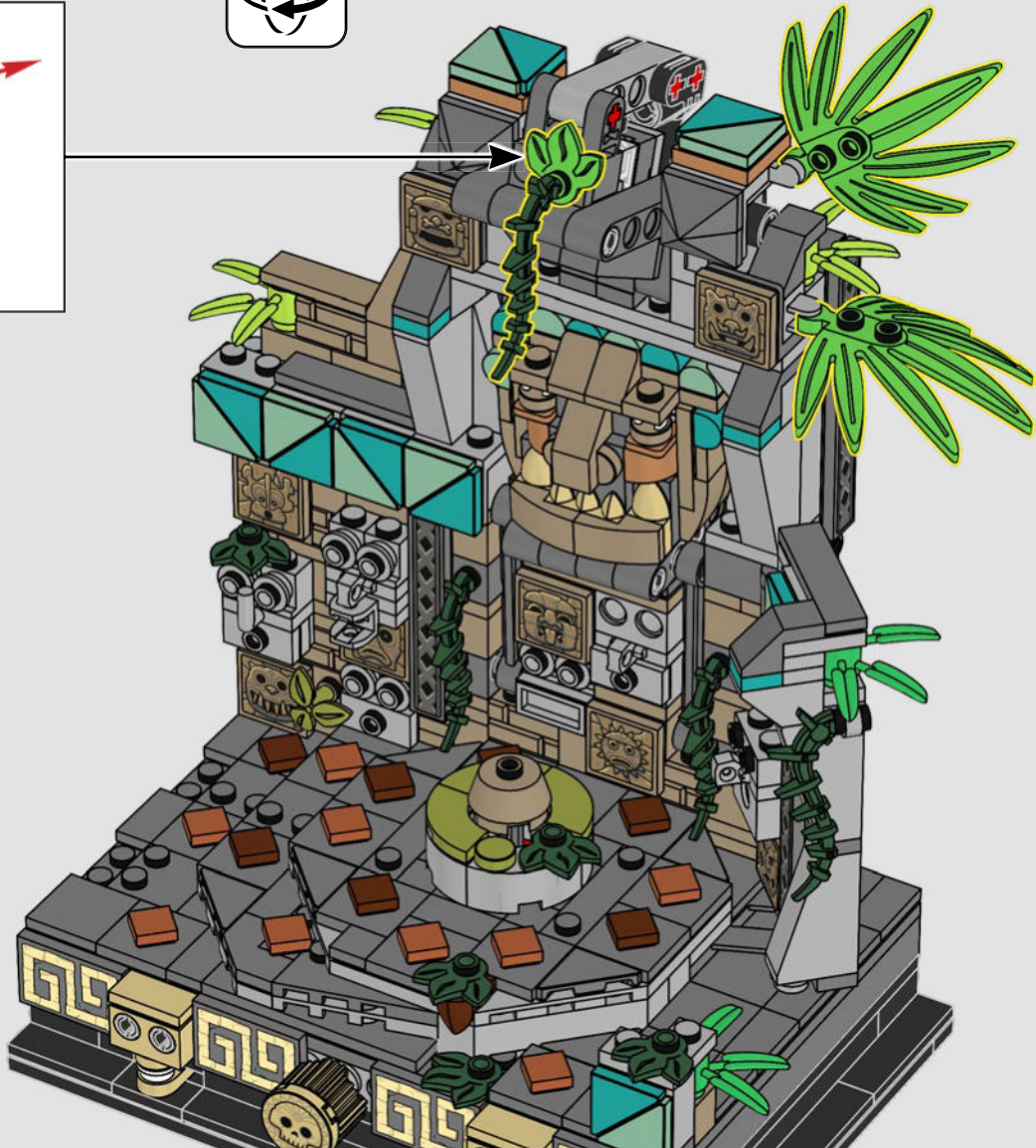
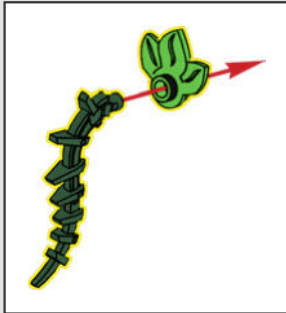

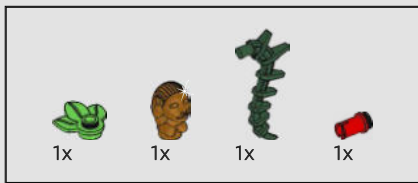

398

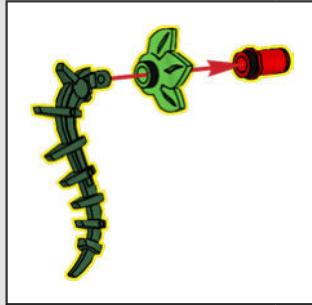



399



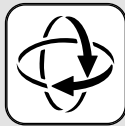
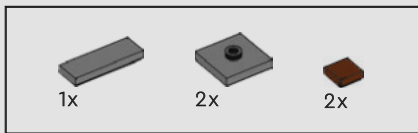

400

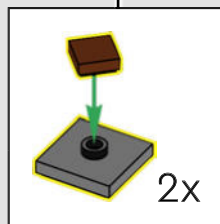
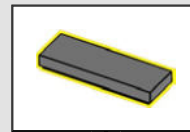





1050021-M

EN**Important information about batteries**

Never use different types of batteries together, or a combination of old and new batteries. Always remove the batteries if the product is not to be used for a long time or if the batteries have run down. Never use damaged batteries. Only use alkaline type batteries. Insert the batteries so that the poles are correctly positioned. Never attempt to recharge non-rechargeable batteries. Never short-circuit the battery holder.

DE**Wichtige Informationen zu Batterien**

Benutzen Sie niemals unterschiedliche Arten von Batterien oder alte und neue gleichzeitig. Nehmen Sie stets die Batterien heraus, wenn mit dem Modell längere Zeit nicht gespielt wird oder wenn die Batterien leer sind. Verwenden Sie niemals beschädigte Batterien. Verwenden Sie ausschließlich Alkali-Batterien. Achten Sie beim Einsetzen der Batterien auf die richtige Polung. Versuchen Sie unter keinen Umständen, „normale“ Batterien wieder aufzuladen. Schließen Sie das Batteriefach niemals kurz.

FR**Informations importantes concernant les piles**

Ne jamais utiliser un mélange de différents types de piles, ou de piles neuves et de piles anciennes ou déjà utilisées. Toujours retirer les piles si le produit n'est pas utilisé durant une période prolongée ou si les piles sont vides. Ne jamais utiliser de piles endommagées. N'utiliser que des piles alcalines. En insérant les piles, respecter scrupuleusement le sens d'orientation des pôles (+/-). Ne jamais essayer de recharger des piles non rechargeables. Ne jamais court-circuiter le compartiment des piles.

IT**Importanti informazioni sulle batterie**

Non usare mai contemporaneamente batterie di tipo diverso o batterie nuove e usate insieme. Rimuovere sempre le batterie qualora il prodotto non venga utilizzato per periodi prolungati, oppure se le batterie sono esauste. Non utilizzare mai batterie danneggiate. Utilizzare solo batterie di tipo alcalino. Inserire le batterie avendo cura che la loro polarità sia corretta. Non tentare mai di ricaricare batterie non ricaricabili. Non cortocircuitare mai il portabatterie.

NL**Belangrijke informatie over batterijen**

Gebruik nooit verschillende soorten of een combinatie van oude en nieuwe batterijen tegelijkertijd. Verwijder de batterijen altijd als je het product lange tijd niet wilt gebruiken of als batterijen leeg zijn. Gebruik nooit beschadigde batterijen. Gebruik alleen alkalinebatterijen. Plaats de batterijen met de polen in de juiste richting. Probeer nooit niet-oplaadbare batterijen opnieuw op te laden. Laat de batterijhouder nooit kortsluiten.

ES**Información importante acerca de las pilas**

No use pilas de diferentes tipos ni pilas nuevas y antiguas para alimentar el producto. Extraiga las pilas del producto si este va a permanecer sin uso durante un período prolongado de tiempo o aquellas se han agotado. No use pilas dañadas. Use solo pilas alcalinas. Inserte las pilas de modo que los polos queden situados en las posiciones correctas. No trate de cargar pilas no recargables. No cortocircuite el compartimento de las pilas.

DA**Vigtige oplysninger om batterier**

Brug aldrig forskellige batterityper sammen eller en kombination af gamle og nye batterier. Fjern altid batterierne, hvis produktet ikke skal bruges i lang tid, eller hvis batterierne er flade. Brug aldrig beskadigede batterier. Brug kun alkaliske batterier. Sæt batterierne i, så polerne vender den rigtige vej. Forsøg aldrig at oplade ikke-genopladelige batterier. Kortslut aldrig batteriholderen.

IS**Mikilvægar upplýsingar um rafhlöður**

Aldrei skal nota mismunandi gerðir rafhlaðna samtímis, né nýjar og eldri rafhlöður samtímis. Ef ekki á að nota tækið í lengri tíma eða ef rafhlöðurnar eru orðnar tómar skal fjarlægja rafhlöðurnar. Aldrei skal nota rafhlöður sem hafa skemmt. Eingöngu má nota alkaline-rafhlöður. Setja skal rafhlöðurnar í þannig að plús- og mínusskaut þeirra snúi rétt. Aldrei skal reyna að endurhlaða rafhlöður sem ekki eru endurhlaðanlegar. Aldrei ætti að valda skammhlaupi í rafhlöðuhólfnum.

FI**Tärkeää tietoa paristoista**

Älä koskaan käytä erityyppisiä paristoja yhdessä. Älä myöskään käytä samassa laitteessa sekä vanhoja että uusia paristoja. Poista paristot tuotteesta aina, kun se on pitemmän aikaa käyttämättä, tai kun paristot ovat tyhjentyneet. Älä koskaan käytä viallisia paristoja. Käytä vain alkaliparistoja. Aseta paristot siten, että navat osoittavat oikeaan suuntaan. Älä koskaan aiheuta oikosulkua pariston kosketinten välillä.

SV**Viktig information om batterier**

Använd aldrig olika sorters batterier samtidigt, och inte heller en kombination av gamla och nya batterier. Ta alltid ur batterierna om produkten inte ska användas under en längre tid eller om batterierna är slut. Använd aldrig skadade batterier. Använd endast alkaliska batterier. Sätt i batterierna så att polerna hamnar i rätt läge. Försök aldrig ladda icke-laddningsbara batterier. Kortslut aldrig batteriutrymmets kontaktytor.

NO**Viktig informasjon om batterier**

Bruk aldri ulike typer batterier sammen og heller aldri gamle og nye batterier sammen. Ta alltid ut batteriene hvis produktet ikke skal brukes på lang tid, eller hvis batteriene er brukt opp. Bruk aldri skadde batterier. Bruk bare alkaliske batterier. Sett inn batteriene med polene vendt riktig vei. Forsøk aldri å lade opp ikke-oppladbare batterier. Kortslett aldri batteriholderen.

PT**Informação importante sobre as pilhas**

Nunca use diferentes tipos de pilhas em simultâneo, ou uma combinação de pilhas usadas e novas. Retire sempre as pilhas se o produto não for usado durante muito tempo ou se as pilhas já não tiverem carga. Nunca use pilhas danificadas. Use apenas pilhas alcalinas. Insira as pilhas de forma a que os polos fiquem corretamente posicionados. Nunca tente recarregar pilhas não recarregáveis. Nunca deite o compartimento das pilhas entrar em curto-circuito.

EL

Σημαντικές πληροφορίες για τις μπαταρίες

Μην χρησιμοποιείτε ποτέ διαφορετικούς τύπους μπαταριών μαζί και μην συνδυάζετε παλιές και καινούργιες μπαταρίες. Αφαιρείτε πάντα τις μπαταρίες αν δεν σκοπεύετε να χρησιμοποιήσετε το προϊόν για αρκετό καιρό ή αν οι μπαταρίες έχουν αδειάσει. Ποτέ μην χρησιμοποιείτε μπαταρίες που έχουν φθορές. Χρησιμοποιείτε μόνο αλκαλικές μπαταρίες. Τοποθετήστε τις μπαταρίες με τους πόλους στη σωστή θέση. Μην επιχειρήσετε ποτέ να επαναφορτίσετε μη επαναφορτιζόμενες μπαταρίες. Ποτέ μην βραχυκυκλώνετε τη θήκη των μπαταριών.

JA

電池取扱に関する重要事項

異なるタイプの電池や古い電池を混ぜて使用しないでください。商品を長時間使用しないときや電池が切れたときは、電池を必ず取り外してください。不具合のある電池は絶対に使用しないでください。アルカリタイプの電池のみを使用してください。電極を確認して電池を正しい向きに入れてください。充電式ではない電池は絶対に充電しないでください。電池ホルダをショートさせないでください。

ZH

電池使用注意事項

请勿同时使用不同类型的电池，或把新旧程度不同的电池混合使用。如果产品将有很长时间不会使用，或者电池已经没电，请注意取出电池。切勿使用已破损的电池。仅可使用碱性电池。装入电池时请注意正负极。请勿尝试给非充电电池充电。切勿对电池仓进行短路连接。

KO

배터리 사용 시 주의사항

다른 종류의 배터리를 함께 사용하거나, 새 전자와 오래된 전지를 혼용하지 마세요. 배터리가 방전되었거나 장기간 제품을 작동하지 않을 때에는 반드시 배터리를 분리하세요. 파손된 배터리는 사용하지 마세요. 알칼라인 타입의 배터리만을 사용하세요. 양극과 음극의 위치를 잘 맞춰서 넣으세요. 일반 배터리는 충전해서 사용할 수 없습니다. 배터리 홀더의 접촉부에 배터리를 정확히 끼워서 사용하세요.

RU

Необходимая информация об элементах питания

Ни в коем случае не используйте одновременно элементы питания различных типов, а также элементы питания с разным сроком годности. В обязательном порядке вынимайте элементы питания из терминалов в случае, если вы не пользуетесь прибором в течение долгого времени, либо в случае, если в элементах питания закончился заряд. Ни в коем случае не используйте поврежденные элементы питания. Используйте только элементы питания щелочного типа. Установите элементы питания, соблюдая указанную полярность. Ни в коем случае не пытайтесь подзарядить перезаряжаемые элементы питания. Ни в коем случае не пытайтесь замкнуть полюса в устройстве для элементов питания.

PL

Ważne informacje dotyczące baterii

Nigdy nie należy stosować razem różnych rodzajów baterii ani stosować równocześnie starych i nowych baterii. Jeżeli produkt nie jest używany przez dłuższy czas lub jeżeli baterie się wyczerpały, należy wyjąć baterie. Nigdy nie należy stosować uszkodzonych baterii. Należy używać wyłącznie baterii alkalicznych. Przy wkładaniu baterii należy zwrócić uwagę na właściwe połączenie biegunów. Nigdy nie należy próbować ładowania baterii jednorazowych. Nigdy nie należy doprowadzać do zwarcia w gnieździe baterii.

CZ

Důležitá informace o bateriích

Nikdy nepoužívejte najednou různé typy baterií nebo kombinaci starých a nových baterií. Nebude-li se výrobek delší dobu používat nebo jsou-li baterie vybité, vždy je vyjměte z výrobku. Nikdy nepoužívejte poškozené baterie. Používejte pouze alkalické baterie. Baterie instalujte se správnou orientací pólů. Nikdy se nesnažte nabíjet baterie, které nejsou nabíjitelné. Nikdy nezkratujte kontakty v prostoru pro baterie.

SK

Dôležitá informácia o batériách

Nikdy nepoužívajte naraz odlišné typy batérií ani nekombinujte staré batérie s novými. Batérie vždy vyberte, ak sa výrobok nebude dlhšie používať, alebo ak sa batérie vybili. Nikdy nepoužívajte poškodené batérie. Používajte iba alkalické batérie. Batérie vkladajte so správnou orientáciou pólou. Nikdy sa nesnažte nabíjať batérie, ktoré nie sú nabíjateľné. Nikdy neskratuje kontakty v priestore pre batérie.

HU

Fontos tudnivalók az elemekről

Soha ne használjon különböző típusú elemeket, illetve ne használjon vegyesen új és használt elemeket. Mindig távolítsa el az elemeket, ha a készüléket előre láthatóan hosszabb ideig nem fogják használni, vagy ha az elemek lemerültek. Soha ne használjon megrongálódott elemeket. Csak alkáli elemeket használjon! Az elemeket helyesen helyezze be, a polaritásuknak megfelelően. Soha ne próbálja meg feltölteni a nem tölthető elemeket. Soha ne hozzon létre rövidzárlatot az elemtartó kivezetéssein.

UA

Необхідна інформація про батареїки

Ніколи не використовуйте одночасно батареїки різних типів або батареїки з різним терміном придатності. Обов'язково вилучайте батареїки з приладу, якщо довго не користуетесь ним, або якщо в батареїках уже скінчився заряд. Ніколи не використовуйте пошкоджені батареїки. Використовуйте лише лужні батареїки. Вставляйте батареїки, враховуючи задану полярність. У будь-якому випадку не намагайтеся підзарядити батареїки, що не підлягають підзарядці. У будь-якому випадку не намагайтеся зробити коротке замикання в приладі для батареї.

HR

Važne obavijesti o bateriji

Nikada nemoj koristiti različite vrste baterija zajedno, isto tako ni kombinaciju starih i novih baterija. Uvijek izvadite baterije ako dugo nećeš koristiti proizvod ili ako su one potrošene. Nikada nemoj koristiti oštećene baterije. Uputrebljavajte samo alkalne baterije. Umetni baterije pazeći da dobro okreneš polove. Nikada ne pokušavaj puniti baterije koje nisu predviđene za punjenje. Nikada ne izazivaj kratki spoj u držaču baterija.

SR

Важне информације о батеријама

Никада не користите различите типове батерија заједно нити комбинацију старих и нових батерија. Увек извадите батерије уколико производ нећете дуже време користити или уколико су батерије празне. Никада не користите оштећене батерије. Користите само алкалне батерије. Ставите батерије тако да су полови правилно позиционирани. Никада не покушавајте да пуните батерије које не могу да се пуне. Никада не изазивајте кратак spoj у кућишту за батерије.

МК

Важни информации за батериите

Никогаш не користете различни типови батериии заедно или комбинација од стари и нови батериии. Секогаш отстранувајте ги батериите доколку не го користите производот подолго време или доколку се потрошиле. Никогаш не користете оштетени батериии. Користете само алкални батериии. Вметнете ги батериите така што точно ќе ги наместите половите. Никогаш не обидувајте се да ги полните батериите за еднократна употреба. Никогаш не предизвикувајте краток спој на држачот за батериии.

SL

Pomembne informacije o baterijah

Nikoli ne uporabljajte skupaj različnih baterij ali kombinacije starih in novih baterij. Vedno odstranite baterije, če izdelka dlje časa ne boste uporabljali ali če so iztrošene. Nikoli ne uporabljajte poškodovanih baterij. Uporabljajte le alkalne baterije. Baterije vstavite tako, da so njihovi poli pravilno obrnjeni. Nikoli ne poskušajte polniti baterij, ki niso akumulatorske. Pazite, da ležišč za baterije ne boste spravili v kratek stik.

RO

Informații importante despre baterii

Nu folosiți niciodată împreună tipuri diferite de baterii, sau o combinație de baterii vechi și noi. Îndepărtați întotdeauna bateriile dacă produsul nu este folosit timp îndelungat sau dacă bateriile s-au epuizat. Nu folosiți niciodată baterii deteriorate. Utilizați numai baterii de tip alcalin. Introduceți bateriile astfel ca polii să fie poziționați corect. Nu încercați niciodată să reîncărcați baterii nereîncărcabile. Nu scurtcircuitați niciodată suportul bateriei.

BG

Важна информация за батериите

Никога не използвайте едновременно различни типове батериии или комбинация от стари и нови батериии. Винаги изваждайте батериите, ако изделието няма да се използва продължително време или ако батериите са се изтозили. Никога не използвайте повредени батериии. Използвайте само алкални батериии. Поставете батериите така, че полюсите да са разположени правилно. Никога не опитвайте да зареждате батериии, които не са акумулаторни. Никога не свързвайте на късо контактите на отделението за батериите.

LV

Svarīga informācija par baterijām

Nekad vienlaikus nelietojiet dažādu tipu, kā arī vecas un jaunas baterijas. Vienmēr izņemiet baterijas, ja tās ir izlādējušās vai ja produkts ilgāku laiku netiek lietots. Nekad nelietojiet bojātas baterijas. Izmantojiet tikai sārma tipa baterijas. Ievietojot baterijas, ievērojiet pareizu polaritāti. Nekad nemēģiniet uzlādēt baterijas, kas nav uzlādējamās. Nepieļaujiet savienojumu bateriju nodalījumā.

ET

Oluline teave patareide kohta

Ära kunagi kasuta koos erinevat tüüpi patareisid, samuti vanu ja uusi patareisid. Kui mänguasja ei kasutata pika aja jooksul, võta patarei sellest välja. Ära kunagi kasuta kahjustatud patareisid. Kasuta ainult leelispatareisid. Pane patareid mänguasja sisse nii, et pluss- ja miinusklemmi asend oleks õige. Ära kunagi proovi akulaadijaga laadida tavalisi patareisid. Patareipesa klemmide vahel ei tohi tekkida lühist.

LT

Svarbi informacija apie elementus

Vienu metu nenaudokite skirtingų elementų, taip pat su naujais elementais nenaudokite senų. Jei nenaudosite gaminio ilgesnį laiką arba jei elementai išseko, visuomet išimkite juos iš gaminio. Niekada nenaudokite pažeistų elementų. Naudokite tik šarminius elementus. Elementus dėkite atsižvelgdami į jų poliškumą. Niekada nebandykite įkrauti vienkartinį elementų. Saugokitės, kad elementų įdėkle nesukeltumėte trumpojo jungimo.

TR

Piller hakkında önemli bilgiler

Hiçbir zaman farklı tipte pilleri ya da eski pillerle yeni pilleri bir arada kullanmayın. Ürün uzun süre kullanılmayacaksa ya da piller bitmişse, pilleri ürünün içinden çıkarın. Hiçbir zaman zedelenmiş piller kullanmayın. Sadece alkalin piller kullanın. Pilleri kutupları doğru konumda olacak şekilde yerleştirin. Hiçbir zaman, şarj edilebilir olmayan pilleri şarj etmeye çalışmayın. Hiçbir zaman pil kutusuna kısa devre yaptırmayın.

AR

معلومات مهمة عن البطاريات

يحظر استخدام أنواع مختلفة من البطاريات معا أو مزيج من البطاريات القديمة و الجديدة. أحرص دائما على نزع البطاريات في حال عدم استخدام المنتج لفترة طويلة أو إذا نفذت طاقة البطاريات. تجنب استخدام البطاريات التالفة. لا تستخدم إلا البطاريات القلوية فقط. قم بتكيب البطاريات بحيث تكون الأقطاب في موضعها الصحيح. يحظر إعادة شحن البطاريات غير القابلة لإعادة الشحن. تجنب إحداث دائرة قصر في حامل البطارية.

ID

Informasi penting tentang baterai

Jangan gunakan baterai yang jenisnya berlainan, atau mencampur baterai lama dan baterai baru. Lepas baterai jika produk tidak akan digunakan untuk waktu lama atau jika baterai sudah lemah. Jangan gunakan baterai yang rusak. Gunakan hanya baterai alkali. Masukkan baterai dengan posisi kutub yang tepat. Jangan pernah coba mengisi ulang baterai biasa. Jangan pernah membuat arus pendek pada dudukan baterai.

MS

Maklumat penting tentang bateri

Jangan guna jenis bateri yang berbeza bersama-sama, atau gabungan bateri baharu dan lama. Tanggalkan bateri jika produk tidak akan digunakan untuk tempoh masa yang lama atau jika bateri telah kehabisan kuasa. Jangan guna bateri yang rosak. Guna bateri jenis alkali sahaja. Selitkan bateri supaya paksi berada pada kedudukan yang betul. Jangan cuba untuk mengecap semula bateri yang tidak boleh dicaskan semula. Jangan pintas liter pemegang bateri.

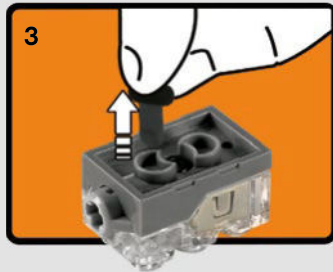

1:1
2x LR 41 1.5V



EN
WARNING: This product contains a Button or Coin Cell Battery. A swallowed Button or Coin Cell battery can cause internal chemical burns in as little as two hours and lead to death. Dispose of used batteries immediately. Keep new and used batteries away from children. If you think batteries might have been swallowed or placed inside any part of the body, seek immediate medical attention.

DE
ACHTUNG: Dieses Produkt enthält eine Knopfzellenbatterie. Eine verschluckte Knopfzellenbatterie kann innere chemische Verbrennungen verursachen und in weniger als zwei Stunden zum Tod führen. Entsorge umgehend gebrauchte Batterien. Halte neue und gebrauchte Batterien von Kindern fern. Wenn du glaubst, dass Batterien verschluckt wurden oder sich in einem Körperteil befinden, hole umgehend medizinische Hilfe.

FR
AVERTISSEMENT : Ce produit contient une pile bouton. L'ingestion d'une pile bouton peut provoquer des brûlures chimiques internes en seulement deux heures et provoquer la mort. Jeter immédiatement les piles usagées. Conserver les piles neuves et usagées hors de portée des enfants. Si vous suspectez l'ingestion d'une pile ou sa présence où que ce soit à l'intérieur du corps, consultez immédiatement un médecin.

IT
ATTENZIONE: questo prodotto contiene una batteria a bottone. Se inghiottita, una batteria a bottone può causare ustioni chimiche interne in sole due ore, con possibile morte. Smaltire immediatamente le batterie usate. Tenere le batterie nuove e usate lontano dai bambini. Se si pensa che una batteria sia stata inghiottita o inserita in una parte del corpo, rivolgersi immediatamente a un medico.

NL
WAARSCHUWING: dit product bevat een knoopcelbatterij. Als een knoopcelbatterij wordt ingeslikt, kan deze binnen twee uur chemische brandwonden veroorzaken in het lichaam. Het inslikken van een dergelijke batterij kan zelfs leiden tot overlijden. Gooi gebruikte batterijen onmiddellijk weg. Bewaar nieuwe en gebruikte batterijen buiten bereik van kinderen. Als je denkt dat een kind batterijen heeft ingeslikt of ze in een lichaamsopening heeft gestopt, raadpleeg je direct een arts.

ES
ADVERTENCIA: Este producto contiene una pila de botón. Ingerir una pila de botón puede dar lugar a quemaduras químicas internas en tan sólo dos horas y provocar la muerte. Las pilas usadas deben desecharse inmediatamente. Mantenga las pilas nuevas y usadas fuera del alcance de los niños. Si sospecha de la ingestión o la introducción de pilas en cualquier parte del cuerpo, busque atención médica inmediatamente.

DA
ADVARSEL: Dette produkt indeholder et knap- eller møntcellebatteri. Hvis et knap- eller møntcellebatteri sluges, kan det forårsage indvendige ætsninger på blot to timer og medføre døden. Bortskaf brugte batterier omgående. Hold både nye og brugte batterier uden for børns rækkevidde. Hvis du har mistanke om, at batterierne kan være blevet slugt eller kommet ind i nogen del af kroppen, skal du omgående søge lægehjælp.

IS
VIDVÖRUN: Þessi vara inniheldur hnapparafhliðu eða flata rafhlöðu. Ef hnapparafhlaða eða flöt rafhlaða er gleypt getur hún valdið innvortis efnabruna á innan við tveimur klukkustundum og leitt til dauða. Fargaðu notuðum rafhlöðum tafarlaust. Geymdu nýjar og notaðar rafhlöður þar sem börn ná ekki til. Ef þú telur að rafhlöður hafi verið gleyptar eða á annan hátt komist inn í einhvern hluta líkamans skaltu tafarlaust leita lækniástoðar.

FI
VAROITUS: Tämä tuote sisältää pienen tai isokokaisen nappipariston. Nieltynä pieni tai isokokoinen nappiparisto voi aiheuttaa sisäisiä kemiallisia palovammoja jo kahden tunnin kuluessa ja johtaa kuolemaan. Käytetyt paristot on toimitettava heti keräyspisteeseen. Pidä uudet ja käytetyt paristot poissa lasten ulottuvilta. Jos epäilet jonkun nieleisseen pariston tai laittaneensa pariston kehoonsa, vie hänet välittömästi lääkäriin.

SV
VARNING: Denna produkt innehåller ett knapp- eller myntcells batteri. Förtäring av ett knapp- eller myntcells batteri kan orsaka inre kemiska brännskador på så kort tid som två timmar och leda till döden. Kassera förbrukade batterier omedelbart. Förvara nya och använda batterier utom räckhåll för barn. Om du tror att batterierna kan ha svalts eller placerats inuti någon del av kroppen, sök omedelbart läkarvård.

NO
ADVARSEL: Dette produktet inneholder et knapp- eller myntcellebatteri. Ved svelging kan knapp- eller myntcellebatterier gi kjemisk brannskade innvendig på bare to timer og føre til død. Brukte batterier skal avhendes øyeblikkelig. Nye og brukte batterier skal oppbevares utilgjengelig for barn. Hvis du tror at batterier har blitt svelget eller puttet inn andre steder i kroppen, må du kontakte lege øyeblikkelig.

PT
AVISO: Este produto contém uma pilha tipo botão ou moeda. Uma pilha tipo botão ou moeda que tenha sido engolida pode provocar queimaduras químicas internas em menos de duas horas e levar à morte. Elimine as pilhas usadas imediatamente. Mantenha as pilhas novas e usadas fora do alcance das crianças. Se pensa que as pilhas podem ter sido engolidas ou colocadas no interior de alguma parte do corpo, procure de imediato assistência médica.

EL
ΠΡΟΕΙΔΟΠΟΙΗΣΗ: Αυτό το προϊόν περιέχει μία Στρογγυλή Μπαταρία Μεγέθους Κουμπιού ή Κέρματος. Η κατάποση μιας Στρογγυλής Μπαταρίας Μεγέθους Κουμπιού ή Κέρματος μπορεί να προκαλέσει εσωτερικά χημικά εγκαύματα σε μόλις δύο ώρες και να οδηγήσει σε θάνατο. Πετάξτε αμέσως τις χρησιμοποιημένες μπαταρίες. Κρατήστε τις καινούργιες και τις χρησιμοποιημένες μπαταρίες μακριά από τα παιδιά. Εάν νομίζετε ότι κάποια μπαταρία έχει καταποθεί ή τοποθετηθεί εντός οποιουδήποτε μέρους του σώματος, ζητήστε αμέσως ιατρική βοήθεια.



JA

警告：本製品には、ボタン型またはコイン型の電池が使用されています。

ボタン型またはコイン型電池は誤飲すると2時間以内に体内で科学火傷を起こし、死に至る恐れがあります。使用済みの電池は直ちに廃棄してください。新しい電池および使用済み電池は、どちらもお子様の手の届かないところに保管してください。電池を誤飲した恐れがある、または電池が身体のごきに入った恐れがある場合は、直ちに医師の診察を受けてください。

ZH

警告：本品内含一颗纽扣电池。

吞咽的纽扣电池仅在两小时内就会引起体内化学灼伤并导致死亡！请立即处理使用过的电池。请将新、旧电池放置到儿童接触不到的地方。如果电池被不慎吞下，或被置入身体的任何一个部位，请立即就医！

KO

경고: 이 제품에는 버튼 또는 코인 셀 배터리가 포함되어 있습니다.

코인 셀 배터리를 삼킬 경우, 빠르면 2시간 이내에 체내에서 화학적 화상이 일어나고 심하면 사망에 이를 수 있습니다. 다 쓴 배터리는 즉시 폐기하십시오. 배터리를 어린이의 손에 닿지 않는 곳에 보관하십시오. 배터리를 삼켰거나 신체 어느 부위에든 들어간 것으로 판단될 경우, 즉각 의사의 도움을 구하십시오.

RU

ПРЕДОСТЕРЕЖЕНИЕ. Эта игрушка работает от батареек таблеточного или кнопочного типа.

Проглатывание батареек таблеточного или кнопочного типа может (в течение двух часов) вызвать химические ожоги внутренних органов и привести к летальному исходу. Своевременно утилизируйте использованные батарейки. Храните новые и использованные батарейки в местах, недоступных для детей. Если у вас есть основания полагать, что ребенок проглотил батарейку или она попала внутрь какой-либо части его тела, немедленно обратитесь за медицинской помощью.

PL

OSTRZEŻENIE: w tym produkcie znajduje się płaska okrągła bateria.

Pożknięcie takiej baterii może spowodować chemiczne oparzenia wewnętrzne już po dwóch godzinach, a także doprowadzić do śmierci. Gdy bateria się zużyje, należy ją natychmiast zutylizować. Nowe i używane baterie należy przechowywać z dala od dzieci. W przypadku stwierdzenia, że baterie mogły zostać pożknięte lub inaczej trafić do organizmu, należy natychmiast poszukać pomocy lekarskiej.

CZ

VAROVÁNÍ: Tento výrobek obsahuje knoflíkovou nebo mincovou baterii.

Spolknutí knoflíkové nebo mincové baterie může během pouhých 2 hodin způsobit vnitřní poleptání sliznice a v některých případech mít za následek smrt. Použité baterie ihned vyjměte a zlikvidujte. Nové i použité baterie uchovávejte mimo dosah dětí. V případě spolknutí či uvíznutí baterie v některé části těla okamžitě vyhledejte lékařskou pomoc.

SK

UPOZORNENIE: Tento produkt obsahuje gombíkovú alebo mincovú batériu.

Prehltnutie gombíkovvej alebo mincovej batérie môže spôsobiť vnútorné chemické popáleniny už do dvoch hodín a viesť k úmrtiu. Použitú batériu ihneď vyhodte. Nové aj použité batérie uchovávajte mimo dosahu detí. Ak si myslíte, že mohlo dôjsť k prehltnutiu batérie alebo sa batéria mohla dostať do vnútra ktorejkoľvek časti tela, okamžite vyhľadajte lekársku pomoc.

HU

FIGYELMEZTETÉS: Ez a termék gombelemet illetve lapos gombelemet tartalmaz!

A lenyelt gombelem vagy lapos gombelem akár két óra alatt is belső vegyi sérüléseket okozhat, ami halálhoz vezethet. Az elhasznált elemeket azonnal dobja ki! Az új és a használt elemeket ne adja gyermekek kezébe! Ha úgy gondolja, hogy valaki lenyelt egy elemet, vagy bekerült valakinek valamely testrészébe, akkor azonnal kérjen orvosi segítséget!

UA

ОБЕРЕЖНО. Продукт містить мініатюрну батарейку типу «таблетка».

Якщо проковтнути мініатюрну батарейку, вона може спричинити внутрішні хімічні опіки протягом двох годин і призвести до смерті. Негайно утилізуйте використані батарейки. Зберігайте нові та використані батарейки недосяжними для дітей. Якщо вам здається, що дитина проковтнула батарейку чи вона опинилася в будь-якій частині тіла дитини, негайно зверніться до лікаря.

HR

UPOZORENJE: Ovaj proizvod sadrži gumbastu bateriju ili bateriju oblika kovanice.

Ako se gumbasta baterija ili baterija oblika kovanice proguta, za samo dva sata može uzrokovati unutarnje kemijske opekline i izazvati smrt. Iskorištene baterije odmah odložite u otpad. Čuvajte nove i stare baterije dalje od djece. Ako mislite da je baterija progutana ili je dospjela u bilo koji dijela tijela, odmah zatražite liječničku pomoć.

SR

УПОЗОРЕЊЕ: Овај производ садржи дугмасту батерију.

Прогутана дугмаста батерија може да доведе до интерних хемијских опекотина већ за два сата и доводи до смрти. Одмах одложите искоришћене батерије у отпад. Чувајте нове и искоришћене батерије ван домаћаја деце. Ако мислите да је дошло до гутања батерија или стављања у било који део тела, одмах потражите помоћ лекара.

MK

ПРЕДУПРЕДУВАЊЕ: Овој производ садржи батерија тип копче или тип монета.

Проголтувањето на батерија тип копче или тип монета може да предизвика внатрешно хемиско горење во рок од два часа и да доведе до смрт. Исфрлете ги веднаш искористените батери. Држете ги новите и користените батери подалеку од деца. Ако мислите дека е можно батериите да се проголтани или поставени во кој било дел на телото, веднаш побарајте медицинска помош.



SL
OPOZORILO: Ta izdelek vsebuje gumbasto baterijo.
Če oseba požre gumbasto baterijo, lahko to povzroči kemične opekline notranjih organov že v dveh urah po zaužitju. Tovrstne poškodbe lahko vodijo v smrt. Iztrošene baterije takoj zavržite. Pazite, da nove ali iztrošene baterije ne bodo v dosegu otrok. Če menite, da je oseba zaužila baterijo ali si jo vstavila v kateri koli del telesa, takoj poiščite zdravniško pomoč.

RO
AVERTIZARE: Acest produs conține o baterie de tip pastilă.
Înghițirea unei baterii de tip pastilă poate cauza arsuri chimice interne în doar două ore, ducând la deces. Debarasați-vă imediat de bateriile uzate. Nu lăsați bateriile noi și uzate la îndemâna copiilor. Dacă credeți că bateriile ar fi putut fi înghițite sau ar fi putut ajunge în interiorul oricărei părți a corpului, solicitați imediat asistență medicală.

BG
ПРЕДУПРЕЖДЕНИЕ: Този продукт съдържа батерия тип „копче“ или „монета“.
При поглъщане батериите тип „копче“ или „монета“ могат да предизвикат вътрешни химически изгаряния в рамките на по-малко от два часа и да доведат до смърт. Незабавно изхвърляйте използваните батерии. Дръжте новите и стари батерии далеч от деца. Ако смятате, че е възможно батериите да са били погълнати или да са попаднали където и да е вътре в тялото, потърсете незабавно медицинска помощ.

LV
BRĪDINĀJUMS. Šim produktam ir pogas jeb monētas tipa akumulators.
Ja pogas jeb monētas tipa akumulators tiek norīts, tas jau divu stundu laikā var izraisīt iekšējus ķīmiskus apdegumus un izraisīt nāvi. Nekavējoties utilizējiet izlietotos akumulatorus. Jaunus un lietotus akumulatorus glabājiet bērniem nepieejamā vietā. Ja uzskatāt, ka akumulators varētu būt norīts vai ievietots kādā ķermeņa daļā, nekavējoties vērsieties pēc medicīniskās palīdzības.

ET
HOIATUS! See toode sisaldab nõõp- või müntpatareid.
Alla neelatud nõõp- või müntpatarei võib tekitada sisemisi keemilisi põletusi kõigest kahe tunniga ning põhjustada surma. Kõrvaldage kasutatud patareid viivitamatult. Hoidke uusi ja kasutatud patareisid lastele kättesaamatus kohas. Kui arvate, et keegi on patareid alla neelanud või need on sattunud mõnda kehaosasse, pöörduge kohe arsti poole.

LT
JSPĖJIMAS. Šiame gaminyje yra sagos arba monetos formos baterija.
Praryta sagos arba monetos formos baterija gali sukelti vidinius cheminius nudeginimus greičiau nei per dvi valandas ir galiausiai sukelti mirtį. Panaudotas baterijas nedelsiant utilizuokite. Naujas ir panaudotas baterijas laikykite atokiau nuo vaikų. Jei manote, kad vaikas galėjo praryti arba įsprausti bateriją sau į kūną, nedelsdami kreipkitės medicininės pagalbos.

TR
UYARI: Bu ürün bir düğme pil içerir.
Yutulmuş düğme pil, iki saat gibi kısa bir sürede iç kimyasal yanıklara neden olabilir ve ölüme yol açabilir. Kullanılmış pilleri derhal atın. Yeni ve kullanılmıř pilleri çocuklardan uzak tutun. Pillerin yutulmuş ya da vücudun başka bir yerine sokulmuş olabileceđini düşünüyorsanız derhal doktora başvurun.

AR
تحتوي هذا المنتج على بطارية خلايا قمرصبة أو بطارية خلايا على شكل عملة.
قد يؤدي ابتلاع بطارية خلايا قمرصبة أو بطارية خلايا على شكل عملة إلى حدوث حروق كيميائية داخلية خلال فترة قصيرة لا تتجاوز ساعتين وقد يؤدي إلى الوفاة. يرجى التخلص من البطاريات المستعملة على الفور. مع الاحتفاظ بالبطاريات الجديدة والمستعملة بعيداً عن متناول الأطفال. إذا كنت تعتقد أن البطاريات تم ابتلاعها أو إدخالها إلى أي جزء من أجزاء الجسم، فاطلب المساعدة الطبية على الفور.

ID
PERINGATAN: Produk ini berisi Baterai Sel Kancing.
Baterai Sel Kancing yang tertelan dapat mengakibatkan luka bakar kimiawi dalam tubuh minimal setelah dua jam dan dapat mengakibatkan kematian. Segera buang baterai yang sudah tidak digunakan. Jauhkan baterai baru maupun bekas dari jangkauan anak-anak. Jika Anda curiga baterai telah tertelan atau masuk ke dalam tubuh, segeralah minta bantuan dokter.

MS
AMARAN: Produk ini mengandungi Bateri Sel Butang atau Syiling.
Tertelan bateri Sel Butang atau Syiling boleh mengakibatkan lecuran kimia dalaman dalam tempoh sekurang-kurangnya dua jam dan menyebabkan kematian. Buang bateri terpakai dengan serta-merta. Jauhkan bateri baharu dan terpakai daripada kanak-kanak. Jika anda mendapati bateri mungkin telah ditelan atau termasuk ke dalam mana-mana bahagian badan, dapatkan rawatan perubatan dengan segera.

EN Please retain the leaflet and packaging as they contain important information
DE Broschüre und Verpackung bitte aufbewahren, sie enthalten wichtige Informationen
FR Veuillez conserver le dépliant et l'emballage, car ils contiennent des informations importantes
IT Conserva l'opuscolo e la confezione in quanto contengono informazioni importanti
NL Bewaar a.u.b. de folder en verpakking; die bevatten belangrijke informatie
ES Conserve el folleto y el embalaje; contienen información importante
DA Gem hæftet og emballagen, da de indeholder vigtige oplysninger
IS Geymið bæklinginn og umbúðirnar þar sem þau innihalda mikilvægar upplýsingar
FI Säilytä esite ja pakkaus, koska ne sisältävät tärkeää tietoa
SV Spara broschyren och förpackningen eftersom de innehåller viktig information
NO Hefte og emballasjen inneholder viktig informasjon og skal beholdes
PT Por favor guarde o folheto e a embalagem, pois contém informação importante
EL Κρατήστε το φυλλάδιο και τη συσκευασία γιατί περιέχουν σημαντικές πληροφορίες
JA 説明書とパッケージには重要な情報が含まれていますので保管しておいてください
ZH 说明书和包装均包含重要信息, 请妥善保存
KO 중요한 정보가 담겨 있으므로 리플릿과 포장을 보관해주세요
RU Пожалуйста, сохраните эту брошюру и упаковку, поскольку они содержат важную информацию
PL Prosimy zachować ulotkę i opakowanie, ponieważ zawierają one ważne informacje
CZ Ponechte si prosím leták i obal, neboť obsahují důležité informace
SK Ponechajte si prosím leták aj obal, pretože obsahujú dôležité informácie
HU Kérjük, őrizze meg a szórólapot és a csomagolást, mert fontos tudnivalókat tartalmaznak
UA Будь ласка, зберігайте вкладиш та упаковку, оскільки вони містять важливу інформацію
HR Spremite letak i ambalažu jer sadrže važne obavijesti
SR Молимо да сачувате упутство и паковање јер се на њима налазе важне информације
MK Чувајте ги брошурата и амбалажата бидејќи содржат важна информација
SL Prosimo, da brošurico in embalažo shranite, saj vključujeta pomembne informacije
RO Vă rugăm să păstrați prospectul și ambalajul întrucât conțin informații importante
BG Запазете листовката и опаковката, тъй като съдържат важна информация
LV Lūdzu, saglabājiet bukletu un iepakojumu, jo uz tā ir norādīta svarīga informācija
ET Hoidke infoleht ja pakend alles, sest nendele on märgitud oluline teave
LT Išsaugokite informacinį lapelį ir pakuotę, nes ant jų pateikiama svarbi informacija
TR Önemli bilgiler içerdiği için broşürü ve ambalajı saklayın
AR الرجاء الاحتفاظ بالنشرة والغلاف لاحتوائهما على معلومات هامة
ID Harap simpan brosur dan kemasan ini karena berisi informasi penting
MS Sila simpan risalah dan pembungkusan kerana ia mengandungi maklumat penting

LEGO System A/S
Aastvej 1
DK-7190 Billund



EN
Protect the environment by not disposing of this product with your household waste.
Check with your local authority for recycling advice and facilities. Penalties may apply for improper disposal.

DE
Schützen Sie die Umwelt und entsorgen Sie dieses Produkt nicht mit Ihrem Hausmüll.
Informationen zu Recycling-Möglichkeiten erhalten Sie bei den örtlichen Behörden. Bei unsachgemäßer Entsorgung können Strafen verhängt werden.

FR
Protégez l'environnement : ne jetez pas ce produit avec vos autres déchets ménagers.
Contactez les autorités locales pour obtenir des informations sur le recyclage et connaître les points de collecte. Des sanctions peuvent être appliquées en cas d'élimination inappropriée.



IT
Proteggi l'ambiente! Non smaltire questo prodotto con i rifiuti domestici.
Per consulenza sul riciclaggio dei rifiuti e le strutture di riciclaggio, rivolgersi alle proprie autorità locali. Uno smaltimento improprio può comportare sanzioni.

NL
Bescherm het milieu: gooi dit product niet samen met het andere huisvuil weg.
Raadpleeg de plaatselijke instanties voor locaties van milieustations en advies over hergebruik. In geval van onjuiste verwijdering kunnen boetes worden opgelegd.

ES
Proteja el medio ambiente no deshaciéndose de este producto junto con sus residuos domésticos.
Solicite asesoramiento e información sobre instalaciones de reciclaje a las autoridades locales. La eliminación inadecuada puede ser objeto de sanciones.

DA
Beskyt miljøet! Smid ikke dette produkt ud sammen med husholdningsaffaldet.
Få vejledning om genbrug og genbrugsstationer hos din kommune.
Ukorrekt bortskaffelse kan medføre bøde eller straf.

IS
Stuðlið að umhverfisvernd með því að farga þessari vöru ekki með heimilissorpi.
Leitið upplýsinga um endurvinnslu- og förgunarstaði hjá yfirvöldum á hverjum stað. Viðurlögum kann að vera beitt ef förgun er ekki með réttum hætti.

FI
Tämä tuote on hävitettävä ympäristöstävällisesti ja erillään muusta talousjätteestä.
Tietoja kierrätyksestä ja keräyspisteiden sijainnista saat paikkakuntasi teknisestä virastosta. Epäasianmukaisesta hävittämisestä saattaa aiheutua seuraamuksia.

SV
Skydda miljön genom att inte kasta denna produkt bland ditt hushållsavfall.
Kontakta din kommun för frågor om återvinning och miljöstationer. Påföljder kan tillkomma för felaktig avyttring.

NO
Beskytt miljøet. Ikke kast dette produktet i husholdningsavfallet.
Kontakt kommunen for veiledning om gjenbruk og miljøstasjoner. Feil avfallshåndtering kan være straffbart.

PT
Proteja o ambiente não eliminando este produto com o seu lixo doméstico.
Consulte as autoridades locais para informação sobre reciclagem e sistemas de recolha. Podem ser aplicadas coimas por eliminação inadequada.

EL
Προστατέψτε το περιβάλλον. Μην πετάτε αυτό το προϊόν μαζί με τα συνηθισμένα οικιακά απορρίμματα.
Επικοινωνήστε με τις τοπικές αρχές σχετικά με συμβουλές και εγκαταστάσεις ανακύκλωσης. Ενδέχεται να επιβάλλονται κυρώσεις για ακατάλληλη διάθεση απορριμμάτων.

JA
環境保護のため、本製品は家庭ごみとは別に処分してください。
リサイクルに関する指示や施設については、お住まいの地方自治体にお問い合わせください。不適切な廃棄を行った場合、罰則が適用されることがあります。

ZH
注意保护环境，请勿将本产品与生活垃圾一起丢弃处理。
请咨询当地相关部门，了解与回收相关的设施与建议。
处理不当可能会导致处罚。

KO
환경 보호를 위해 이 제품을 생활폐기물과 함께 버리지 마십시오.
재활용 방법 및 시설에 관한 사항은 현지 관계 당국에 문의하십시오. 부적절하게 폐기할 경우 벌칙이 부과될 수 있습니다.

RU
Позаботьтесь об окружающей среде: не утилизируйте этот продукт вместе с бытовым мусором.
Узнайте в органах местного самоуправления правила вторичной переработки и утилизации таких отходов.
В случае ненадлежащей утилизации могут быть наложены штрафы.

PL
Aby chronić środowisko naturalne, nie należy wyrzucać tego produktu wraz z odpadkami z gospodarstwa domowego.
W celu uzyskania wskazówek dotyczących recyklingu oraz adresów zakładów należy skontaktować się z lokalnym urzędem.
Za nieprzestrzeganie zasad związanych z utylizacją odpadów grożą kary.



CZ

Nevyhazujte tento produkt do domácího odpadu, chraňte životní prostředí. Zjistěte si prosím u místních úřadů možnosti recyklace a dostupná zařízení. Nesprávná likvidace může být pokutována.

SK

Nevyhádzajte tento produkt do domáceho odpadu, chráňte životné prostredie. Zistite si na miestnych úradoch možnosti recyklácie a dostupné zariadenia. Za nesprávnu likvidáciu môžu byť uložené sankcie.

HU

Környezetét óvja, ha ettől a terméktől nem a háztartási hulladékkal együtt válik meg. Érdeklődjék a lakóhelyéhez közel eső hatóságnál az újrahasznosítás módjáról és lehetőségeiről. A nem megfelelő hulladékéelhelyezésért büntetés járhat.

UA

Допоможіть захистити довкілля: не утилізуйте цей виріб разом із побутовим сміттям. Вказівки з утилізації та відомості про пункти прийому з'ясуйте в місцевих компетентних органах. У разі неналежної утилізації можуть застосовуватися штрафи.

HR

Zaštitite okoliš tako da ovaj proizvod ne odložite u otpad zajedno s kućanskim otpadom. Od lokalnih vlasti zatražite savjet ili informacije o pogonima za recikliranje. Moguća je kazna za nepropisno zbrinjavanje.

SR

Zaštitite životnu sredinu tako što nećete da odlažete ovaj proizvod sa kućnim otpadom. Raspitajte se kod lokalnog nadležnog organa o načinu reciklaže i o sabirnom centru. U slučaju nepravilnog odlaganja u otpad, mogu biti izrečene kazne.

MK

Zaštitite ja okolinata tako što nema da se oslobodite od proizvodot so domashniot otpad. Konsultirajte se so lokalnite vlasti za da doznaete za sovetite i objekтите za recikliranje. Vozmožno e da bidat primeneti kazni za nepravilno isfrlanje.

SL

Zaščitite okolje! Okolje varujte tako, da tega izdelka ne zavrzete skupaj z gospodinjiskimi odpadki. Pri krajevni upravi preverite, kakšne možnosti in kateri obrati za recikliranje obstajajo v vaši okolici. Za nepravilno odlaganje odpadkov vas lahko doleti kazen.

RO

Protejați mediul înconjurător și nu vă debarașiți de acest produs împreună cu deșeurile menajere. Consultați autoritățile locale pentru îndrumări și facilități de reciclare. Dezafectarea necorespunzătoare poate atrage sancțiuni.

BG

Защитете околната среда и не изхвърляйте този продукт заедно с битовите си отпадъци. Свържете се с местните власти относно съвети и съоръжения за рециклиране. Възможно е да има глоби за неправилно изхвърляне.

LV

Lai saudzētu vidi, neizmetiet šo izstrādājumu kopā ar sadzīves atkritumiem. Vērsieties vietējās varas iestādēs, lai noskaidrotu, kur un kā tas nododams pārstrādei. Par neatbilstošu likvidēšanu var tikt piemērots sods.

ET

Keskkonda saate kaitsta nii, et ei kõrvalda seda toodet koos olmejäätmetega. Nõuandeid toote taaskasutusse võtmise ja ümbertöötlemispunktide kohta saate asjaomaselt kohalikul asutuselt. Nõuetele mittevastav kasutuselt kõrvaldamine võib kaasa tuua trahvid.

LT

Saugokite aplinką: nemeskite šio produkto kartu su buitinėmis atliekomis. Atsižvelkite į savo vietos valdžios rekomendacijas dėl pakartotinio panaudojimo ir sąlygas. Už netinkamą šalinimą gali būti taikomos baudos.

TR

Bu ürünü, evsel atıklarla birlikte atmayarak çevreyi koruyun. Geri dönüşüm tavsiyeleri ve tesisler hakkında bilgi için yerel yönetimle iletişim kurun. Uygunsuz atılması durumunda cezalar uygulanabilir.

AR

احم البيئة بعدم التخلص من هذا المنتج مع المخلفات المنزلية. استشر السلطة المحلية لديك للحصول على نصح بخصوص إعادة تدوير المخلفات ومرافقه. قد يتم تطبيق عقوبات على التخلص غير السليم.

ID

Jagalah lingkungan dengan tidak membuang produk ini bersama sampah rumah tangga Anda. Periksa peraturan pemerintah setempat tentang saran dan fasilitas daur ulang. Pembuangan yang tidak sesuai ketentuan dapat dikenakan denda.

MS

Lindungi alam sekitar dengan tidak melupuskan produk ini bersama sisa isi rumah anda. Rujuk pihak berkuasa tempatan anda tentang nasihat dan kemudahan kitar semula. Penalti boleh dikenakan untuk pelupusan yang tidak wajar.

2x
6240495

4x
614101

1x
4651445

3x
6177114

4x
654101

2x
6330191

1x
6261372

2x
6326680

2x
6215107

1x
4508143

1x
6289797

1x
6006221

2x
6332157

4x
6353196

5x
4179771

2x
4224793

4x
6212758

1x
6405054

3x
4666579

4x
4650647

4x
6351806

1x
4107623

10x
4523145

4x
6092587

2x
4205107

5x
4114026

1x
4113917

5x
6046907

4x
6249809

3x
6321305

2x
4124455

2x
6131896

2x
4121921

3x
6211966

1x
6405052

1x
6405067

1x
4666999

1x
6272116

1x
6331945

1x
6405114

3x
6271820

11x
6378120

2x
6173126

4x
4142865

1x
6102138

1x
6331864

1x
6129995

2x
6130004

1x
370321

1x
4206482

1x
6224999

15x
6299413

2x
302224

4x
6347698

1x
4544151

3x
6271828

2x
4639693

1x
6331084

1x
6186675

10x
6344752

2x
6056234

2x
6371584

2x
6405102

2x
4177431

4x
6338428

19x
6279875

1x
4198367

4x
6344999

8x
6092585

2x
6173119

1x
4593678

4x
302326

1x
6000650

3x
6234806

4x
383126

1x
6313520

4x
6276875

4x
4209003

4x
4209013

1x
6279021

1x
6192346

2x
368026

1x
6089119

3x
6052126

2x
4142822

4x 362326
 2x 4558170
 5x 370526
 2x 300226
 2x 6271825
 4x 243126
 2x 371026
 1x 4515350
 1x 4560182
 4x 302026
 7x 300126
 1x 4142135
 2x 6039194

4

5

4x 379526
 1x 6318582
 2x 370726
 13x 416226
 1x 346026
 4x 300826
 1x 6276835
 1x 6244698
 3x 303426
 5x 6037390

8

2x 6271152
 2x 447726
 5x 4617860
 2x 4514845
 4x 303026
 12x 244526
 2x 6147030
 2x 428226

1x 6338221
 2x 6135287
 2x 4121969
 3x 6270003
 1x 371028
 3x 243128
 1x 6177783
 1x 6235080
 16x 6182261
 5x 6347460
 9x 6143431
 1x 6240515
 5x 6213778
 6x 6295358

1x 6213779
 15x 6334128
 1x 6213787
 4x 6344866
 2x 6092592
 10x 6175572
 4x 6322841
 1x 4549436
 2x 6055172
 11x 6001824
 4x 6270111
 1x 6257533
 1x 6397840
 6x 6101254
 2x 6093064
 1x 6354068

8x 4646577
 14x 6310835
 17x 4521914
 6x 4496699
 24x 4528604
 1x 6335228
 12x 4507045
 11x 4550168
 4x 4255416
 2x 6015452
 3x 6035540
 2x 6328307
 2x 6001822
 1x 6175927
 4x 4626904

2x 4267874
 3x 4247145
 1x 4247151
 1x 4550329
 1x 4246957
 14x 6400754
 10x 6369999
 1x 6269984
 4x 6335233
 15x 6262238
 1x 6314353
 1x 6170468

1x 6341968
10x 4211288
4x 6329114
1x 6401395
2x 6078605
8x 4531751
2x 6311210
1x 4211252
1x 6173132
1x 6270078
2x 6382326
1x 6396389
2x 6075208
1x 6280160
1x 4216695

2x 6135494
3x 6326087
1x 6383996
1x 6116613
2x 4538252
1x 6372430
12x 6284071
32x 6168647
8x 6271165
1x 6252203
3x 4211483
15x 4211399
10x 4521921
1x 6262085
2x 6336539
6x 4211389

3

3

5

5

20x 4211474
2x 6061702
1x 6186013
2x 6267495
1x 6248078
1x 4211758
1x 4211375
3x 6281998
2x 6248890
1x 4211732
2x 4540203
1x 4550325
5x 4211807
2x 6211917
1x 4227657

3x 6266251
4x 4642934
4x 6066097
16x 4211388
13x 4211398
1x 4617170
5x 4211541
4x 6168633
1x 6261353
3x 6321770
4x 4211437
4x 4211440
1x 6170387
1x 4211614
10x 6123809

9x 4211494
5x 6383177
7x 4216248
8x 6117967
1x 4654582
9x 4211568
2x 6198932
5x 4211413
4x 4211397
4x 4211349
4x 4567448
12x 4211353
2x 4234535
1x 6273227

2x 4211436
3x 4211815
1x 6315900
6x 4654577
1x 4515369
7x 4211428
7x 4211429
2x 4211488
5x 4211394
1x 4211445
2x 4211395
1x 4211639
1x 6330090

1x 4211651
1x 6039346
1x 4211393
6x 4243797
1x 4160560
2x 6279885
2x 4211442
4x 4211392
2x 4211406
1x 6037399

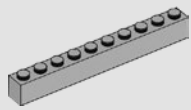

2x
4211521



1x
4211462

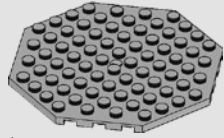

1x
6034493



1x
6385882



2x
4529240



3x
6231765



3x
6100030



1x
4211029



8x
4210719



13x
4558955



6x
4210848



2x
4180811



3x
6344022



3x
4211044



9x
4211098



14x
6228923



6x
4210639



2x
6336390



4x
6360111



1x
6321350



1x
4210782



4x
6076203



1x
6092666



1x
4211095



1x
6178919



11x
6327414



1x
6146225



15x
6168776



6x
6013658



2x
6092572



4x
6335306



15x
4211052



22x
4211063



14x
4211088



8x
6019987



6x
4211111



3x
6069164



4x
4211135



1x
4500975



1x
4624186



2x
6308045



6x
6262025



11x
4210795



2x
4586562



2x
4209014

1x
6273715

17x
6126083

6x
6309059

9x
4211055

7x
4211094

1x
6177079

1x
4211054

2x
4211060

12x
4211109

7x
4210635

3x
4521187

1x
4552349

3x
4211104

4x
4211133

3x
6186635

1x
4568734

1x
6172811

1x
6324639

1x
6413276

2x
6187008

8x
6351616

4x
4211043

3x
4211105

1x
6405646

1x
6083620

3x
4211001

5x
4213607

2x
4211053

1x
4211103

5x
6257592

3x
4535930

2x
6008715

1x
4210897

1x
4560184

1x
4210637

3x
4210753

2x
4210686

1x
6005321

1x
6075060

1x
6133811

2x
4629920

3x
4211056

1x
4211100

2x
4210651

1x
4495931

1x
4499858

5x
4210998

4

5

7

8

6x
4211008

2x
4211099

1x
4210997

1x
4645730

1x
4211107

2x
4211061

1x
6400752

1x
4603472

2x
6133611

2x
4210798

1x
4211122

1x
4211137

3x
4210706

1x
4542576

3x
4256149

7x
4256828

1x
6331600

1x
6331443

1x
6331364

1x
6265670

3x
6134197

1x
6405139

15

11

9

1x
6332374

3x
6218089

1x
6328363

2x
6167690

4x
6057986

3x
6314190

2x
6380634

1x
6076674

8x
4569382

9x
4656783

2x
6360296

2x
6218360

1x
6313599

7x
6056383

1x
6058085

4x
6177535

1x
6192922

3x
6055309

1x
6102995

1x
6295464

5x
6214214

1x
6393193

3x
6323689

20x
6284595

7x
6285465

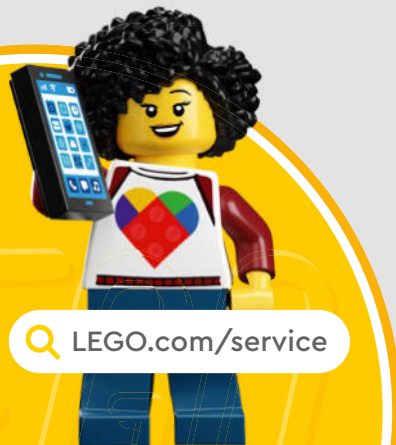

 [LEGO.com/service](https://www.LEGO.com/service)



YOU COULD WIN



YOU COULD WIN

Your feedback will help shape the future development of this product series.

Visit:

DU KÖNNTEST GEWINNEN

Dein Feedback trägt zur Weiterentwicklung dieser Produktreihe bei.

Geh auf:

VOUS POURRIEZ GAGNER

Vos commentaires nous aideront à concevoir les futurs produits de cette gamme.

Visitez :

POTRESTI VINCERE TU

La tua opinione ci aiuterà a migliorare la creazione futura di questa linea di prodotti.

Visita:

PUEDES GANAR

Tu opinión contribuirá al futuro de esta serie de productos.

Visita:

轻松获奖

您的反馈将有助于我们在今后改进本产品系列。

请访问:

LEGO.com/productfeedback

You also have the chance to win a LEGO® set.

Terms and conditions apply.*

Außerdem hast du die Chance, ein LEGO® Set zu gewinnen.

Es gelten die Teilnahmebedingungen.*

Vous pourriez également gagner un ensemble LEGO®.

Des conditions s'appliquent.*

Hai anche la possibilità di vincere un set LEGO®.

Termini e condizioni sono applicabili.*

También tienes la oportunidad de ganar un set LEGO®.

Aplican términos y condiciones.*

您还有机会赢取乐高®套装。

条款和条件适用。*

*[LEGO.com/productfeedback-terms](https://www.lego.com/productfeedback-terms)

